

YOKOGAWA 

DLM 2000 Series

Mixed Signal Oscilloscope



Lineup includes 200 MHz, 350 MHz, 500 MHz bandwidth models

Lightweight and compact

Large 8.4-inch LCD display

Long memory: Up to 125M points (with /M2 option)

High speed sampling: Up to 2.5 GS/s (1.25 GS/s with 4 ch)

DLM 2000

For more information, go to
tmi.yokogawa.com
Test & Measurement Instruments



 3-Year Warranty 

Bulletin 7101-00E

Flexible inputs and flexible performance

Easy-to-Use & Easy-to-See

Easy to use. Portrait body + large screen makes display easy to see.

We elevated the large (8.4-inch) LCD screen up into the line of sight. Also, the portrait format saves space on the desk or test bench. A compact personal oscilloscope designed for easy viewing and ease of use.

Measured values can be accurately read on the 0.1 div sub grid display.

Large screen in a compact body

Footprint is approximately 2/3 the size of an 8 1/2 x 11 sheet of paper (depth of approximately 8)



Vertical Position and Scale

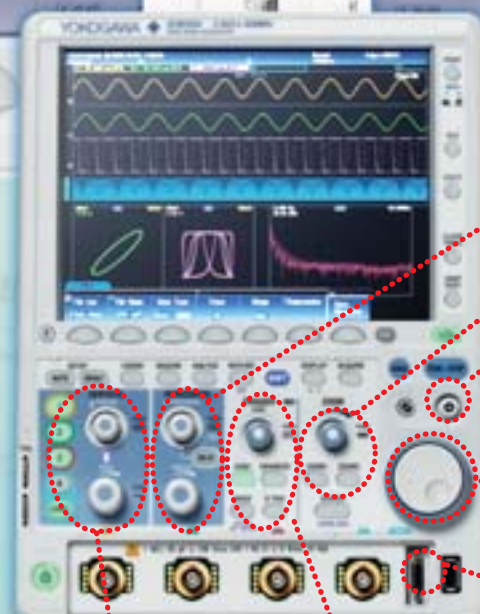

Trigger Control Keys and Level Knob

Horizontal Position and Scale Knob

Dedicated Zoom Keys

Four-Direction Selector Button

Select key moves the cursor up/down/left/right

Jog Shuttle and Rotary Knob

Logic input connector

Signal observation on 4 channels or more...

Flexible MSO Input - Capture a mixed signals of analog and logic signals -

Four channels is not sufficient to view the functioning of digital control circuits. The DLM2000 series converts 4 ch of analog input to 8-bit logic, and functions as a 3 ch analog + 8-bit logic MSO (mixed signal oscilloscope).

3 ch analog + 8-bit logic

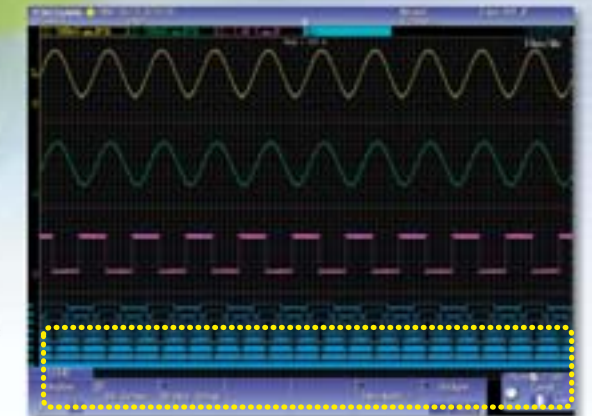

The performance of up to 11 inputs by converting to logic

Using logic input, up to 11 input signals can be observed simultaneously as 3 ch of analog and 8-bit logic. It is not only possible to use logic input for observation of data and control signals, or as a trigger source, but also for logic input analysis of I²C and SPI serial busses.

Logic probe for the DLM2000



Fast data processing with ScopeCORE

With our proprietary ScopeCORE fast data processing IC, real time display is possible even when simultaneously measuring multichannel signals of 11 inputs.



ScopeCORE fast data processing IC

DLM2000 Series Lineup

Item	Model	DLM2022 710105	DLM2032 710115	DLM2052 710125	DLM2024 710110	DLM2034 710120	DLM2054 710130
Analog input channels		2			4*		
Logic input		-			8bit		
Maximum sampling rate		2.5 GS/s (interleave ON)					
Frequency characteristics		200 MHz	350 MHz	500 MHz	200 MHz	350 MHz	500 MHz
Maximum record length		62.5 Mpoints (Single measurement, memory length: M1S, interleave ON)			125 Mpoints (Single measurement, memory length: M2, interleave ON)		

* Or 3 channels when using logic input.

Sophisticated waveform acquisition engine

With long memory and the History function, you'll never miss an historical waveform. A variety of trigger functions reliably capture the waveforms you want.



▶ Large capacity (125 Mpoint) memory enables long-duration measurements

For taking 2 ch measurements in Single mode, you can add the /M2 memory expansion option giving you up to 125 Mpoints of large memory capacity. 10,000 Hz signals can be recorded for up to 5,000 seconds. Even at a sampling rate of 1.25 GS/s, waveforms down to 0.1 seconds can be captured.

	Continuous Measurement		Single-Shot Measurement	
	2 ch, 4 ch same	With 4 ch (With 2ch for DLM20x2)	With 2 ch (With 1ch for DLM20x2)	With 2 ch (With 1ch for DLM20x2)
Standard	1.25 Mpoints	6.25 Mpoints	12.5 Mpoints	12.5 Mpoints
/M1, /M1S memory option	6.25 Mpoints	25 Mpoints	62.5 Mpoints	62.5 Mpoints
/M2 memory option	12.5 Mpoints	62.5 Mpoints	125 Mpoints	125 Mpoints

Note) The /M1, /M2 memory expansion options are only available on 4ch models. The /M1S option is only available on 2ch models.

▶ You can replay waveforms later on, so you'll never miss an abnormal waveform - History Function -



With the DLM2000 series, up to 20,000 previously captured waveforms can be saved in the acquisition memory. With the History function, you can display just one or all of the previously captured waveforms (history waveforms) on screen. You can also perform cursor measurement, computation, and other operations on history waveforms. Using the History function, you can analyze rarely-occurring abnormal signals.

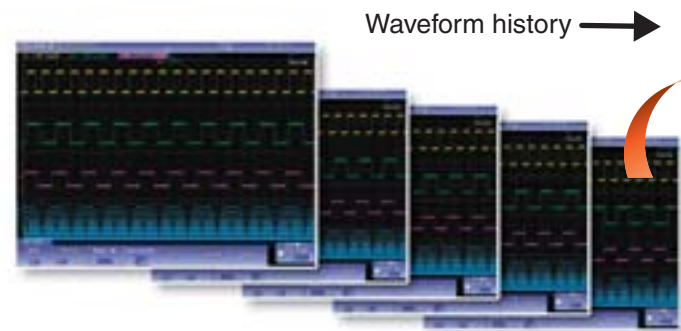

History search function

You can search the up to 20,000 previously captured waveforms for history waveforms that meet certain conditions. You can perform cursor measurement and other analyses on the found waveforms.

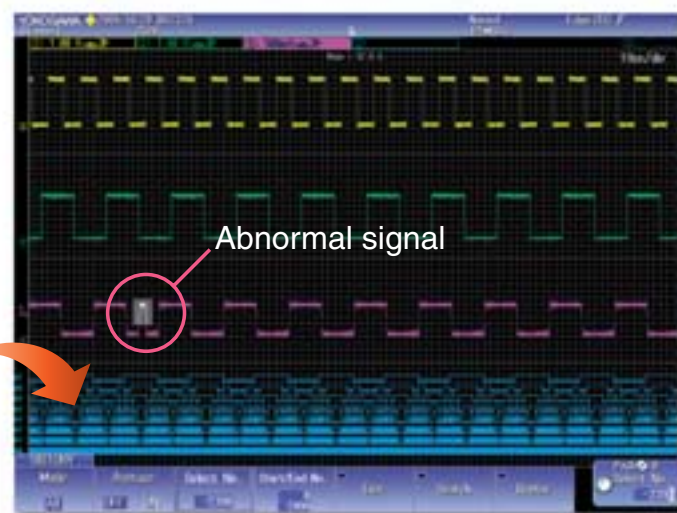





Replay function

Waveforms can be displayed in order, one at a time, by using the rotary knob. With the Replay function, history waveforms can be automatically played back, paused, fast-forwarded, and rewind.

▶ Trigger Function capturing combined analog/digital complex waveforms

The DLM2000 series comes with a variety of easy-to-configure triggers combining analog and logic inputs such as edge, enhanced, and B triggers.

- Edge trigger**
 - Edge
- Enhanced triggers**
 - Edge OR 
 - Edge (qualified) 
 - State 
 - Pulse width 
 - State width 
 - Serial: (optional)
CAN/LIN/UART/I2C/SPI : (standard) user-defined
 - TV : NTSC/PAL/SDTV/HDTV/user defined
- B triggers**
 - A Delay B
 - A to B(n)
 - Dual bus (combination trigger of 2 serial busses)

Trigger function example

◆ A to B(n) trigger:

Example: Trigger on the 7th edge of signal on B. This is effective for measurements with shifted timing, such as non-standard video signal vertical/horizontal periods or motor reference position pulses and drive pulses.

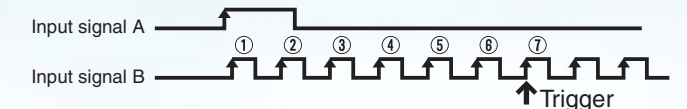

◆ Serial pattern trigger (user defined):

Example : Trigger on an arbitrarily set pattern of up to 128 bits. This is effective for detecting ID/Data and other portions of proprietary communication formats.

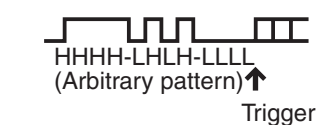

◆ Dual pulse trigger:

Example: Trigger on a combination of CAN and LIN bus triggers. I2C + SPI bus triggers, and other combinations are possible.

Trigger when either LIN or CAN bus signal conditions become true

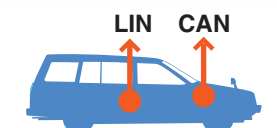

▶ Real time filter with optimum noise reduction supports a wide range of frequencies (from 8 kHz to 200 MHz)

The DLM2000 series has two types of filters, one processed at the input circuit and one based on MATH functions. These filters are effective for rejecting unwanted signals, allowing observation of only the desired bandwidths.

Real time filters

Each channel has 14 low pass filters available from 8 kHz to 200 MHz. Waveforms of limited bandwidths are stored in internal memory.

Cutoff frequencies : 200 MHz, 100 MHz, 20 MHz, 10 MHz, 5 MHz, 2 MHz, 1 MHz, 500 kHz, 250 kHz, 125 kHz, 62.5 kHz, 32 kHz, 16 kHz, and 8 kHz

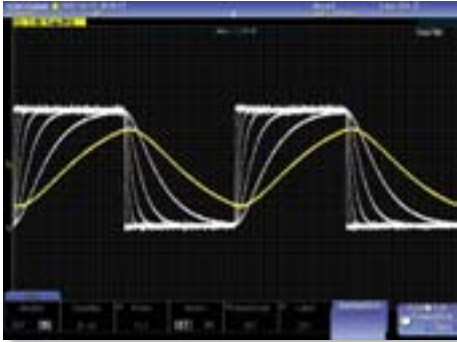

Processing with built-in filters

Computed digital filters

The input waveform can be filtered using an IIR filter, which is a MATH function. Filtered waveforms can be displayed at the same time as the input waveform for comparison. You can select low pass or high pass filters.

Cutoff frequency setting range : 0.01 Hz to 500 MHz



Filtering of a PWM waveform using computation

▶ Zooms into two different points — Waveform zoom and search functions —

Zoom two locations simultaneously

Because the DLM2000 series lets you set zoom factors independently, you can display two zoomed waveforms with different time axis scales at the same time. Also, using the Auto Scroll function, you can automatically scroll waveforms captured in long memory and change the zoomed location. With Auto Scroll you can choose forward, backward, fast-forward, scroll speed, and other control options.

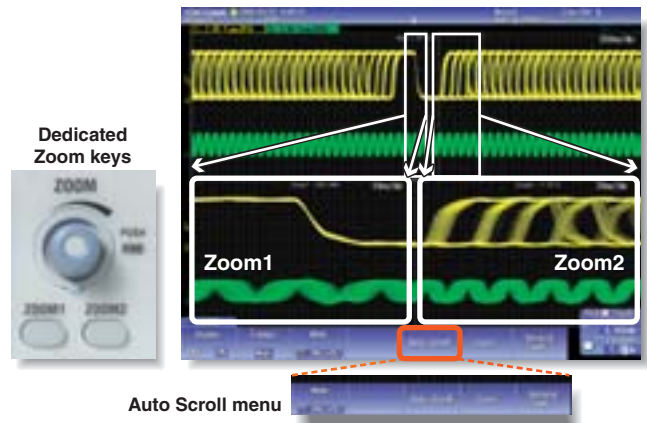

Auto Scroll menu

Large capacity memory gives you a variety of waveform search functions.

Two types of waveform searching:

Normally, searching for data takes time and costs money, and long memory is useless without functions for extracting desired data from a large capacity memory. That's why the DLM2000 series does not simply offer long memory, it also provides powerful waveform search functions.

Searching for data in a single screen: the Zoom Search function

This function searches captured waveforms in the long memory and displays waveforms that meet the search criteria in the zoom area. The locations of the found waveforms are marked on screen (▼ shows the current location).

- **Waveform search criteria**
Edge, edge (with conditions), state pattern, pulse width, state width, serial bus (only on models with the serial bus analysis option)

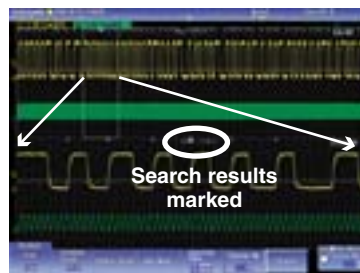

Waveform search using edge criterion

Searching for history waveforms: the History Search function

Criteria can be specified for extracting desired waveforms from up to 20,000 previously captured waveforms.

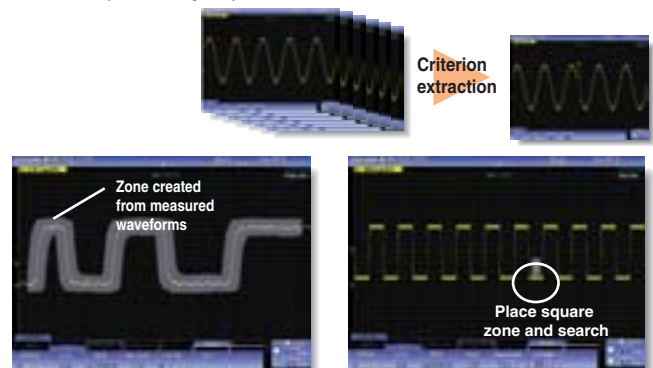

Searching for waveforms in zones created by moving measured waveforms up/down/left/right.

Search for waveforms that pass through/do not pass through a rectangular zone placed on screen.

▶ Displays trends of peak-to-peak or pulse width per cycle

— Measure function and statistics —

Twenty-eight waveform parameters are included such as: maximum, minimum, peak-to-peak, pulse width, period, frequency, rise/fall time, and duty ratio.

Automated measurement can be performed using up to 20 of these waveform parameters. Also, waveform parameters can be measured repeatedly, and the statistical values displayed (mean, maximum, minimum, standard deviation, etc.).



— Trend and histogram displays —

Waveform parameters such as period, pulse width, and amplitude can be measured repeatedly and displayed in graphs. In a single screen you can observe period-by-period fluctuations, compute amplitudes every screen using multiple waveforms, and display amplitudes as trends. You can also display histograms referencing the voltage or time axis using values from repeated automated measurement of waveform parameters.

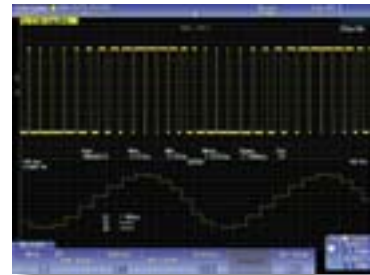

Trend display of waveform parameters
Histogram display using the time axis

▶ Measures voltage/time differences automatically

— Cursor Measurement —

Cursors can be placed on the displayed waveform from signal data, and various measurement values at the intersection of the cursor and waveform can be displayed. There are six types of cursor; ΔT , ΔV , $\Delta T \& \Delta V$, Marker, Degree Cursor.



Simultaneous level and time difference measurement with the $\Delta T \& \Delta V$ cursor

▶ Analyzes frequency spectrums

— FFT analysis —

Up to 2 FFT analyses can be performed simultaneously. FFT can be performed on computed waveforms in addition to the actual waveforms on CH1 to CH4. Analysis can be performed of the frequency components of waveforms filtered for limited bandwidth, of frequency for changes in period of rotary objects, and other phenomena.

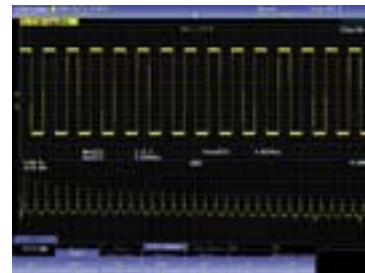

FFT analysis

▶ Keeps waveforms with one push

— Snapshot —

By pressing the SNAPSHOT key to the lower right of the screen, you can freeze a white trace of the currently displayed waveform on the screen. You can press the key repeatedly and conveniently leave traces for comparing multiple waveforms. Also, snapshot data recorded on screen can be saved or loaded as files, and can be recalled for use as reference waveforms when making comparisons.



Using snapshots (white waveforms)

▶ Displays stored files in thumbnail format

— Thumbnails of saved files —

Thumbnails of waveform data, waveform image data, and Wave-Zone files can be displayed. The image and file names are shown so that you can view screen image contents while copying or deleting files. In addition to normal-sized screens, you can even save wide images that have been zoomed along the time axis.



Thumbnails of saved files



Zoomed (2x) long image file

▶ Has a GO/NO-GO function

— Action on trigger —

GO/NO-GO can be determined using trigger conditions, zone waveforms, measurement parameters, and other criteria. For NO-GO, actions can be carried out at the same time such as sounding a buzzer, saving the current waveform, or sending notification to a designated e-mail address. Waveforms in which an abnormality occurred can be saved for confirmation and analysis of the phenomena at a later time.

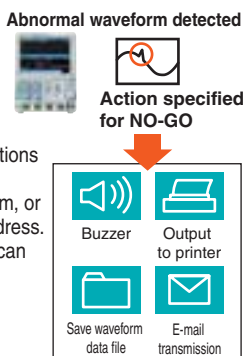

▶ Can check functions with graphical online help

— Graphical online help —

You can view detailed graphical explanations of the oscilloscope's functions by pressing the "?" key in the lower left of the screen. This lets you get help on functions and operations on screen without having to consult the user's manual.



Serial analysis function options (/F1, /F2, /F3, /F4) - UART/CAN/LIN/I²C/SPI-

Triggers for UART, CAN, LIN, I²C, and SPI bus signals are supported along with decode display analysis (serial bus analysis option only on 4 ch models). Logic input can also be used for serial buses (excluding CAN and LIN).

Inputs supported for serial bus analysis

	I ² C	SPI	UART	LIN	CAN
Analog input	Yes	Yes	Yes	Yes	Yes
Logic input	Yes	Yes	Yes	NA	NA

Simultaneous analyses of different busses: Two busses can be analyzed simultaneously. Waveforms and analysis results from busses with different speeds can be displayed in individual Zoom screens with different scales.

A wealth of trigger functions: A wide variety of trigger conditions can be set, such as ID/Data trigger combinations and combinations of serial bus triggers with normal edge triggers.

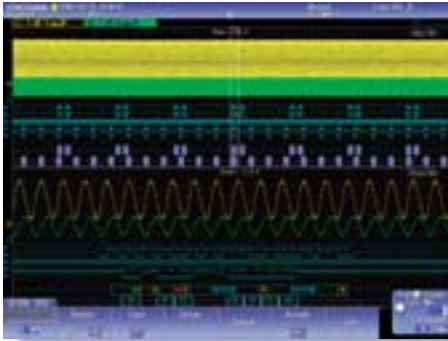

Simultaneous analyses of I²C and SPI



Simultaneous analyses of CAN and LIN

Accessories

PBDH1000 differential probe (model 701924)
1.0 GHz bandwidth
1 MΩ, approximately 1.1 pF
Maximum differential input voltage range: ± 25 V



Differential probe (model 701920)
DC to 500 MHz bandwidth
100 kΩ, approximately 2.5 pF
Maximum differential input voltage range: ±12V



Power supply analysis option (/G4)

Dedicated power supply analysis options are available (4 ch models only) for switching loss, joule integral (i2t), SOA (safe operating area) analysis, harmonic analysis of power supply current based on EN61000-3-2, and other operations.

Switching loss analysis

Voltage and current waveforms can be input to the 62.5 MW (max.) long memory (/M2 models) for computation of switching loss (V(t) X i(t)). A wide variety of switching loss analyses are supported, including turn-on/off loss calculation, loss including continuity loss, and loss over long cycles (50 Hz/60 Hz).

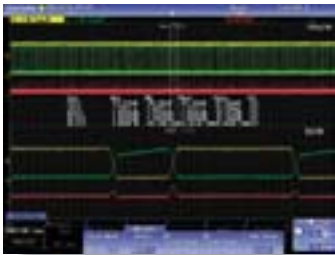

Harmonic analysis of power supply current based on EN61000-3-2

Harmonics determined by the IEC standard that are generated by the target device can be judged for each applicable class (classes A-D). Bar graphs and lists can be displayed for comparing harmonic current limit values with values calculated from actually measured signals.

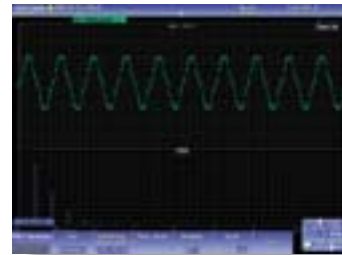

Harmonic current graph display

Related Accessories



700924 Differential probe
DC to 100 MHz
1000 Vrms/ ± 1400 V



701928/701929 Current probe
DC to 100 MHz(701928)
DC to 50 MHz(701929)
30 Arms



701935 Des skew correction signal source

Broad Connectivity and Easier Control

Ethernet (optional)

Supports 1000BASE-T, 100BASE-TX, 10BASE-T

GO/NO-GO I/O terminal

Using the GO/NO-GO function, you can input a timing signal for judging a waveform and output the result as a TTL level signal.

RGB video signal output terminal

You can output an image signal and check the waveform on an external monitor.

USB-PC connection terminal

Enables control from a PC.

USB peripheral connection terminal

Supports USB storage, USB keyboards, USB printers.

Probe power terminal (optional)

Power supply output terminal for current probes (701930 and 701931) and differential probes (701920, 701921, 701922, 700924, 700925, and 701926).

GP-IB connection terminal (optional)

Enables control from a PC.

External trigger input

Lets you input a trigger signal separately from the input signal.

Trigger output

Outputs a CMOS 3.3V level trigger signal.

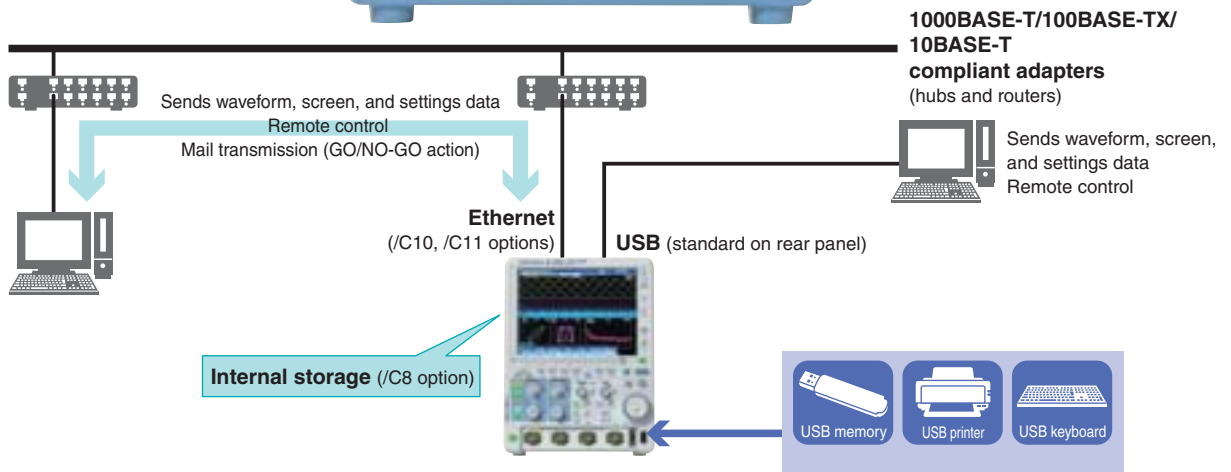

Software

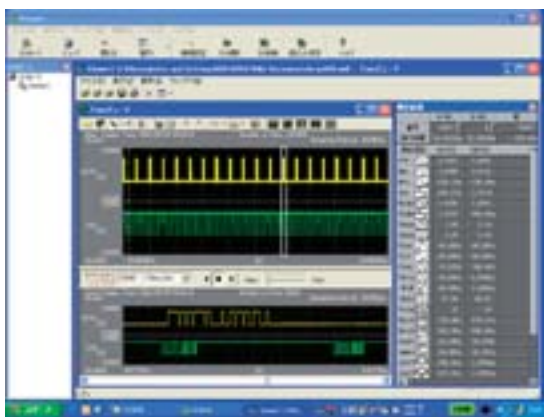

Xviewer (701992, sold separately)

Xviewer is software for use on a PC. It can be used for display, analysis, and conversion to ASCII of binary waveform data using waveforms captured by the DLM2000 series. By adding the MATH option, you can enter user expressions for performing waveform computations. FFT of up to 2 Mwords can be performed.

For details on accessory software, visit

<https://y-link.yokogawa.com/YL000.po>

Also, you can download free software and trial versions of retail software from this site.



DL series library (freeware)

This is an API that enables you to control a DL or send data from a DL using an external program. The API is offered in the form of a DLL that can be called from a program controlled by the user.

Main Specification

Models			
Model name	Frequency bandwidth	Input terminal	Max. sample rate
DLM2022 (710105)	200MHz	2 analog channels	1.25GS/s (interleave mode off)
DLM2032 (710115)	350MHz		
DLM2052 (710125)	500MHz		
DLM2024 (710110)	200MHz	4 analog channels / 3 analog channels + 8bit logic	2.5GS/s (interleave mode on)
DLM2034 (710120)	350MHz		
DLM2054 (710130)	500MHz		

Basic Specifications

Analog Signal Input			
Input channels	Analog input	DLM20x2: CH1, CH2 DLM20x4: CH1 to CH4 (CH1 to CH3 when using logic input)	
Input coupling setting		AC, DC, DC50 Ω, GND	
Input impedance	Analog input	1 MΩ ±1.0%, approximately 20 pF 50 Ω ±1.0% (VSWR 1.4 or less, DC to 500MHz)	
Voltage axis sensitivity setting range	1 MΩ	2 mV/div to 10 V/div (steps of 1-2-5)	
	50 Ω	2 mV/div to 500 mV/div (steps of 1-2-5)	
Max. input voltage	1 MΩ	150 Vrms (CAT I)	
	50 Ω	Must not exceed 5 Vrms or 10 Vpeak	
Max. DC offset setting range	1 MΩ	±1V (2 mV/div to 50 mV/div)	
	50 Ω	±10V (100 mV/div to 500 mV/div) ±100V (1 V/div to 10 V/div) ±1V (2 mV/div to 50 mV/div) ±5V (100 mV/div to 500 mV/div)	
DC accuracy ¹		±(1.5% of 8 div + offset voltage accuracy)	
Offset voltage accuracy ¹	2 mV to 50mV/div	±(1% of setting +0.2 mV)	
	100 mV to 500 mV/div	±(1% of setting + 2 mV)	
	1 V to 10 V/div	±(1% of setting + 20 mV)	
Frequency characteristics (-3 dB attenuation when inputting a sinewave of amplitude ±3div) ¹⁺²		DLM202x	DLM203x DLM205x
1 MΩ (when using passive probe)	100 mV to 100 V/div	DC to 200 MHz	DC to 350 MHz DC to 500 MHz
	20 mV to 50 mV/div	DC to 150 MHz	DC to 300 MHz DC to 400 MHz
50 Ω	10 mV to 10 V/div	DC to 200 MHz	DC to 350 MHz DC to 500 MHz
	2 mV to 5 mV/div	DC to 150 MHz	DC to 300 MHz DC to 400 MHz
Isolation between channels		-34 dB@ analog bandwidth (typical value)	
Residual noise level ³		The larger of 0.4 mV rms or 0.05 div rms (typical value)	
A/D resolution		8bit (25LSB/div) Max. 12 bit (in High Resolution mode)	
Bandwidth limit		FULL, 200 MHz, 100MHz, 20 MHz, 10 MHz, 5 MHz, 2 MHz, 1 MHz, 500 kHz, 250 kHz, 125 kHz, 62.5 kHz, 32 kHz, 16 kHz, 8 kHz (can be set for each channel)	
Maximum sample rate		1.25 GS/s	
Real time sampling mode	Interleave OFF	2.5 GS/s	
	Interleave ON	125 GS/s	
Repetitive sampling mode		Repeat/Single/Single Interleave:	
Maximum record length	2 ch model (Standard)	1.25 M/6.25 M/12.5 MPoints	
	2 ch model (/M1S)	6.25 M/25 M/62.5 MPoints	
	4 ch model (Standard)	Repeat/Single/Single Interleave:	
	4 ch model (/M1)	1.25 M/6.25 M/12.5 MPoints	
	4 ch model (/M1)	Repeat/Single/Single Interleave:	
	4 ch model (/M2)	6.25 M/25 M/62.5 MPoints	
	4 ch model (/M2)	Repeat/Single/Single Interleave:	
		12.5 M/62.5 M/125 MPoints	
Ch-to-Ch deskew		±100 ns	
Time axis setting range		1 ns/div to 500 s/div (steps of 1-2-5)	
Time base accuracy		±0.002%	
Max. acquisition rate ⁴		Approx. 20,000 waveform/sec/ch (Accumulation mode)	
Dead time in N Single mode		Approx. 2.2 μs (approx. 450,000 waveforms/sec/ch)	
Logic Signal Input (4 ch model only)		8 bit (excl. 4 ch input and logic input)	
Number of inputs		Model 701988: 100 MHz	
Maximum toggle frequency ¹		Model 701989: 250 MHz	
Compatible probes		701988, 701989 (8 bit input) (701980, 701981 are available)	
Min. input voltage		701988: 500 mVp-p 701989: 300 mVp-p	
Input range		Model 701988: ±40 V Model 701989: threshold ±6V	
Max. nondestructive input voltage		±40 V (DC + ACpeak) or 28 Vrms (when using 701989)	
Threshold level setting range		Model 701988: ±40 V (setting resolution of 0.05 V) Model 701989: ±6 V (setting resolution of 0.05 V)	
Input impedance		701988: Approx. 1 MΩ/approx. 10 pF 701989: Approx. 100 kΩ/approx. 3 pF	
Maximum sampling rate		1.25 GS/s	
Maximum record length	Standard	Repeat: 1.25 MPoints, Single: 6.25 MPoints	
	/M1, /M1S option	Repeat: 6.25 MPoints, Single: 25 MPoints	
	/M2 option	Repeat: 12.5 MPoints, Single: 62.5 MPoints	

Triggers

Trigger modes	Auto, Auto Level, Normal, Single, N-Single
Trigger type, trigger source	A triggers
	Edge CH1 to CH4, Logic, EXT, LINE
	Edge OR CH1 to CH4
	Edge Qualified CH1 to CH4, Logic, EXT
	State CH1 to CH4, Logic
	Pulse width CH1 to CH4, Logic, EXT
	State width CH1 to CH4, Logic
	TV CH1 to CH4
Serial Bus	
	i°C (optional) CH1 to CH4, Logic
	SPI (optional) CH1 to CH4, Logic
	UART (optional) CH1 to CH4, Logic
	CAN (optional) CH1 to CH4
	LIN (optional) CH1 to CH4
	User defined CH1 to CH4
AB triggers	
A Delay B	10 ns to 10 s (Edge, Edge Qualified, State, Serial Bus)
A to B(N)	1 to 10 ⁹ (Edge, Edge Qualified, State, Serial Bus)
Dual Bus	Serial bus only
	±4 div from center of screen
	0.01 div (TV trigger: 0.1 div)
	±(0.2 div + 10% of trigger level)
	Center/Width can be set on individual Channels from CH1 to CH4
Trigger level setting range	CH1 to CH4
Trigger level setting resolution	CH1 to CH4
Trigger level accuracy	CH1 to CH4
Window Comparator	

Display

Display	8.4-inch TFT color liquid crystal display 1024 x 768 (XGA)
---------	---

Functions

Waveform acquisition modes	Normal, Envelope, Average
High Resolution mode	Max. 12 bit (the resolution of the A/D converter can be improved equivalently by placing a bandwidth limit on the input signal.)
Sampling modes	Real time, interpolation, repetitive sampling
Accumulation	Select OFF, Intensity (waveform frequency by brightness), or Color (waveform frequency by color)
Accumulation time	100 ms to 100 s, Infinite
Roll mode	Enabled at 100 ms/div to 500 s/div (depending on the record length setting)
Zoom function	Two zooming windows can be set independently (Zoom1, Zoom2)
Zoom factor	x2 to 2.5 points/10div (in zoom area)
Scroll	Auto Scroll
Search functions	Edge, Edge Qualified, State, Pulse Width, State Width
	i°C (option), SPI (option), UART (option), CAN (option), LIN (option)
History memory	Max. data
	2,500 (record length 1.25 kPoints, with standard)
	10,000 (record length 1.25 kPoints, with /M1 or /M1S option)
	20,000 (record length 1.25 kPoints, with /M2 option)
History search	Select Rect, WAVE, Polygon, or Parameter mode
Replay function	Automatically displays the history waveforms sequentially
	Specified or average waveforms
Cursor	ΔT, ΔV, ΔT & ΔV, Marker, Degree
Snapshot	Currently displayed waveform can be retained on screen

Computation & Analysis Functions

Parameter measurement	MAX, MIN, P-P, HIGH, LOW, Rms, Mean, Sdev, IntegTY+, IntegTY, +OVER, -OVER, Pulse Count, Edge Count, V1, V2, ΔT, Freq, Period, Avg Freq, Avg Period, Burst, Rise, Fall, +Width, -Width, Duty, Delay
Statistical computation of parameters	Min, Max, Ave, Cnt, Sdev
Statistics modes	Continuous, Cycle, History
Trend/Histogram display of wave parameters	Up to 2 trend or histogram display of specied wave parameters
Computations (MATH)	+ , -, x, Filter (Delay, Moving Avg, IIR Lowpass, IIR Highpass), Integ, Count, user defined math (optional)
Computable no. of traces	2 (Math1, Math2) (1 trace for 2ch model)
Max. computable memory length	Standard model: 6.25 MPoints, /M1, /M2 memory expansion option: 25 MPoints, /M2 expansion option: 62.5 MPoints
Reference function	Up to 2 traces (REF1/REF2) of saved waveform data can be displayed and analyzed
Action ON trigger	Modes All Condition, Zone, Param, Rect, Polygon Buzzer, Print, Save, Mail, GO-NOGO out
Analysis	XY Displays XY1, XY2 and T-Y simultaneously
	Number of points: 1.25k, 12.5k, 125k, 250k
	Window functions: Rectangular, Hanning, Flat-Top
	FFT Types: PS (LS, RS, PSD, CS, TF, CH are available with /G2 option)
Histogram	Displays a histogram of acquired waveforms
User-defined math (/G2 Options)	The following operators can be arbitrarily combined in equations: + , -, x, /, SIN, COS, TAN, ASIN, ACOS, ATAN, INTEG, DIFF, ABS, SQRT, LOG, EXP, LN, BIN, DELAY, P2 (power of 2), PH, DA, MEAN, HLBT, PWHH, PWLL, PWHL, PWXX, FV, DUTYH, DUTYL,

The maximum record length that can be computed is as well as standard math functions
 Propagation time difference correction (deskew):
 The difference in propagation time of voltage and current probe signals can be automatically or manually corrected. Correction range is ± 100 ns (0.01 ns resolution)
 Automated measurement of power supply analysis parameters:
 Power supply analysis parameters can be measured automatically and simultaneously with standard measurement items.
 (Automated measurement of two areas is also possible)
 Waveform computation of power supply analysis parameters:
 Wp, Wp+, Wp-, Abs.Wp., P, P+, P-, Abs.P, Z(Impedance)
 Display of the Area of Voltage-Current Operation:
 Allows for checking whether it is within the ASO(area of safe operation)
 Harmonic analysis:
 Harmonic current emission standard IEC 61000-3-2 edition 2.2(EN61000-3-2 (2000))
 Trend display:

Auxiliary analysis functions
 Analysis result save function

Data search and field jump functions
 Analysis list data can be saved to CSV-format files

LIN Bus Signal Analysis Functions (/F4 Option)	
Applicable bus	LIN Rev.1.3, 2.0
Bit rate	19.2 kbps, 9.6 kbps, 4.8 kbps, 2.4 kbps, 1.2 kbps User defined (an arbitrary bit rate from 1000 bps to 200 kbps with resolution of 100 bps)
LIN bus Trigger modes	Break Synch, ID/DATA, ID OR, and ERROR trigger
Auto setup function	Auto setting of bit rate, threshold value, time axis scale, voltage axis scale, and display of analysis results
Analyzable no. of frames	100,000 frames max.
Analysis results displays	Analysis no., time from trigger position (Time (ms)), ID, ID-Field, Data, CheckSum, information
Auxiliary analysis functions	Data search and field jump functions
Analysis result save function	Analysis list data can be saved to CSV-format files

GP-IB (/C1 & /C11 Options)	
Electromechanical specifications	Conforms to IEEE std. 488-1978 (JIS C 1901-1987)
Protocol	Conforms to IEEE std. 488.2-1987

Auxiliary Input	
Rear panel I/O signal	External trigger input(DLM20x2: front panel), external trigger output, GO-NOGO output, video output
Probe interface terminal (front panel)	4 terminals (DLM20x4)
Probe power terminal (rear panel)	2 terminals (/P2 option) 4 terminals (/P4 option)

Internal Storage (Standard model /C8 Option)	
Capacity	Standard model: 100 MB /C8 option: 1.8 GB

Built-in Printer (/B5 Option)	
Built-in printer	112 mm wide, monochrome, thermal

USB Peripheral Connection Terminal	
Connector	USB type A connector x 2 (front panel x 1, rear panel x 1)
Electromechanical specifications	USB 2.0 compliant
Supported transfer standards	Low Speed, Full Speed, High Speed
Supported devices	USB Printer Class Ver. 1.0 compliant EPSON/HP (PCL) ink jet printers USB Mass Storage Class Ver. 1.1 compliant mass storage devices* Please contact your local Yokogawa sales office for model names of verified devices

USB-PC Connection Terminal	
Connector	USB type B connector x 1
Electromechanical specifications	USB 2.0 compliant
Supported transfer standards	High Speed, Full Speed
Supported class	USBTMC-USB488 (USB Test and Measurement Class Ver. 1.0)

Ethernet (/C10 & /C11 Options)	
Connector	RJ-45 connector x 1
Transmission methods	Ethernet (1000BASE-T/100BASE-TX/10BASE-T)
Supported services	Server: FTP, VXI-11 Client: SMTP, SNMP, LPR, DHCP, DNS

General Specifications	
Rated supply voltage	100 to 240 VAC
Rated supply frequency	50 Hz/60 Hz
Maximum power consumption	170 VA
External dimensions	226 (W) x 293 (H) x 193 (D) mm (when printer cover is closed, excluding protrusions)
Weight	Approx.4.2kg With no options
Operating temperature range	5 °C to 40 °C

*1 Measured under standard operating conditions after a 30-minute warm-up followed by calibration.

Standard operating conditions: Ambient temperature: 23°C \pm 5°C
 Ambient humidity: 55 \pm 10% RH

Error in supply voltage and frequency: Within 1% of rating

*2 Value in the case of repetitive phenomenon. The frequency bandwidth of a single-shot phenomenon is the smaller of the two values, DC to sampling frequency/2.5 or the frequency bandwidth of the repetitive phenomenon.

*3. When the input section is shorted, the acquisition mode is set to Normal, accumulation is OFF, and the probe attenuation is set to 1:1.

*4. Acquisition rate does not vary with an increase or decrease in channels.

External Dimensions

Unit: mm

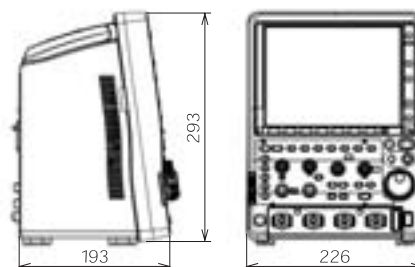

I ² C Bus Signal Analysis Functions (/F2 & /F3 Options)		
Applicable bus	I ² C bus	Bus transfer rate: 3.4 Mbit/s max. Address mode: 7 bit/10 bit
	SM bus	Complies with System Management Bus
I ² C Trigger modes		Every Start, Address & Data, Non-Ack, General Call, Start Byte, HS Mode
Analyzable signals		Assignable to CH1 to CH4, Logic input, or M1 to M2
Analysis results displays		Analysis no., time from trigger position (Time (ms)), 1st byte address, 2nd byte address, R/W, Data, Presence/absence of ACK, information
Auto setup function		Auto setting of bit rate, threshold value, time axis scale, voltage axis scale, and display of analysis results
Analyzable no. of data		300,000 bytes max.
Search function		Searches data that matches specified address pattern, data pattern, and acknowledge bit condition
Analysis results save function		Analysis list data can be saved to CSV-format files

SPI Bus Signal Analysis Functions (/F2 & /F3 Options)		
Trigger types	3 wire/4 wire	After assertion of CS, compares data after arbitrary byte count and triggers.
Byte order		MSB/LSB
Auto setup function		Auto setting of bit rate, threshold value, time axis scale, voltage axis scale, and display of analysis results
Analyzable no. of data		300,000 bytes max.
Decode bit length		Specify data interval (1 to 32 bits), decode start point, and data length
Analysis results displays		Analysis no., time from trigger position (Time (ms)), Data 1, Data 2
Auxiliary analysis functions		Data search function
Analysis result save function		Analysis list data can be saved to CSV-format files

UART Bus Signal Analysis Functions (/F1 & /F3 Options)		
Bit rate	1200 bps, 2400 bps, 4800 bps, 9600 bps, 19200 bps, user defined (an arbitrary bit rate from 1 k to 1 Mbps with resolution of 100 bps)	
Data format		Select a data format from the following 8 bit (Non Parity) / 7 bit Data + Parity / 8 bit + Parity
UART Trigger modes		Every Data, Data, Error (Framing, Parity)
Analyzable signals		Select CH1 to CH4, logic input, or M1 to M2
Auto setup function		Auto setting of bit rate, threshold value, time axis scale, voltage axis scale, and display of analysis results
Analyzable no. of frames		300,000 frames max.
Analysis results displays		Analysis no., time from trigger position (Time(ms)), Data (Bin, Hex) display, ASCII display, and Information.
Auxiliary analysis functions		Data search
Analysis result save function		Analysis list data can be saved to CSV-format files

CAN Bus Signal Analysis Functions (/F4 Option)		
Applicable bus		CAN version 2.0A/B, Hi-Speed CAN (ISO11898), Low-Speed CAN (ISO11519-2)
Bit rate		1 Mbps/500 kbps/250 kbps/125 kbps/83.3 kbps/33.3 kbps User defined (an arbitrary bit rate from 10.0 kbps to 1.000 Mbps with resolution of 100 bps)
CAN bus Trigger modes		SOF, ID/DATA, ID OR, Error(enabled when loading physical values/symbol definitions)
Auto setup function		Auto setting of bit rate, threshold value, time axis scale, voltage axis scale, and display of analysis results
Analyzable no. of frames		100,000 frames max.
Analysis results displays		Analysis no., time from trigger position (Time (ms)), Frame type, ID, DLC, Data, CRC, presence/absence of Ack, information

Model and Suffix Codes

Model	Suffix code	Description
710105		Digital Oscilloscope DLM2022 2ch, 200MHz
710110 ¹		Mixed Signal Oscilloscope DLM2024 4ch, 200MHz
710115		Digital Oscilloscope DLM2032 2ch, 350MHz
710120 ¹		Mixed Signal Oscilloscope DLM2034 4ch, 350MHz
710125		Digital Oscilloscope DLM2052 2ch, 500MHz
710130 ¹		Mixed Signal Oscilloscope DLM2054 4ch, 500MHz
Power cable	-D	UL/CSA standard
	-F	VDE standard
	-Q	BS standard
	-R	AS standard
	-H	GB standard
Help language	-HE	English Help (Menu and Panel)
	-HC	Chinese Help (Menu and Panel)
	-HK	Korean Help (Menu and Panel)
	-HG	German Help (Menu and Panel)
	-HF	French Help (Menu and Panel)
	-HI	Italian Help (Menu and Panel)
	-HS	Spanish Help (Menu and Panel)
Option	/LN	No switchable logic input (4 ch model only)
	/B5	Built-in printer
		"Memory expansion option (4 ch model only) During continuous measurement: 6.25 Mpoints; Single mode: 25 Mpoints (when interleave mode ON: 62.5 Mpoints)"
	/M1 ²	
		"Memory expansion option (4 ch model only) During continuous measurement: 12.5 Mpoints; Single mode: 62.5 Mpoints (when interleave mode ON: 125 Mpoints)"
	/M2 ²	
		"Memory expansion option (2 ch model only) During continuous measurement: 6.25 Mpoints; Single mode: 25 Mpoints (when interleave mode ON: 62.5 Mpoints)"
	/M1S	
		"Memory expansion option (2 ch model only) During continuous measurement: 6.25 Mpoints; Single mode: 25 Mpoints (when interleave mode ON: 62.5 Mpoints)"
	/P2 ³	Probe power for 2 ch models
	/P4 ³	Probe power for 4 ch models
	/C1 ⁴	GP-IB Interface
	/C10 ⁴	Ethernet Interface
	/C11 ⁴	GP-IB + Ethernet Interface
	/C8	Internal storage (1.8 GB)
/G2 ⁵	User defined math (4 ch model only)	
/G4 ⁵	"Power supply analysis function (includes /G2) (4 ch model only)"	
/F1 ⁶	UART trigger and analysis (4 ch model only)	
/F2 ⁶	I ² C + SPI trigger and analysis (4 ch model only)	
/F3 ⁶	UART + I ² C + SPI trigger and analysis (4 ch model only)	
/F4	CAN + LIN trigger and analysis (4 ch model only)	

- *1: Logic probes sold separately. Please order the model 701988/701989 accessory logic probes separately.
 *2: Only one of these may be selected at a time.
 *3: Specify this option when using current probes or other differential probes such as models 701920 or 701922.
 *4: Only one of these may be selected at a time.
 *5: Only one of these may be selected at a time.
 *6: Only one of these may be selected at a time.

[DLM is a pending trademark or registered trademark of Yokogawa Electric Corporation.]
 Any company's names and product names appearing in this document are the registered trademarks or trademarks of their respective companies.

NOTE



"Before operating the product, read the user's manual thoroughly for proper and safe operation."

Yokogawa's Approach to Preserving the Global Environment

- Yokogawa's electrical products are developed and produced in facilities that have received ISO14001 approval.
- In order to protect the global environment, Yokogawa's electrical products are designed in accordance with Yokogawa's Environmentally Friendly Product Design Guidelines and Product Design Assessment Criteria.

YOKOGAWA

YOKOGAWA CORPORATION OF AMERICA
 2 Dart Road, Newnan, Georgia 30265-1094, U.S.A.
 Phone: (1)-770-253-7000, Fax: (1)-770-251-6427

YOKOGAWA EUROPE B.V.
 Euroweg 2, 3825 HD, Amersfoort, THE NETHERLANDS
 Phone: (31)-88-4641000, Fax: (31)-88-4641111

YOKOGAWA ENGINEERING ASIA PTE. LTD.
 5 Bedok South Road, Singapore 469270
 Phone: (65)-62419933, Fax: (65)-62412606

YOKOGAWA MEASURING INSTRUMENTS KOREA CORP.
 Phone: (82)-2-551-0660, Fax: (82)-2-551-0665

YOKOGAWA SHANGHAI TRADING CO., LTD.
 Phone: (86)-21-5405-0303, Fax: (86)-21-6880-9254

YOKOGAWA ELECTRIC CORPORATION
 Communication & Measurement Business Headquarters
 2-9-32 Nakacho, Musashino-shi, Tokyo, 180-8750 Japan
 Phone: (81)-422-52-6768, Fax: (81)-422-52-6624
 E-mail: tm@cs.jp.yokogawa.com

Standard Main Unit Accessories

Part Name	Quantity
Power cord (with 3-prong to 2-prong adapter)	1
*Passive probe, model 701938 (200 MHz, 1.5 m) For models 710105, 710110 ¹	Per number of channels
*Passive probe, model 701939 (500 MHz, 1.3 m) For models 710115, 710120, 710125, 710130 ¹	Per number of channels
Protective front cover	1
Soft carrying case for probes	1
Printer roll paper (for /B5 option)	1 roll
User's manuals	1 set

Accessory Models

Name	Model	Specification
Logic probe (PBL100)	701988	1 MΩ input resistance, toggle frequency of 100 MHz
Logic probe (PBL250)	701989	100 kΩ input resistance, toggle frequency of 250 MHz
Passive probe	701938	10 MΩ (10:1), 200 MHz, 1.5 m
Passive probe	701939	10 MΩ (10:1), 500 MHz, 1.3 m
FET Pprobe	700939	DC to 900 MHz bandwidth/2.5MΩ/1.8pF
Active probe (PBA1000)	701912	DC to 1 GHz bandwidth/100kΩ/0.9pF
100:1 voltage probe	701944	DC to 400 MHz, 1.2 m, 1000 Vrms
100:1 voltage probe	701945	DC to 250 MHz, 3 m, 1000 Vrms
Differential probe	701921	DC to 100 MHz bandwidth/max. ±700 V
Differential probe	701922	DC to 200 MHz bandwidth/max. ±20 V
Differential probe (PBDH1000)	701924	DC to 1 GHz bandwidth/1MΩ/max. ±25 V
Differential probe	700924	DC to 100 MHz bandwidth/max. ±1400 V
Differential probe	700925	DC to 15 MHz bandwidth/max. ±500 V
Differential probe	701920	DC to 500 MHz bandwidth/max. ±12 V
Current probe (PBC050)	701929	DC to 50 MHz bandwidth, 30 Arms
Current probe (PBC100)	701928	DC to 100 MHz bandwidth, 30 Arms
Current probe	701930	DC to 10 MHz bandwidth, 150 Arms
Current probe	701931	DC to 2 MHz bandwidth, 500 Arms
Mini clip converter	700971	For models 701938 and 701939
BNC adapter	700972	For models 701938 and 701939
PCB adapter	366945	For models 701938 and 701939, 10 per set
Solder-in adapter	366946	For models 701938 and 701939, 1 adapter, red/black cables (3 ea.)
Printer roll paper	B9988AE	Lot size is 10 rolls, 10 meters each
Xviewer	701992-SP01	For DL/WE series, standard version
	701992-GP01	For DL/WE series, with MATH functions
Probe stand	701919	Round base, 1 arm
Carrying case	701964	Also for DL1600/DL1700E series

<http://www.DLM2000.net/>

Mixed Signal Oscilloscope

DLM 2000 Series

Special Site



Product demonstration (Flash) now available
 Check here for updated firmware information.
 Manual download service! *

* Check here for oscilloscope accessories.

Represented by :



S J ELECTRONICS
 POWER • TEST & MEASUREMENT

0800 583 44 55

Tel: +44 1536 416 200

Fax: 0800 583 55 66

sales@sjelectronics.co.uk

www.sjelectronics.co.uk