



# Introduction to Video Measurements

## Using an MDO/MSO/DPO Series Digital Phosphor Oscilloscope

### Application Note

#### Introduction

Whether you're troubleshooting a video installation or designing a new set top box, making video measurements can be a major challenge. Video waveforms are complex and frequently combine the signals that represent the video picture with the timing information necessary to display the picture. The signals can be in a variety of different standards and formats, each with its own characteristics. Some video measurements require specialized instruments, such as industry-standard Tektronix waveform monitors, video

measurement sets and vectorscopes. Many, however, can be made quickly and easily with a general-purpose oscilloscope - providing that the instrument has the right acquisition and measurement capabilities.

In this application note, we will examine critical video measurement issues and show how they relate to the capabilities of different kinds of oscilloscopes. We will also demonstrate how to make common video measurements using an MDO/MSO/DPO Series - MSO/DPO5000, MDO4000 and MDO3000 Series - digital phosphor oscilloscope.

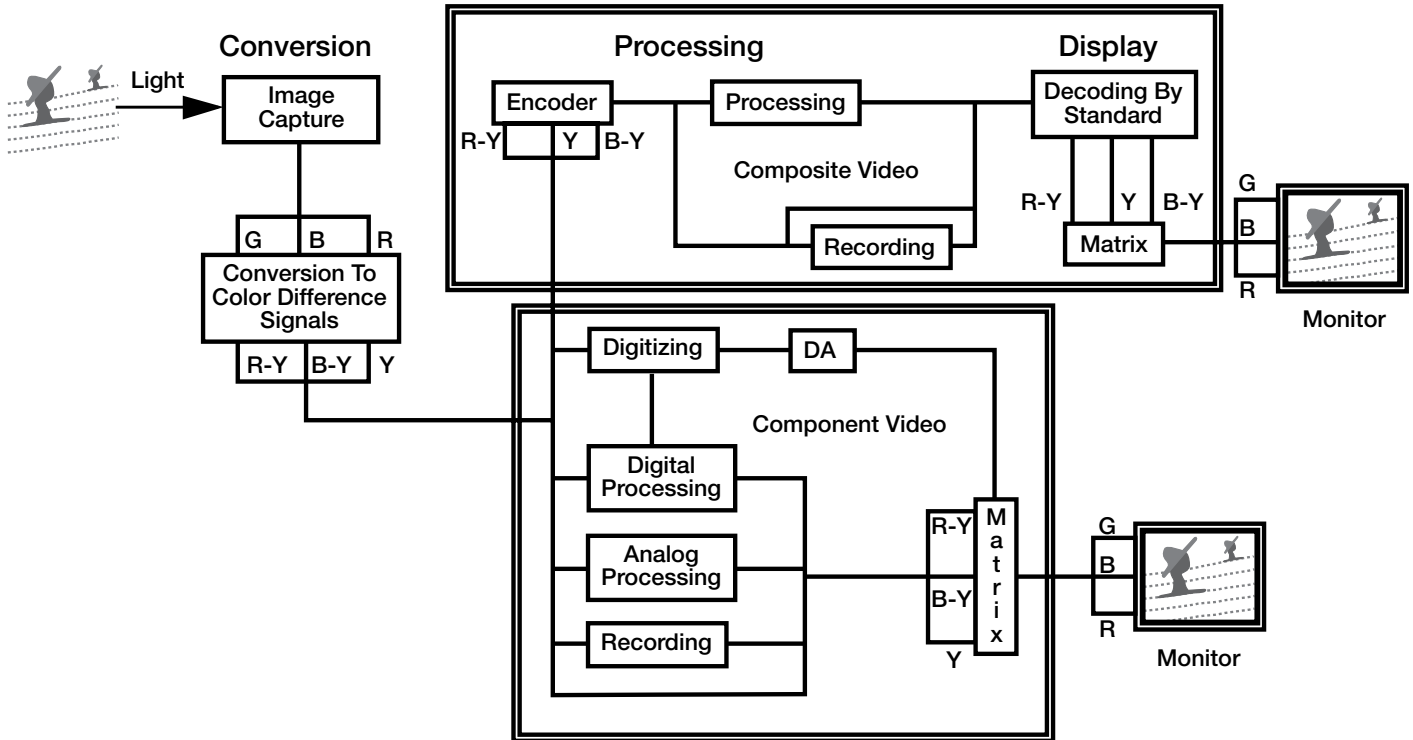


Figure 1. Typical block diagram of a standard definition video system.

## Basic Video Standards and Formats

There are many different video standards and formats. Some systems, such as NTSC, PAL and SECAM, have been in use for decades and are commonly referred to as “standard definition” television. Newer systems, such as High Definition Television (HDTV), offer higher resolution by increasing the number of lines and pixels within the picture. Video signals can originate from many sources, including cameras, scanners, and graphics terminals. Signals that have not been modulated on an RF carrier for transmission are called baseband video signals. These include most video signals used in analog terrestrial or cable transmission systems. Typically, baseband video signals begin as three component analog or digital signals representing the three primary color elements – the Red, Green, and Blue (RGB) components. These signals often go through many transformations before they reach the television monitor.

Figure 1 shows a typical video system block diagram. The steps will be similar whether the system is standard or high definition. Notice that the video signal changes formats several times between its source and its destination. To design and debug such systems, test equipment must be able to examine signals in each of the formats.

### Conversion

The first format change occurs in the very first step, conversion. To make processing easier, the original RGB signal is usually converted into three component signals: the Luma signal or Y, and two color difference signals derived from Y, usually B-Y and R-Y.

The color-difference signals may be modified, depending on the standard or format used. For SMPTE analog component systems, for example, they are scaled to become Pb and Pr. In NTSC composite systems, the color-difference signals are scaled to I and Q. For PAL systems they become U and V, and so forth. Once converted, the three component signals can be distributed for processing.

## Processing

The controls we tweak on television monitors simply change how the image is displayed. In video processing, the video signals are edited, mixed or otherwise altered and prepared for transmission and viewing. The video component signals can be combined to form a single composite video signal (as in NTSC, PAL, or SECAM systems). They can be maintained separately as discrete component signals (as in RGB graphics and HDTV systems). They can be divided into separate luminance and chrominance signals (as in Y/C systems, such as in S-VHS or Hi-8). They may even be upconverted to HDTV signals.

## Composite Video

Composite video signals are most common in traditional broadcast and cable TV applications. They are called “composite” because they contain multiple signal components combined into a single signal. In North America and Japan the NTSC standard defines the way that Luma (black and white information), chrominance (color information), and synchronization (timing information) are encoded into the composite video signal. In most other countries, the PAL and SECAM standards provide the same function. In these standards, the chrominance signals are modulated on a pair of color subcarriers. The modulated chrominance signal is then added to the luminance signal to form the active portion of the video signal. Finally, the synchronization information is added. Although complex, this composite signal has the advantage of being carried on a single coaxial cable.

## Component Video

Component video signals, however, are preferred within television studios. They are simpler to generate, record, and process where many combinations of switching, mixing, special effects, color correction, noise reduction, and other functions may be applied to the signals. Since there is no encoding/decoding process, as in composite video, it is easier to maintain signal integrity in component video systems and equipment. This results in a higher quality image. The drawback to component video is that the signals must be carried on separate cables. This limits the distances over which the signals can be transmitted and requires careful matching of signal paths.

## Y/C Video

Y/C video is a compromise solution used in S-VHS and Betacam systems. Y/C is a component format that modulates the chrominance signals on a pair of color subcarriers, but keeps the chrominance signal separate from the luminance signal. This minimizes the luminance/chrominance artifacts of composite systems while simplifying the inter-channel timing issues of component systems. Y/C signals can be carried on a single special cable.

## High Definition Television

The baseband signal can be processed into (or even originate as) high definition television signals. Obviously, upconverted standard definition signals cannot have the same quality and resolution as native high definition signals. We will take a closer look at HDTV a little later.

## Display

After transmission, the objective of the display step is to accurately reproduce the processed image. In composite systems, the signal has to be decoded to component form and then translated to RGB format for display on the monitor. Component video signals go through less processing since they can be converted directly to an RGB signal for display.

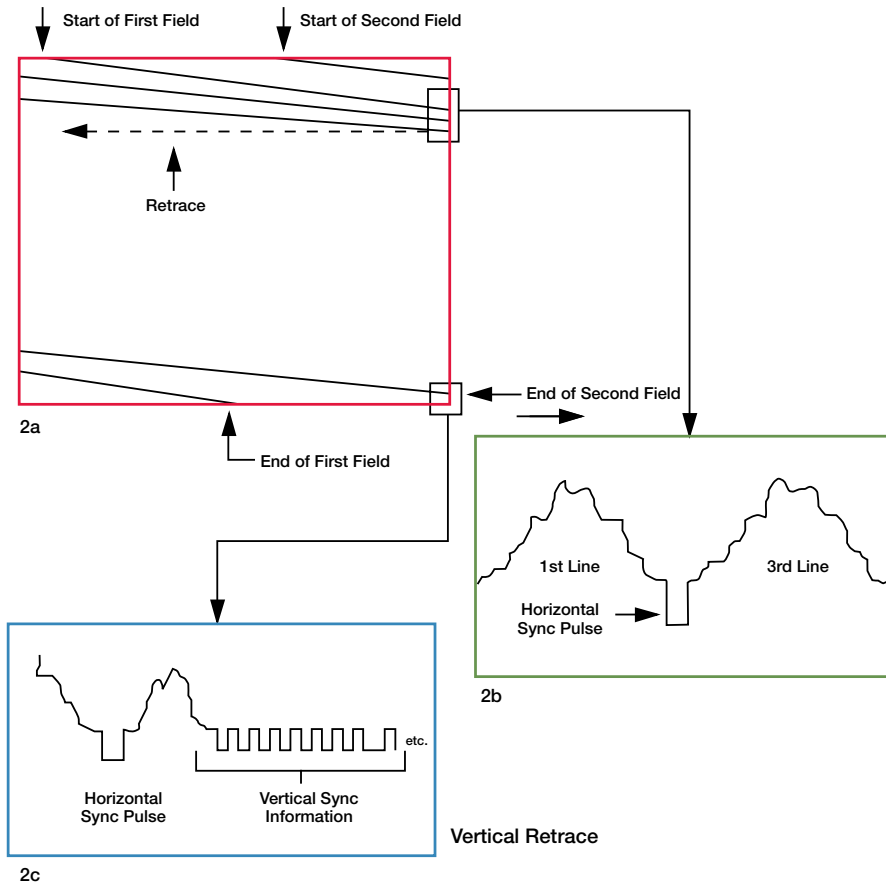
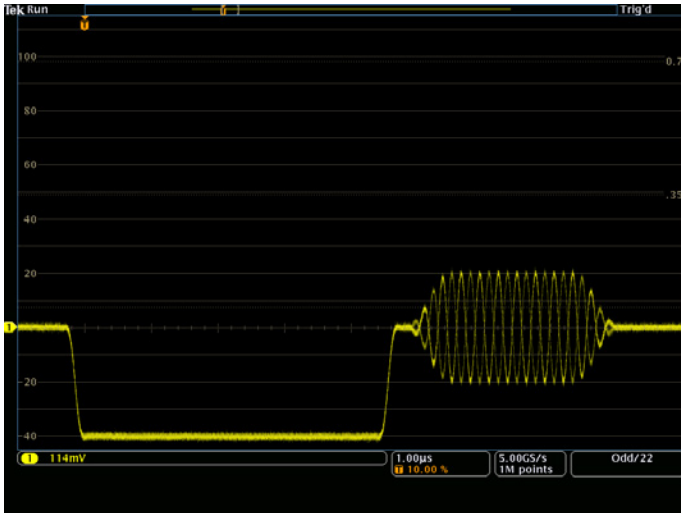


Figure 2a, 2b, and 2c. The synchronization signals in an analog composite baseband.

## Video Synchronization

To reproduce an image, both the camera and the video display are scanned horizontally and vertically (see Figure 2a). The horizontal lines on the screen might be scanned alternately – odd numbered lines first, then even numbered lines – as in interlaced scanning systems, or they might be scanned sequentially as in progressive scanning systems.

Both the camera and display must be synchronized to scan the same part of the image at the same time. This synchronization is handled by the horizontal sync pulse, which is part of the baseband video signal. The horizontal sync pulse starts a horizontal trace. During the horizontal blanking interval, the beam returns to the left side of the screen and waits for the horizontal sync pulse before tracing another line. This is called “horizontal retrace” (see Figure 2b).



**Figure 3a.** The horizontal blanking portion of an NTSC baseband video waveform.

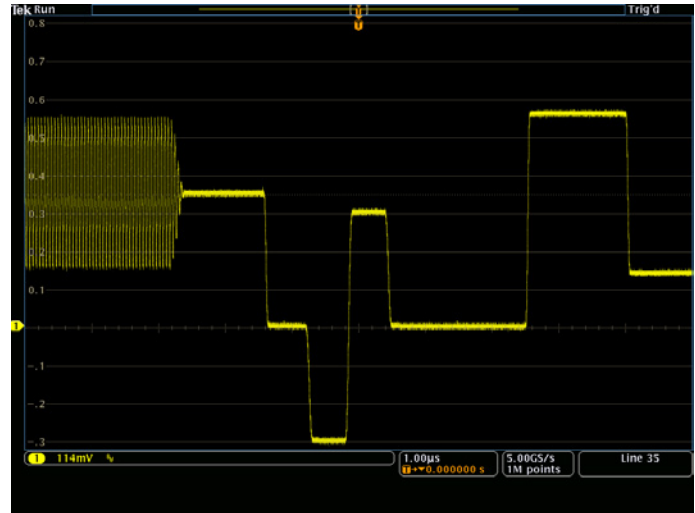
When the beam reaches the bottom of the screen, it must return to the top to begin the next field or frame. This is called the “vertical retrace” and is signaled by the vertical sync pulse (see Figure 2c). The vertical retrace takes much longer than the horizontal retrace, so a longer synchronizing interval – the “vertical blanking interval” – is employed. No information is written on the video screen during the horizontal or vertical blanking intervals.

Each video standard defines a series of synchronization signals that control how the video signal is displayed. PAL signals display a video frame 25 times a second and a frame contains 625 video lines. NTSC signals display a video frame 30 times a second, but with only 525 lines. Some high-resolution computer monitors display more than 1000 lines with a frame rate of 72 times a second.

Component signals need timing signals too. The synchronization is often combined with one of the components (such as the green channel).

## HDTV

So far, we have concentrated on classic standard definition systems such as NTSC and PAL. High Definition Television offers higher resolution by increasing the number of lines and pixels within the picture. There are numerous



**Figure 3b.** An HDTV baseband video waveform showing a tri-level synchronization pulse.

HDTV standards. These standards are referred to by their characteristics. The first part states the number of active lines present in the signal. The second part specifies whether the picture is interlaced (i) progressive (p), or a combination referred to as segmented frame (sF). The final part refers to the field (for interlaced signals) or frame rate (for progressive signals) of the format, which defines the number of pictures displayed in one second.

## HDTV Synchronization

A standard definition signal uses a bi-level synchronization signal that allows circuits to lock to the line and field rate of the television signal. Figure 3a shows the horizontal blanking portion of an NTSC baseband video signal with its bi-level horizontal sync pulse.

In HDTV, however, a tri-level sync signal is used as shown in Figure 3b. The pulse contains three levels –300mv, 0mv and +300mv with a timing interval dependent on the clock rate of the appropriate HDTV format. The timing and voltage cursors of the MDO/MSO/DPO Series - MSO/DPO5000, MDO4000, and MDO3000 Series - make it easy to measure these parameters.

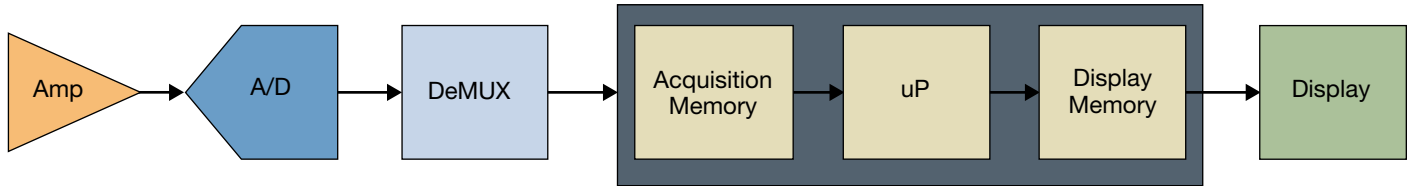


Figure 4. Serial-processing architecture of a digital storage oscilloscope (DSO).

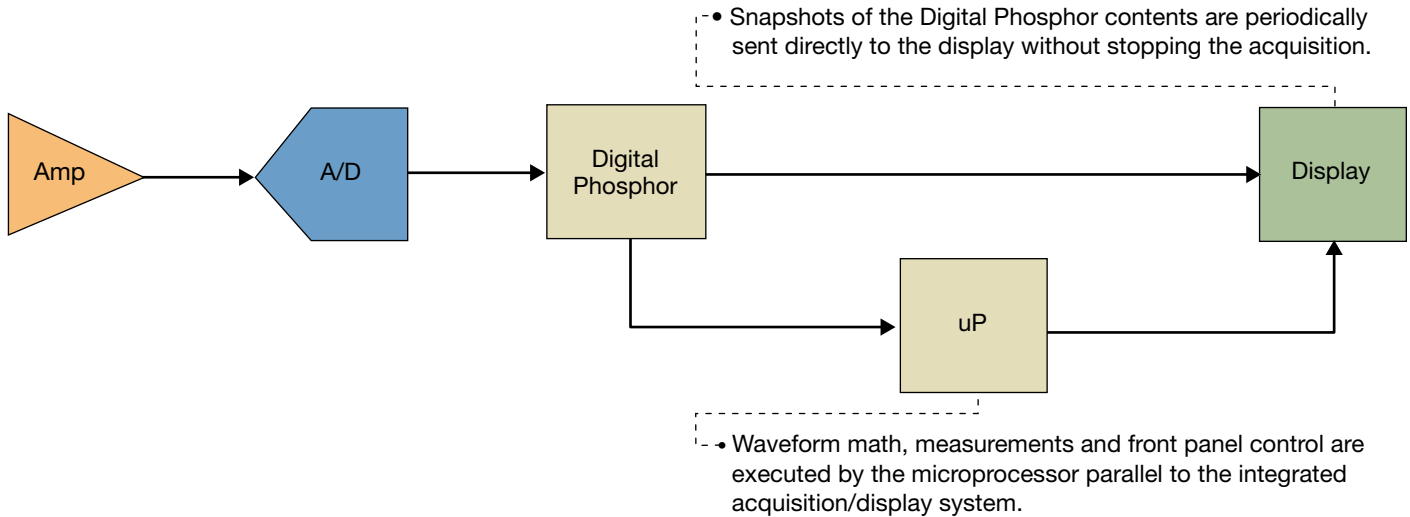


Figure 5. Parallel-processing architecture of a digital phosphor oscilloscope(DPO).

## Test Setup Requirements

Before we look at how to measure video signals, let's consider what measurement tools will serve us best to efficiently test a variety of applications.

### Choosing the Right Oscilloscope

Oscilloscopes are universal test instruments. They create two dimensional representations of the signal that allow us to “see” the waveform in the time domain. Not all oscilloscopes are created alike, however, and some are better suited for video applications than others.

### Analog Versus Digital Storage

In the past, designers and engineers had to choose between two types of oscilloscopes, analog real-time and digital storage (DSO). Since each had distinct advantages, many users tried to keep both types at hand.

Analog oscilloscopes provide fast capture rates and intensity-graded displays to bring a real-time “statistical” dimension to the waveform. Varying brightness levels clearly show the frequency of occurrence of different parts of the signal. Experienced users can quickly characterize the quality of the signal, spot anomalies, and get real-time feedback as they adjust their systems.

Digital storage oscilloscopes have their own advantages. DSOs offer automated measurements, sophisticated triggering, waveform storage, and hard copy capabilities that analog instruments cannot. DSOs, however, also have drawbacks. DSOs rely on a serial-processing architecture that requires microprocessor intervention in every step of the signal acquisition process (see Figure 4). DSO capture rates are too slow to accurately portray complex video signals and they lack the intensity-graded information so necessary for troubleshooting.

## The Digital Phosphor Alternative

There is a third choice. Digital phosphor oscilloscopes (DPOs) combine the best of analog and digital storage oscilloscopes. DPOs offer all the traditional benefits of a DSO, from data storage to sophisticated triggers. In addition, they capture and display waveform information in three dimensions—amplitude, time, and distribution of amplitude over time—much like an analog oscilloscope. DPOs digitally emulate the chemical phosphorescence process that creates the intensity-grading in an analog oscilloscope's CRT.

The result is a live-time display that duplicates the feature-rich nature of the signal. DPOs provide unmatched insight into subtle patterns of behavior and dynamic characteristics of video signals. The power of a DPO lies in its parallel-processing architecture (see Figure 5). The DPO rasterizes the digitized waveform data into a database called the digital phosphor. At the frame rate of the display, a snapshot of the signal image stored in the digital phosphor is sent directly to the display system. Meanwhile waveform math, measurements, and front panel control are executed by the microprocessor in parallel to the integrated acquisition/display system. This direct rasterization of waveform data, and direct copy-to-display memory, removes the bottleneck in data processing common to DSOs.

Some advanced DPOs feature a DPX™ waveform imaging processor that greatly increases the scope's waveform capture rate. This proprietary ASIC enables the MDO/MSO/DPO Series to provide maximum waveform capture rates as fast as 280,000 waveforms per second on the MDO3000 Series, >250,000 waveforms per second on the MSO/DPO5000 Series, and >270,000 waveforms for per second on the MDO4000 Series. This fast waveform capture rate gives users maximum insight into signal activity. They gain a higher probability of witnessing transient problems such as runt pulses, glitches and transition errors. Some DSOs do provide a special mode that alternates between bursting

multiple captures into long memory and following up with a display cycle. This can temporarily deliver rates of about 20,000 - 40,000 waveforms per second, but with substantial dead-time while the waveform data is processed and displayed. These performance levels do not compare to the unprecedented live-time afforded by DPOs.

Analog oscilloscopes share the characteristics of fast waveform captures rates and intensity-graded displays with DPOs. Analog oscilloscopes, unfortunately, lack many basic features offered by DSOs and DPOs, such as automatic measurements, advanced triggering, waveform math, and waveform storage. In effect, DPOs combine the strengths of analog and DSO architectures, while avoiding their weaknesses.

## Basic Oscilloscope Specifications

In addition to their architecture, oscilloscopes can also be described by their specifications. The first is usually **bandwidth**. A good rule of thumb is to use an oscilloscope with an analog bandwidth at least five times the bandwidth of the signal to ensure accurate representation of the signal. (A way to estimate the bandwidth of your signal is to divide the number 0.35 by the 10 to 90% risetime of the fastest signal component.) The bandwidth of an HDTV signal, for example, is typically 30 MHz. Therefore, an oscilloscope for HDTV applications should have bandwidth of at least 150 MHz. MDO/MSO/DPO Series oscilloscopes offer bandwidths up to 2 GHz.

The **sample rate** dictates how fast the signal is sampled. For accurate reconstruction using  $\sin(x)/x$  interpolation, your oscilloscope should have a sample rate at least 2.5 to 5 times the highest frequency component of your signal. If you are using linear interpolation, the sample rate should be at least 10 times the highest frequency signal component. MDO/MSO/DPO Series oscilloscopes use  $\sin(x)/x$  interpolation and sample up to 10 GS/s, accurately representing even the most complex video standards.

Video Format	Number of Active Lines	Number of Active Pixels Per Line	Progressive, Interlaced, or Segmented	Frame/Field Rate	Total Number of Lines	MDO3000 MSO/DPO5000 Series	MDO4000 Series
525i/NTSC	480	N/A	i	60	525	Standard	Standard
625i/PAL	576	N/A	i	50	625		
625i/SECAM	576	N/A	i	50	625		
480p/60	480	720	p	60	525		Optional with DPO4VID, HDTV and Custom Video Triggering Module
576p/50	576	720	p	50	625		
720p/30	720	1280	p	30	750		
720p/50	720	1280	p	50	750		
720p/60	720	1280	p	60	750		
875i/60	809	N/A	i	60	875		
1080i/50	1080	1920	i	50	1125		
1080i/60	1080	1920	i	60	1125		
1080p/24	1080	1920	p	24	1125		
1080p/24sF	1080	1920	sF	48	1125		
1080p/25	1080	1920	p	25	1125		
1080p/30	1080	1920	p	30	1125		
1080p/50	1080	1920	p	50	1125		
1080p/60	1080	1920	p	60	1125		

**Table 1.** Video standards supported by the MDO/MSO/DPO Series.

An oscilloscope's **waveform capture rate** specifies the rate at which signals are acquired (in waveforms/second). As we mentioned, most traditional DSOs capture signals at a much lower rate than analog oscilloscopes or DPOs. Slower rates can hide signal anomalies and cast doubt on your analysis. The MDO/MSO/DPO Series features maximum waveform capture rates as fast as 280,000 waveforms per second on the MDO3000 Series, >250,000 waveforms per second on the MSO/DPO5000 Series, and as fast as 340,000 waveforms for per second on the MDO4000 Series, to enable a lively, information rich display of your video signal.

The **record length** of a digital oscilloscope, expressed as the number of points that comprise a complete waveform

record, determines the amount of data that can be captured with each channel. Since an oscilloscope can store only a limited number of samples, the waveform duration (time) will be inversely proportional to the oscilloscope's sample rate. Oscilloscopes with short record lengths force you to make a trade-off between signal detail and record length, or between sample rate and time duration acquired. You can acquire either a detailed picture of a signal for a short period of time or a less detailed picture for a longer period of time. Fortunately, the MDO/MSO/DPO Series comes standard with up to 25 M point record lengths on all channels (varies by Series), allowing you to capture long periods of signal activity without sacrificing signal detail.





**Figure 6.** The 4000 Series' video trigger allows convenient selection of video standard, source, component to trigger on, polarity, and holdoff settings. In this example, the oscilloscope has triggered on line 39 of the Odd Field of an NTSC signal.

## Key Oscilloscope Features for Video

### Intensity graded display

As we discussed, the most critical display issue for many video engineers is to have an intensity-graded display. This familiar characteristic of analog oscilloscopes and waveform monitors shows the signal's statistical behavior by varying the intensities of the displayed samples. MDO/MSO/DPO Series digital phosphor oscilloscopes provide this intensity-graded display. The insight they give through qualitative intensity information enables users to visually assimilate subtle details and variations of the signal.

### Video Triggers

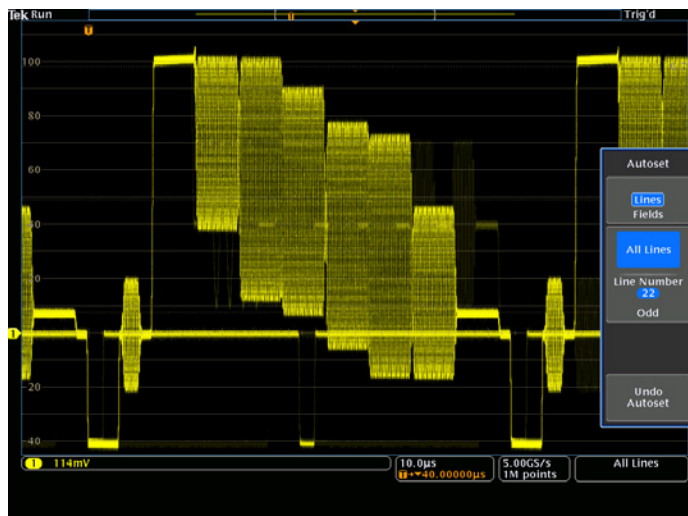
The first step in analyzing video waveforms is getting a stable display. Before you can capture and analyze a signal, you must first trigger the oscilloscope on the signal. Each of the MDO/MSO/DPO Series comes standard with video triggers for NTSC, PAL, and SECAM standards, making this job much easier.

The optional DPO4VID application module (for MDO4000 Series) modules adds support for a variety of analog HDTV standards. These HDTV video triggers come standard with MSO/DPO5000 Series and the MDO3000 Series. HDTV formats are identified by the number of active lines, the type of scan, and the frame or field rate. Table 1 summarizes the standard and optional video formats supported by the MDO/MSO/DPO Series.

Once the video format is selected, the next step is to specify exactly what to trigger on. The MDO/MSO/DPO Series offers a variety of choices including Even Fields, Odd Fields, All Fields, All Lines, or Line Number as shown in Figure 6.

### Custom Video Trigger

Not every video system conforms to NTSC, PAL, SECAM or HDTV formats. As a rule, computer video monitors, medical displays, security cameras, and other self-contained systems are not designed to interface directly with broadcast video equipment and may not adhere to the normal 525- or 625-line standards. The MDO/MSO/DPO Series offers an easy solution for these applications with its custom video triggering capabilities. The custom video trigger requires a couple of easily measured input parameters so it knows what to look for. To measure these parameters, start with Edge triggering mode and run the trigger level down until you're triggering on the negative sync pulse of the video signal. Adjust the scope's vertical and horizontal controls to get a good view of the sync pulse. The first thing to specify for the scope is whether the video signal uses a bi-level sync pulse or tri-level sync pulse (see Figures 3a and 3b). If it's bi-level, use cursors to measure the width of the sync pulse. Next, increase the time/div setting until the sync pulses for two lines of video are both on the oscilloscope display and again using cursors, measure the time between the sync pulses. Last, specify whether the video signal is progressive or interlaced. Once these few simple parameters are specified, the MDO/MSO/DPO Series can trigger on Even Fields, Odd Fields, All Fields, All Lines, or Line Number (4-3000) on custom (non-standard) video signals.



**Figure 7.** The 4000 Series' Autoset feature makes setting up the oscilloscope for video as simple as a single button press.

## Video Autoset

Many oscilloscope users have become accustomed to using the front panel Autoset button to have the scope automatically adjust vertical, horizontal, and edge trigger parameters for a usable display for a variety of signals. Unfortunately, these Autoset functions have not typically worked on complex video signals in the past. However, the MDO4000 and MDO3000 Series Autoset recognizes video signals and sets up the oscilloscope for optimal viewing. For example, simply connecting a 1080i/60 HDTV color bar signal to channel 1 and pressing Autoset results in the display shown in Figure 7. Notice that the Autoset function also brings up a side menu allowing quick selection of triggering on lines vs. fields, etc.

## Video Graticules

Another usability feature highlighted in Figure 7 is video graticules. Autoset automatically activates an IRE graticule for NTSC signals and an mV graticule for all other video signals. In addition, it automatically sets the vertical scale to 114mV/div to scale the signal appropriately for the graticule. Anytime the trigger type is set to video, the 114mV/div vertical scale setting is inserted into the regular 1-2-5 sequence for each of the analog channels, making it easy to scale the video signal so it covers the whole display for easiest viewing and maximum accuracy.

## Cursors

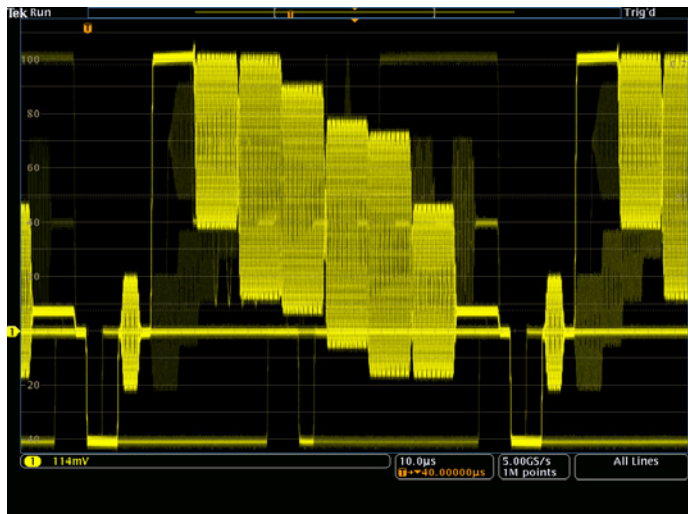
Cursors make manual on-screen measurements faster and more accurate. Horizontal cursors allow you to measure signal amplitudes while Vertical cursors make it easier to measure signal timing. Amplitude readouts are even shown in IRE when the trigger type is set to NTSC.

## Signal Conditioning

### Termination

Most video systems are designed to deliver a known amplitude signal into a specified impedance. Improper termination can degrade frequency response, so video measurement accuracy depends on terminating the signal

into a precise resistance, usually 75 Ohms. At lower frequencies, a simple 75 Ohm feed-through termination can be used (part number 011-0055-xx). At higher frequencies, the termination must match the impedance of the transmission line (usually coaxial cable). The termination impedance must have a precise resistance with negligible reactance (also known as maximizing the return loss and minimizing the voltage standing wave ratio). A 75 ohm BNC connector that provides precision termination for higher frequency video applications is needed. The MDO3000 Series (<1 GHz models) is unique in that it provides built-in 75 Ohm input termination - thus no external termination is required.



**Figure 8.** A familiar video line rate display of signal amplitude vs. time on a digital phosphor oscilloscope illustrating the waveform monitor-like appearance of its intensity-graded display.

## Common Video Signal Measurements

### Basic Monitoring

When you are monitoring analog video signals, an oscilloscope with an intensity-graded display can be your most valuable debug tool. Subtle variations in the signal, which are not visible on a DSO display, can spell the difference between a video system that works and one that doesn't.

### Line Rate Intensity-graded Displays of Live Video

The most basic analog video display is that of line signal amplitude vs. time. This display is easily accomplished by triggering on the leading edge of sync using an All Lines trigger mode.

A digital phosphor oscilloscope with an intensity-graded display (and a waveform capture rate high enough to capture every line) provides a familiar line rate display similar to a waveform monitor (see Figure 8).

### Amplitude Measurements

The concept of unity gain through a system has been fundamental since the beginning of television. Standardization of video amplitude lets us design each system element for optimum signal-to-noise performance and freely interchange signals and signal paths. When setting analog video amplitudes, it is not sufficient to simply adjust the output level of the final piece of equipment in the signal path. Every piece of equipment should be adjusted to appropriately transfer the signal from input to output. In digital formats, maintenance of video amplitude is even more important. Adequate analog video amplitude into the system assures that an optimum number of quantization levels are used in the digitizing process to reproduce a satisfactory picture. Maintaining minimum and maximum amplitude excursions within limits assures the video voltage amplitude will not be outside the range of the digitizer. Aside from maintaining correct color balance, contrast, and brightness, video amplitude must be controlled within gamut limits legal for transmission and valid for conversion to other video formats.

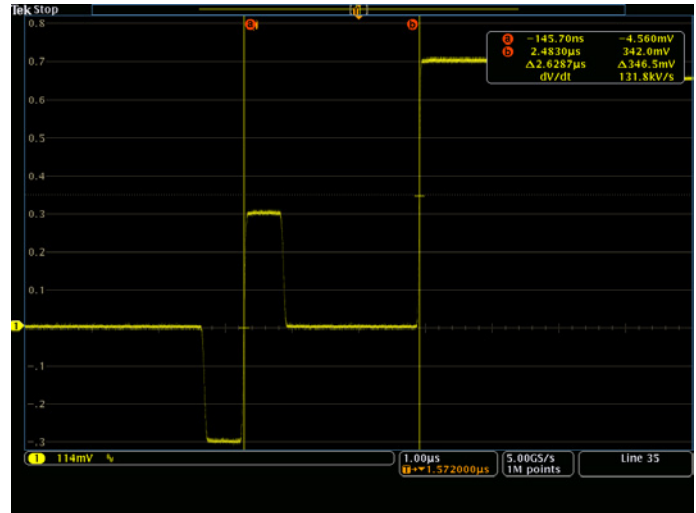


**Figure 9.** An example of amplitude measurements on an NTSC signal. The peak-to-peak amplitude of the color burst is measured with the oscilloscope's peak-to-peak measurement. The area of the waveform the measurement is being taken on is gated by the cursors.

Amplitude measurements can be made a number of ways with an oscilloscope. The easiest method is to simply compare the signal to the IRE or mV video graticule for an approximate measurement. Next, you could use the oscilloscope's horizontal cursors to make a more precise measurement. Finally, you could use the oscilloscope's suite of automatic measurements along with cursor gating to analyze variations over time by accumulating measurement statistics. Figures 9 and 10 show examples of common amplitude measurements on both standard definition and high definition video signals.

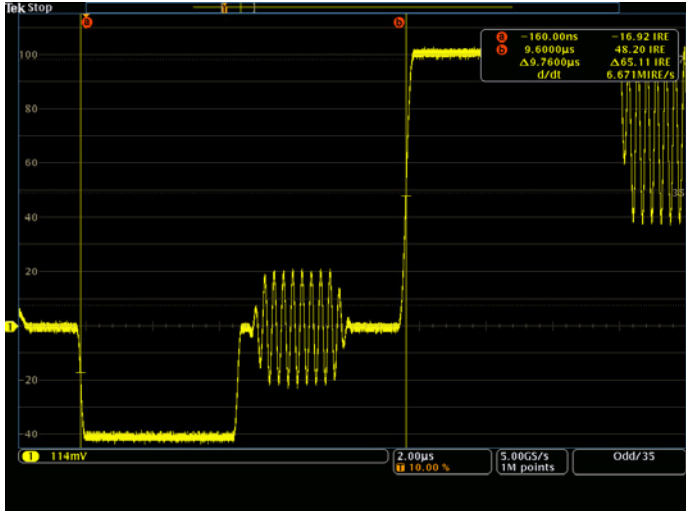
## Timing Measurements

Timing and synchronization are critical in ensuring compatibility of the video output signal with other devices. The horizontal and vertical video sync signals are expected

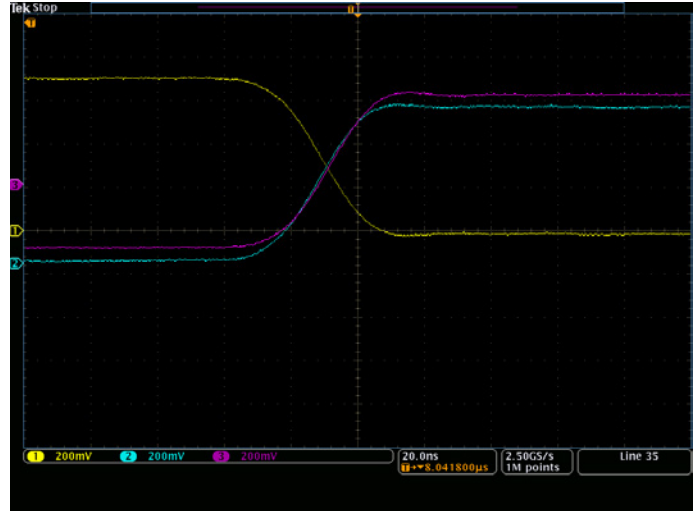


**Figure 10.** Using cursors to measure the Y signal white level amplitude and the time from 0H to the start of active video in a 1080i/60 HDTV 100% color bar signal.

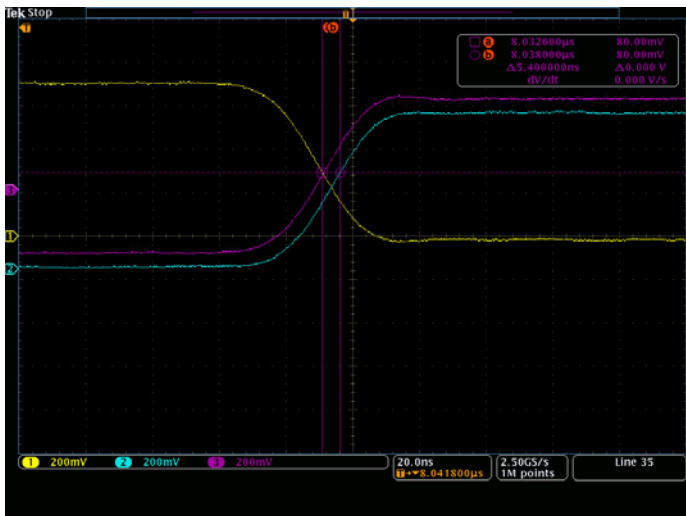
to occur at regular intervals and at specific times within the video signal. Incorrect placement of these pulses can lead to the output of the device not being correctly locked to another device and can cause disturbances in the image or a completely unlocked image and a rolling or unsynchronized picture. Therefore, it is important to ensure the synchronizing signals of the output device conform within specification and tolerances of the appropriate video standard. For example, the active picture should occur within a specific start time and end time to ensure that image is correctly centered within the display. Failure to conform to the standard timing results in the first part of the image not being displayed if active video begins too soon, while the last part of the image may get cropped if active video ends too late.



**Figure 11.** Measuring the horizontal blanking interval from sync to start of active video on an NTSC color bar signal.



**Figure 12a.** Correct timing of the luminance (Y) and the color-difference signals (Pb and Pr) during the green to magenta transition of a 100% color bar signal.



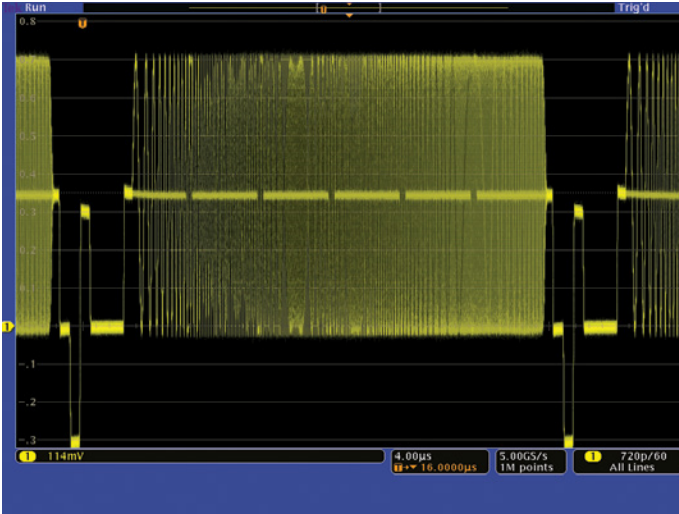
**Figure 12b.** Measuring the delay in the Pb signal due to an additional length of cable or processing time.

Timing measurements are made in a similar fashion to amplitude measurements. Again, the easiest approach is to make a visual comparison with the graticule. For more precise measurements, use cursors or the oscilloscope's suite of automatic measurements. Figure 11 illustrates measuring the horizontal blanking interval on an NTSC signal.

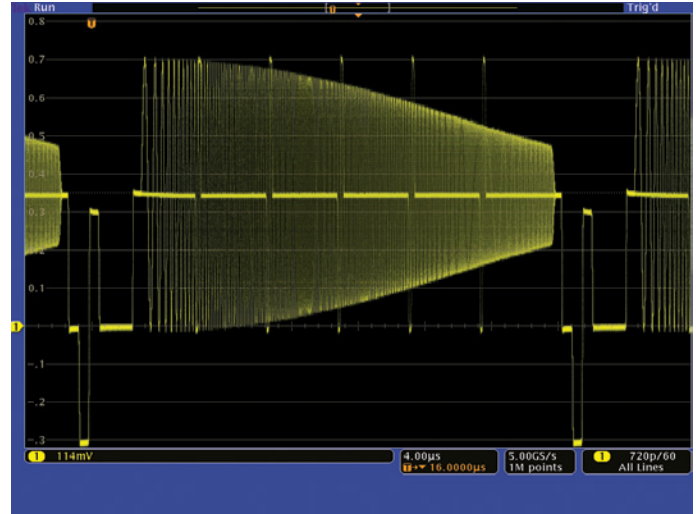
In component video, the signal paths carrying each signal should be identical as different lengths of cable or different processing times for each channel can lead to interchannel timing errors. These errors typically result in fringing effects or a Luma-Chroma shift in the image.

This is illustrated in Figures 12a and 12b where we're using a color bar test signal and measuring the transition time between channels at the green-magenta transition. This transition is of particular interest because it has the the greatest voltage change between the color bar levels. In Figure 12a, all channels are crossing together as desired. However, in Figure 12b, we see that the Pb signal has a delay in it possibly due to either additional cable length or processing time.





**Figure 13a.** Line sweep of an analog HDTV signal with no frequency roll off—a pure signal.



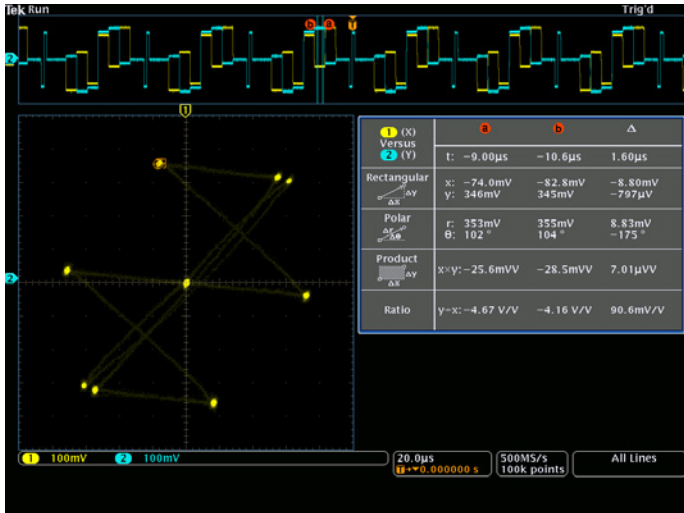
**Figure 13b.** Effects of a roll off above 20 MHz.

## Video Frequency Response

In an analog video system, video frequency response will be equalized where necessary to compensate loss of high-frequency video information in long cable runs. The goal is to make each stage of the system “flat” so all video frequencies travel through the system with no gain or loss. In a digital system, high-frequency loss affects only the energy in the transport data stream (the transport layer), not the data numbers (the data layer) so there is no effect on video detail or color until the high-frequency loss is so great the data numbers cannot be recovered.

To test frequency response, apply a sweep test signal to your system. This produces a sweep from 1-30 MHz across the line of the signal. Ideally, you should observe a flat response at the output of the system as in Figure 13a. If frequencies in the sweep signal are not the same amplitude at the output stage as in Figure 13b, an equalizing video distribution amplifier may be used to compensate, restoring the sweep test signal to its original value. By performing amplitude measurements at the maximum and minimum amplitude of the signal, the frequency response distortion can be calculated using the following formula –

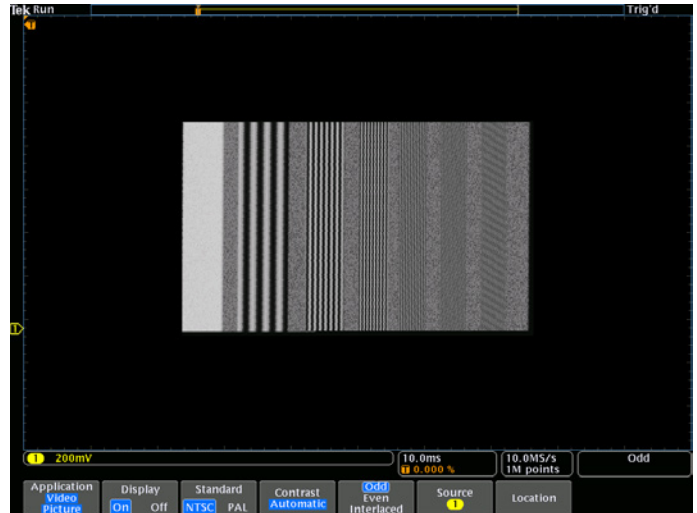
$$20 \log_{10} \frac{I_{\text{Min}}}{I_{\text{Max}}} = \text{Frequency Response Distortion}$$



**Figure 14.** The 4000 Series' XY mode used to view a vectorscope-like display of chroma component signals. Screen cursors with polar readouts indicate the magnitude and phase of the red vector.

### XY Displays of Chrominance

The oscilloscope's XY display mode allows you to display one signal against another in a manner similar to a vectorscope. For example, connecting a B-Y signal to Channel 1 and an R-Y signal to Channel 2 while in XY display mode results in a radial display much like a vectorscope's display. The advantage to using a DPO is that its intensity-graded display shows details in the signal that are not visible on ordinary DSOs.



**Figure 15.** Video picture display of an NTSC multiburst signal.

### Picture Mode Display

The MDO4000 and MDO3000 Series contain picture mode display, providing quick identification of analog NTSC and PAL signals with a monochrome representation of the video content. Video picture mode contains automatic contrast and brightness settings as well as manual controls.



## Conclusion

In this application note, we demonstrated the use of an MDO/MSO/DPO Series - MSO/DPO5000, MDO4000 and MDO3000 Series - digital phosphor oscilloscope to make a variety of video measurements that are common in standard and high definition systems. We illustrated how important an intensity-graded display, high waveform capture rate, and modern digital oscilloscope features can be to making those measurements. These capabilities make the MDO/MSO/DPO Series the tool of choice to debug, characterize, and verify video circuits and systems.

To see the entire Tektronix portfolio of video solutions visit the website at: [www.tektronix.com/video](http://www.tektronix.com/video)

**Contact Tektronix:**

**ASEAN / Australasia** (65) 6356 3900  
**Austria** 00800 2255 4835  
**Balkans, Israel, South Africa and other ISE Countries** +41 52 675 3777  
**Belgium** 00800 2255 4835  
**Brazil** +55 (11) 3759 7627  
**Canada** 1 800 833 9200  
**Central East Europe and the Baltics** +41 52 675 3777  
**Central Europe & Greece** +41 52 675 3777  
**Denmark** +45 80 88 1401  
**Finland** +41 52 675 3777  
**France** 00800 2255 4835  
**Germany** 00800 2255 4835  
**Hong Kong** 400 820 5835  
**India** 000 800 650 1835  
**Italy** 00800 2255 4835  
**Japan** 81 (3) 6714 3010  
**Luxembourg** +41 52 675 3777  
**Mexico, Central/South America & Caribbean** 52 (55) 56 04 50 90  
**Middle East, Asia, and North Africa** +41 52 675 3777  
**The Netherlands** 00800 2255 4835  
**Norway** 800 16098  
**People's Republic of China** 400 820 5835  
**Poland** +41 52 675 3777  
**Portugal** 80 08 12370  
**Republic of Korea** 001 800 8255 2835  
**Russia & CIS** +7 (495) 6647564  
**South Africa** +41 52 675 3777  
**Spain** 00800 2255 4835  
**Sweden** 00800 2255 4835  
**Switzerland** 00800 2255 4835  
**Taiwan** 886 (2) 2656 6688  
**United Kingdom & Ireland** 00800 2255 4835  
**USA** 1 800 833 9200

Rev. 0415

**For Further Information**

Tektronix maintains a comprehensive, constantly expanding collection of application notes, technical briefs and other resources to help engineers working on the cutting edge of technology. Please visit [www.tektronix.com](http://www.tektronix.com) and [www.keithley.com](http://www.keithley.com).

**Copyright © 2015, Tektronix.** All rights reserved. Tektronix products are covered by U.S. and foreign patents, issued and pending. Information in this publication supersedes that in all previously published material. Specification and price change privileges reserved. TEKTRONIX and TEK are registered trademarks of Tektronix, Inc. All other trade names referenced are the service marks, trademarks or registered trademarks of their respective companies.

11/15 EA/WWW

3GW-20975-3

