



S J ELECTRONICS
POWER • TEST & MEASUREMENT



0800 583 4455



sales@sjelectronics.co.uk

VISIT 
WEBSITE

AC Power Source

APS-7000E Series

USER MANUAL

GW INSTEK PART NO. 82PS-7KE00MA1



ISO-9001 CERTIFIED MANUFACTURER

GW INSTEK

This manual contains proprietary information, which is protected by copyright. All rights are reserved. No part of this manual may be photocopied, reproduced or translated to another language without prior written consent of Good Will company.

The information in this manual was correct at the time of printing. However, Good Will continues to improve products and reserves the rights to change specification, equipment, and maintenance procedures at any time without notice.

Good Will Instrument Co., Ltd.
No. 7-1, Jhongsing Rd., Tucheng Dist., New Taipei City 236, Taiwan.

Table of Contents

SAFETY INSTRUCTIONS	4
GETTING STARTED	8
APS-7000E Series Overview	9
Appearance	12
OPERATION	18
Set Up	20
Basic Operation	36
Preset Settings	53
Test Mode Function	57
FAQ	67
APPENDIX	68
Firmware Update	68
APS-7000E Default Settings	70
APS-7000E Specifications	71
APS-7000E Dimensions	74
Declaration of Conformity	76
INDEX	77

S SAFETY INSTRUCTIONS

This chapter contains important safety instructions that you must follow during operation and storage. Read the following before any operation to ensure your safety and to keep the instrument in the best possible condition.

Safety Symbols

These safety symbols may appear in this manual or on the instrument.



Warning: Identifies conditions or practices that could result in injury or loss of life.



Caution: Identifies conditions or practices that could result in damage to the APS-7000E or to other properties.



DANGER High Voltage



Attention Refer to the Manual



Protective Conductor Terminal



Earth (ground) Terminal



Do not dispose electronic equipment as unsorted municipal waste. Please use a separate collection facility or contact the supplier from which this instrument was purchased.

Safety Guidelines

General Guideline



CAUTION

- Do not place any heavy object on the APS-7000E.
- Avoid severe impact or rough handling that leads to damaging the APS-7000E.
- Do not discharge static electricity to the APS-7000E.
- Use only mating connectors, not bare wires, for the terminals.
- Do not block the cooling fan opening.
- Do not disassemble the APS-7000E unless you are qualified.

(Measurement categories) EN 61010-1:2010 specifies the measurement categories and their requirements as follows. The APS-7000E doesn't fall under category II, III or IV.

- Measurement category IV is for measurement performed at the source of low-voltage installation.
- Measurement category III is for measurement performed in the building installation.
- Measurement category II is for measurement performed on the circuits directly connected to the low voltage installation.
- 0 is for measurements performed on circuits not directly connected to Mains.

Power Supply



WARNING

- AC Input voltage range: 115/230 Vac \pm 15%
 - Frequency: 50/60Hz
 - To avoid electrical shock connect the protective grounding conductor of the AC power cord to an earth ground.
-

- Cleaning the APS-7000E
- Disconnect the power cord before cleaning.
 - Use a soft cloth dampened in a solution of mild detergent and water. Do not spray any liquid.
 - Do not use chemicals containing harsh material such as benzene, toluene, xylene, and acetone.
-

Operation Environment

- Location: Indoor, no direct sunlight, dust free, almost non-conductive pollution (Note below)
- Relative Humidity: 20%~ 80%, no condensation
- Altitude: < 2000m
- Temperature: 0°C to 40°C

(Pollution Degree) EN 61010-1:2010 specifies the pollution degrees and their requirements as follows. The APS-7000E falls under degree 2.

Pollution refers to “addition of foreign matter, solid, liquid, or gaseous (ionized gases), that may produce a reduction of dielectric strength or surface resistivity”.

- Pollution degree 1: No pollution or only dry, non-conductive pollution occurs. The pollution has no influence.
 - Pollution degree 2: Normally only non-conductive pollution occurs. Occasionally, however, a temporary conductivity caused by condensation must be expected.
 - Pollution degree 3: Conductive pollution occurs, or dry, non-conductive pollution occurs which becomes conductive due to condensation which is expected. In such conditions, equipment is normally protected against exposure to direct sunlight, precipitation, and full wind pressure, but neither temperature nor humidity is controlled.
-

Storage environment

- Location: Indoor
 - Temperature: -10°C to 70°C
 - Relative Humidity: $\leq 80\%$, no condensation
-

Disposal



Do not dispose this instrument as unsorted municipal waste. Please use a separate collection facility or contact the supplier from which this instrument was purchased. Please make sure discarded electrical waste is properly recycled to reduce environmental impact.

Power cord for the United Kingdom

When using the instrument in the United Kingdom, make sure the power cord meets the following safety instructions.

NOTE: This lead/appliance must only be wired by competent persons



WARNING: THIS APPLIANCE MUST BE EARTHED

IMPORTANT: The wires in this lead are coloured in accordance with the following code:

Green/ Yellow:	Earth
Blue:	Neutral
Brown:	Live (Phase)



As the colours of the wires in main leads may not correspond with the coloured marking identified in your plug/appliance, proceed as follows:

The wire which is coloured Green & Yellow must be connected to the Earth terminal marked with either the letter E, the earth symbol  or coloured Green/Green & Yellow.

The wire which is coloured Blue must be connected to the terminal which is marked with the letter N or coloured Blue or Black.

The wire which is coloured Brown must be connected to the terminal marked with the letter L or P or coloured Brown or Red.

If in doubt, consult the instructions provided with the equipment or contact the supplier.

This cable/appliance should be protected by a suitably rated and approved HBC mains fuse: refer to the rating information on the equipment and/or user instructions for details. As a guide, a cable of 0.75mm² should be protected by a 3A or 5A fuse. Larger conductors would normally require 13A types, depending on the connection method used.

Any exposed wiring from a cable, plug or connection that is engaged in a live socket is extremely hazardous. If a cable or plug is deemed hazardous, turn off the mains power and remove the cable, any fuses and fuse assemblies. All hazardous wiring must be immediately destroyed and replaced in accordance to the above standard.

GETTING STARTED

This chapter describes the power source in a nutshell, including its main features and front / rear panel introduction.



APS-7000E Series Overview	9
Series lineup	9
Operating Area	9
Main Features	10
Accessories	11
Appearance	12
Front Panel	12
Rear Panel	15

APS-7000E Series Overview

Series lineup

The APS-7000E series consists of 2 models, the APS-7050E and the APS-7100E, differing only in capacity. Note that throughout the user manual, the term “APS-7000E” refers to both the APS-7050E and APS-7100E, unless stated otherwise.

Model name	Max. Output Current	Power Rating	Output Voltage
APS-7050E	4.2A/2.1A	500VA	0~310.0 Vrms
APS-7100E	8.4A/4.2A	1000VA	0~310.0 Vrms

Operating Area

APS-7050E Output Operating Area

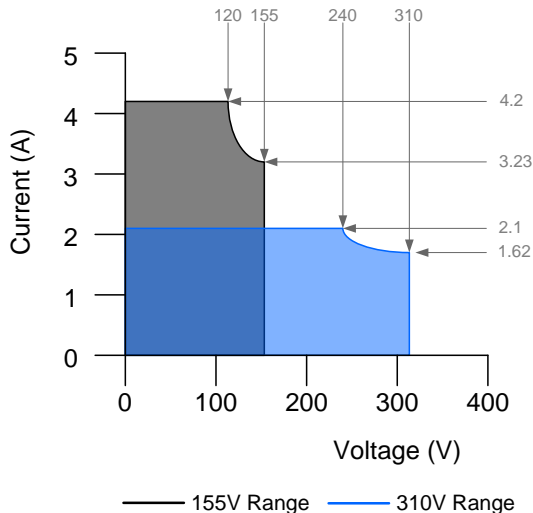

APS-7100E Output Operating Area

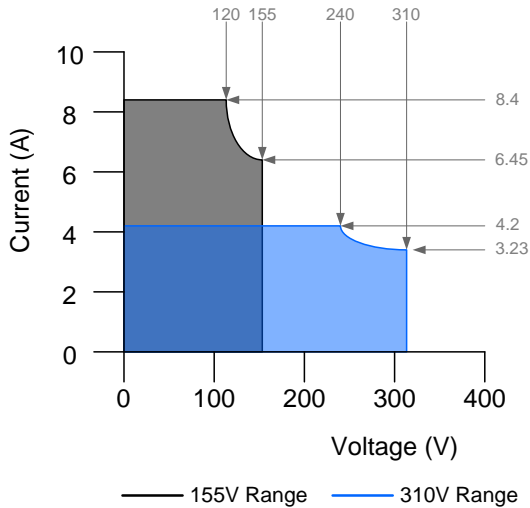

Main Features

Performance

- Low output ripple and noise
- Excellent and feature-rich measurement capacity
- Standard maximum output voltage is 310Vrms
- Maximum frequency of 500Hz.

- Features
- OVP, OCP and OTP protection
 - Variable voltage, frequency and current limiter
 - Test function to simulate line voltage and frequency variations
 - Large 4.3 inch TFT panel
 - Globally adjustable power inlet not restricted by the power supply environment
 - USB interface is equipped as standard with the ability to upgrade the software.
 - Only 88mm (2U) case height.
-

- Interface
- USB host

Accessories

Standard Accessories	Part number	Description
	CD ROM	User manual
	Region dependent	Type I Power cord (APS-7050E)
	Region dependent	Type II Power cord (APS-7100E)
	62PS-7K0SC701 x1 5302-01613001 x1	Mains terminal cover set (APS-7050E)
	62PS-7K0SC401 x1 5302-01613001 x2	Mains terminal cover set (APS-7100E)
	GTL-123	Test leads: 1x red, 1x black
Optional Accessories	Part number	Description
	GRA-423	APS-7000E rack mount kit

Appearance

Front Panel

APS-7050E, APS-7100E

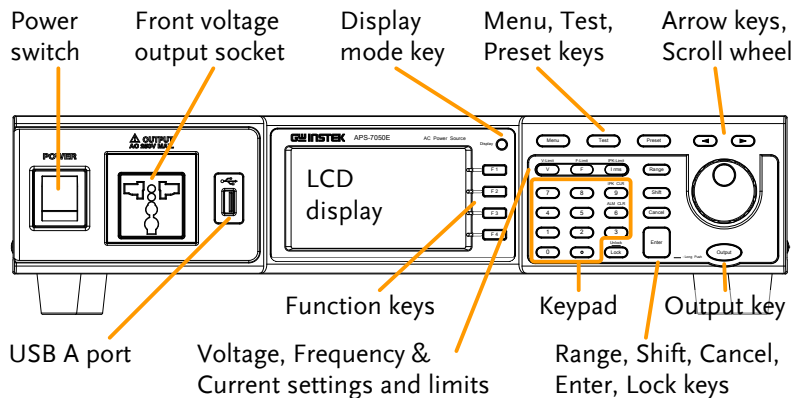

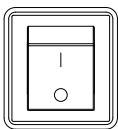
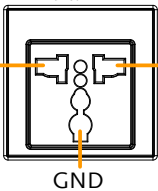





Item	Description
Power Switch	<p>POWER</p>  <p>Turns on the mains power.</p>
Front Voltage Output Socket	<p>OUTPUT AC 250V MAX.</p>  <p>Output voltage terminal using a regional universal plug. There is a Euro and a Universal regional plug.</p>



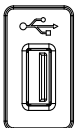

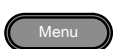
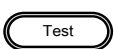
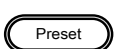

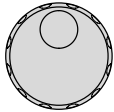

CAUTION

Maximum allowable output voltage and current are 250Vrms and 10Arms.

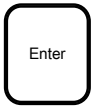
For voltages exceeding 250Vrms, please use the rear output terminal.

USB A Port		The USB port is used for upgrading software.
LCD Screen		Displays the measured values or menu system.
Display Mode Select Key		Selects between Standard mode and Simple mode.
Function Keys		Assigned to the functions displayed on the right-hand side of the screen.
Menu Key		Enters the Main menu or goes back to one of the display modes.
Test Key		Puts the instrument into the Test mode.
Preset Key		Puts the instrument into Preset mode.
Arrow Keys		The arrow keys are used to select the digit power of a value that is being edited.
V		Used for setting the output voltage.
V-Limit	(Shift + V)	Used for setting the output voltage limit value.
F		Used for setting the output frequency.
F-Limit	(Shift + F)	Used for setting the output frequency limit value.
I rms		Used for setting the maximum output current.
IPK-Limit	(Shift + I rms)	Used to set the peak output current limit value.

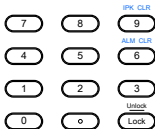
Range Key		Switches between the 155V and 310V ranges.
Scroll Wheel		Used to navigate menu items or for incrementing/decrementing values one step at a time.
Lock Key		Locks the number pad to prevent accidentally changing panel settings.
Unlock Key (Long press)		Disables the key lock.
Enter Key		Confirms selections / settings
Cancel Key		Clears entries that are made in the number entry dialog when a value is edited using the arrow keys or the scroll wheel. The Cancel key can also be used to cancel function setting menus or dialogs.
Shift Key		Turns on the shift state, which enables shortcut operations.
Output Key		Turns the output on or off.
Number Pad		Used to enter values.
ALM CLR	(Shift + 6)	Clears alarms.
IPK CLR	(Shift + 9)	Clears peak current hold.

Rear Panel

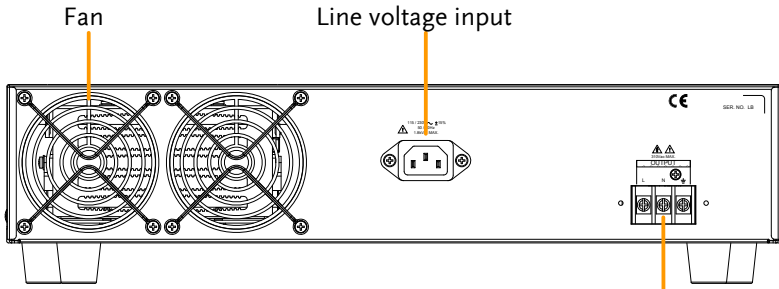

APS-7050E

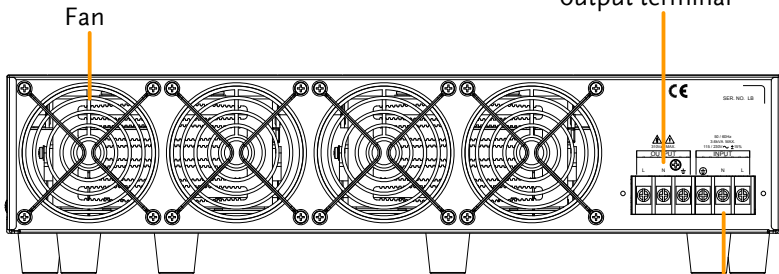

APS-7100E

Line Voltage Input

APS-7050E

Voltage Input: 115/230±15% VAC;
Line frequency: 50Hz/60 Hz
(Automatically switchable)

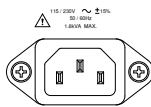

APS-7100E

Voltage Input: 115/230±15% VAC ; Line frequency: 50Hz/60 Hz (Automatically switchable)

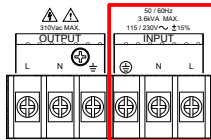

Rear Voltage
Output Socket

Output voltage terminal.

APS-7050E

APS-7100E

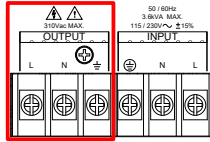
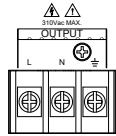

FAN

Temperature controlled fan.

Status Bar Icons

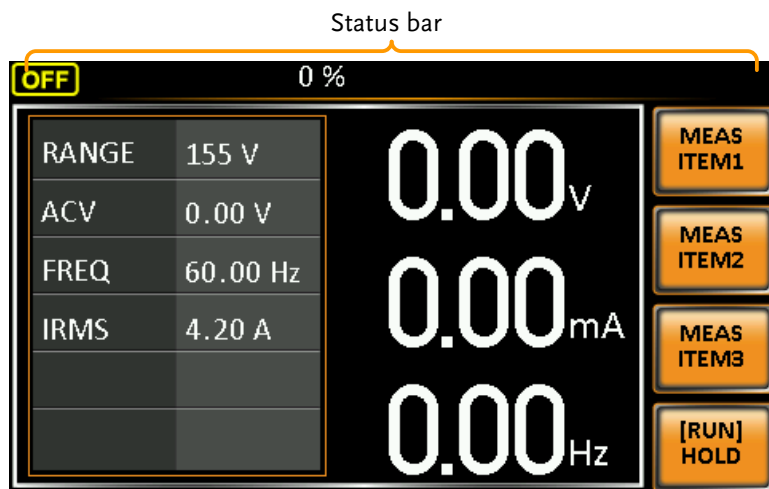

Indicates if the output is ON or OFF.



Indicates the output power as a percentage of full scale.



The alarm icon will appear on the status bar when one of the protection functions are tripped. Applies to Over Power, Over Irms, Over Ipeak and Over Temperature protection.



Indicates that a USB drive is detected in the front panel host port.



Indicates that the panel lock is active.

OPERATION

Set Up	20
Line Voltage Connection (APS-7100E).....	20
Power Up.....	23
Output Terminals	24
Using the Rack Mount Kit	28
How to Use the Instrument	28
Reset to Default Settings	32
View System Version and Serial Number.....	33
LCD Configuration	34
Buzzer.....	35
Basic Operation	36
Setting the Voltage Range.....	36
Setting the Voltage Limit	37
Setting the Output Voltage.....	38
Setting the Frequency Limit	40
Setting the Output Frequency.....	41
Setting the Peak Current Limit	42
Setting the Current RMS Level.....	45
Alarm Clear.....	48
Display Modes.....	49
Panel Lock	51
Turning the Output On	52
Preset Settings	53
Save Preset Settings to Local Memory.....	53
Load Preset Settings to Local Memory.....	54
Manage Preset Settings.....	55
Test Mode Function	57
Test Mode Overview.....	58
Test Settings	60
Save a Test to Local Memory.....	62

Recall a Test from Local Memory	62
Manage Test Settings.....	63
Running a Test	65

Set Up

Line Voltage Connection (APS-7100E)

Background The APS-7100E is equipped with an input power terminal that can accept 115V/230V \pm 15%. To connect or replace the power cord (GW Instek part number: APS-7100E: 4300-31000101, use the procedure below:



The following procedure should only be attempted by competent persons.

Ensure the AC power cord is not connected to power.

Removal

1. Turn off the power switch.

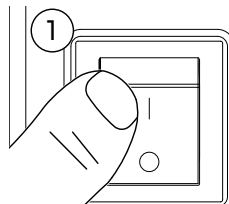

APS-7100E

2. Unscrew the power cord strain relief on the rear output socket.
3. Remove the 2 screws holding the power cord cover and remove.

APS-7100E

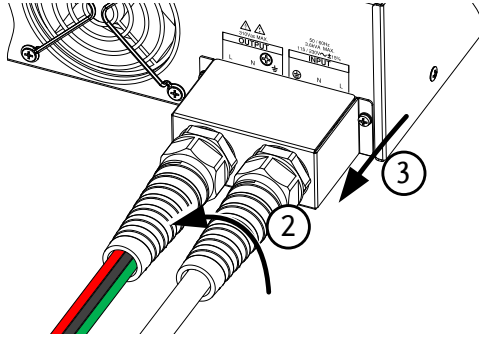

4. Remove the AC power cord wires.

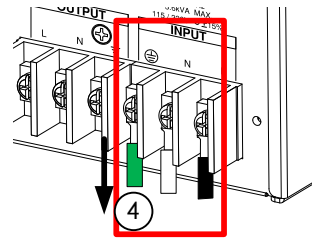

 **CAUTION**

The power line inputs for the APS-7100E are on the outer cluster of terminals.

The terminals to the inner of the panel are the rear panel outputs.

Installation

1. Connect the AC power cord wires to the AC input terminals.

- White/Blue → Neutral (N)
- Green/Green-yellow → GND (⊥)
- Black/Brown → Line (L)

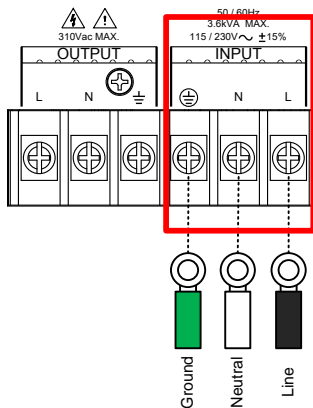

2. Re-install the power cord cover.
3. Screw the power cord strain relief back onto the cover.

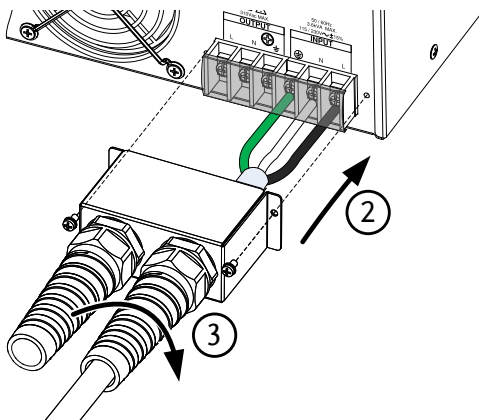

Power Up

Steps

1. Socket type: Connect the power cord to the rear panel socket.

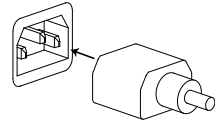

Input Power Terminal: Page 20
 Connect the power cord to the input power terminals.

2. Press the POWER key. The splash screen will appear momentarily before the continuous mode screen appears with the settings loaded.

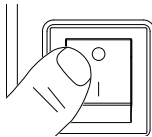

 **CAUTION**

The power supply takes around 10 seconds to fully turn on and shutdown.

Do not turn the power on and off quickly.

Output Terminals

Background The output terminals can be output from either the front panel or from the rear panel. The outputs are limited to 4.2A/2.1A (APS-7050E) or 8.4A/4.2A(APS-7100E).

Supported plugs Multi-region terminal Socket
Supported Standards:

- IEC, North America, Japan.
- EURO CEE type universal plug

 **WARNING** Dangerous voltages. Ensure that the power to the instrument is disabled before handling the power supply output terminals. Failing to do so may lead to electric shock.

 **CAUTION** For the front panel output, the maximum output voltage is 250VAC and current is 10A.

- Front Panel Output Connection**
1. The front panel has a multi-region power socket depending on the socket type.
 2. Insert the plug from the DUT into the socket.

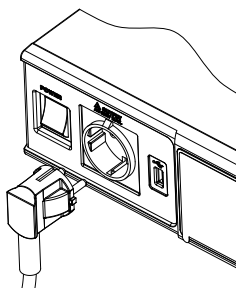

EURO CEE socket

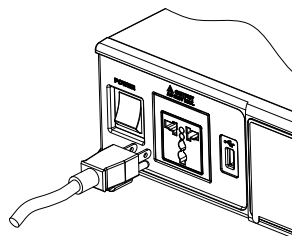

IEC North America, Japan

3. Turn the power on. The AC power supply is now ready to power the DUT.

Rear Panel Output Connection

The rear panel output is used to supply higher power DUTs. The rear panel output connection is similar to the universal rear panel line input connection on the APS-7100E.

1. Disconnect the unit from the mains power socket and turn the power switch off.
2. Unscrew the power cord strain relief.
3. Remove the 2 screws holding the power cord cover and remove.

APS-7050E

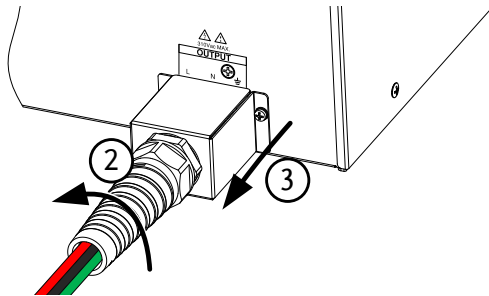

APS-7100E

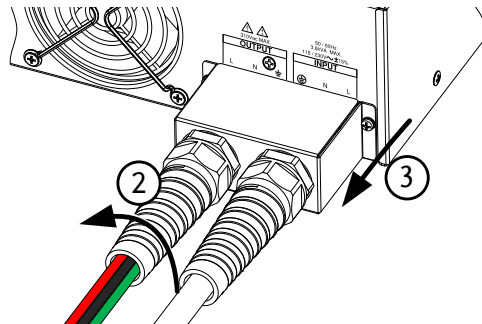



CAUTION

For the APS-7100E, there is a single bank for the input and output terminals. Ensure the correct terminals are connected. The APS-7050E only has a single bank of output terminals on the rear panel.

Installation

4. Connect the output AC power cord wires to the output terminals.

- Black → Neutral (N)
- Green → GND (⊥)
- Red → Line (L)

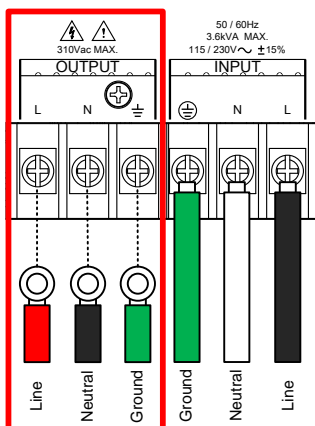

APS-7100E shown. The input terminals are already connected and shows which output terminals are to be connected.

5. Re-install the power cord cover.
6. Screw the power cord strain relief back onto the power cord cover.

APS-7100E

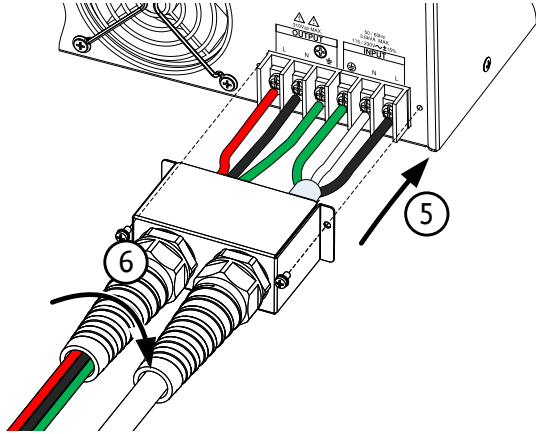

APS-7050E

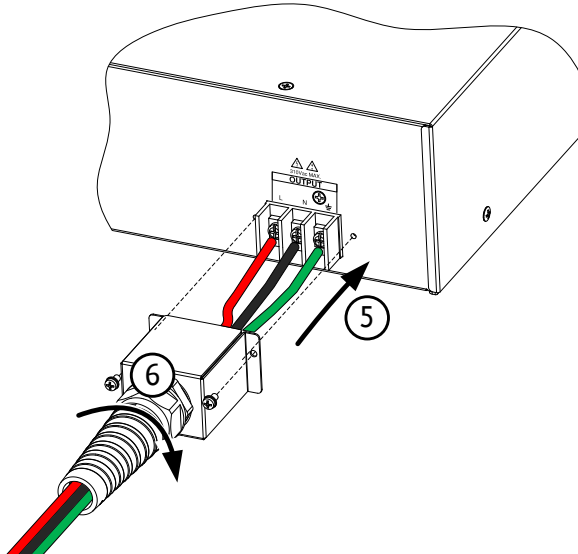

7. Turn the power on. The AC power supply is now ready to power the DUT.

Using the Rack Mount Kit

Background

The APS-7000E series has an optional Rack Mount Kit (GW Instek part number: GRA-423). The APS-7050E and APS-7100E are designed to fit into a 2U rack height. Please see your distributor for further rack mount details.

Rack mount diagram

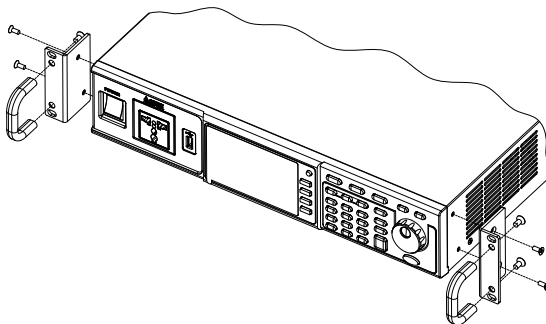

CAUTION

Ensure adequate ventilation is provided when using the rack mount. Ensure that a gap of at least 50mm is given for the side air intakes. Failure to do so may cause the instrument to overheat.

How to Use the Instrument

Background

The APS-7000E AC power supplies generally use the scroll wheel, arrow keys and Enter keys to edit numerical values or to select menu options.

Menu navigation is performed using the menu keys and function keys on the front panel.

The following section will explain some of these concepts in detail.

Selecting Menu Items

1. Turn the scroll wheel to select parameters in menus and lists. The selected parameter will be highlighted in orange. The scroll wheel is also used to increment/decrement setting values.

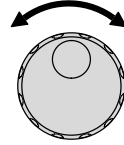

2. Press the Enter key to edit the parameter or to enter the selected menu.



Example

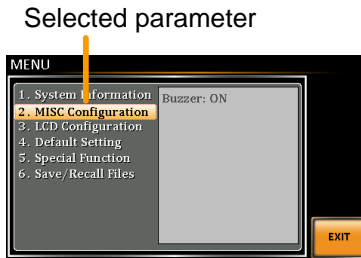

The following is an example of the menu list that appears when the Menu key is pressed.

Using the Keypad to edit parameter values

When editing a value the keypad can be used to directly enter the desired value.

1. Type the value of the parameter using the keypad.

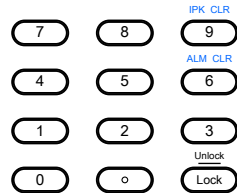

2. Press the Enter key to confirm the edit.



Example

Parameter

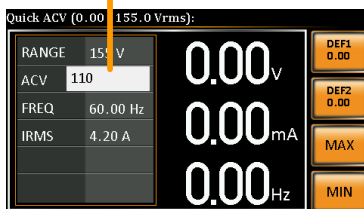

Using the Arrow Keys and Scroll Wheel to edit parameter values

Use the arrow keys to select a digit power and then use the scroll wheel to edit the value by that power.

1. Use the arrow keys to move the cursor to the digit of the desired power.
2. Turn the scroll wheel to edit the value by the resolution of the selected digit.

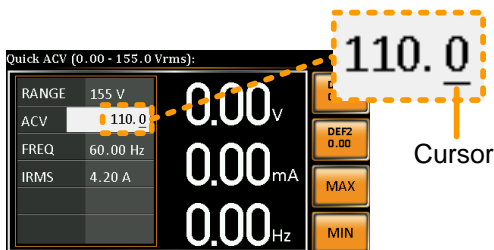
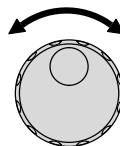

3. Repeat the steps above for all the relevant digits.
4. Press the Enter key to confirm the edit.





Note

By default the cursor starts at the lowest power digit.

Using the
Function Keys

The function keys (F1 ~ F4) are quick settings keys, the function of which depends on the current menu or operation.

1. Press the function key that corresponds to the setting directly to its left.
2. The setting or parameter is immediately executed.

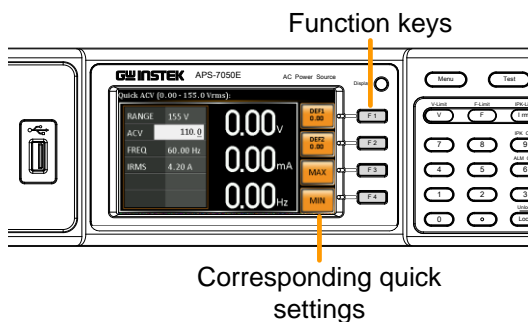

3. Repeat the steps above for all the relevant digits.

Reset to Default Settings

Background The default settings can be restored from the Menu key settings. See page 70 for the default factory settings.

- Steps**
1. Press the *Menu* key. The Menu settings will appear on the display. 
 2. Use the scroll wheel to go to item 4, *Default Setting*.
 3. Press *Enter* x2 to restore the default settings.

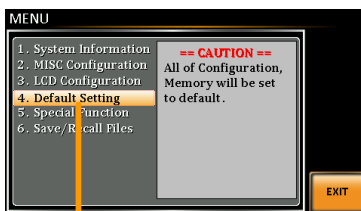

Default settings

View System Version and Serial Number

Background The Menu>System Information setting displays the serial number and version number.

Steps

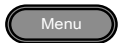
1. Press the Menu key. The Menu setting will appear on the display. 
2. The system information should now be listed on the display.

If not, use the scroll wheel to go to item 1, *System Information*.

System Information

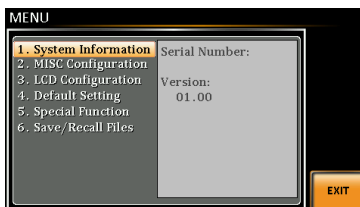

LCD Configuration

Background The LCD Configuration setting sets the brightness, contrast and saturation level of the LCD display.

- Steps**
1. Press the *Menu* key. The Menu settings will appear on the display. 
 2. Use the scroll wheel to go to item 3, *LCD Configuration* and press *Enter*.
 3. Set the brightness, contrast and saturation.
 - Contrast(%) 1 ~ 100% (Default=50%)
 - Brightness(%) 1 ~ 100% (Default=50%)
 - Saturation(%) 1 ~ 100% (Default=50%)

- Exit**
4. Press *Exit*[F4] to exit from the Ramp Control settings. 

- Default Settings**
5. Press *Default*[F3] to set all the LCD settings to 50%.

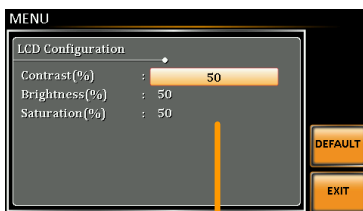

Default settings

LCD settings

Buzzer

The Buzzer setting turns the buzzer sound on or off for key presses and alarms.

Steps

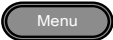
1. Press the *Menu* key. The Menu setting will appear on the display. 
 2. Use the scroll wheel to go to item 2, *MISC Configuration* and press *Enter*.
 3. Go to the *Buzzer* setting using the scroll wheel and press *Enter*. Turn the setting on or off and press *Enter* again to confirm.
-

Buzzer ON, OFF

Exit

4. Press *Exit*[F4] to exit from the MISC Configuration settings. 
-

Example

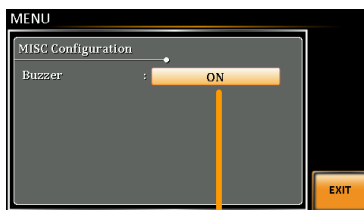

Settings

Basic Operation

This section describes the basic operations required to operate the power supply.

- Setting the Voltage Range → from page 36
- Setting the Voltage Limit → from page 37
- Setting the Output Voltage → from page 38
- Setting the Frequency Limit → page 40
- Setting the Output Frequency → page 41
- Setting the Peak Current Limit → from page 42
- Setting the Current RMS Level → from page 45
- Clearing the Alarm → from page 48
- Setting the Display mode → from page 49
- Panel lock → from page 51
- Turning the Output on/off → from page 52

Before operating the power supply, please see the Getting Started chapter, page 8.

Setting the Voltage Range

Background	The Range setting determines the general outlet voltage range. The ranges available correspond to common mains output voltage standards.
------------	--

- | | |
|-------|--|
| Steps | 1. Press Range to access the Range menu.  |
| | 2. Set the voltage range with the scroll wheel or with the F1 ~ F4 soft-keys. |
-

Range	AUTO, 310V, 155V
-------	------------------

- | | |
|--|--|
| | 3. Press Enter to confirm the Range setting. |
|--|--|
-

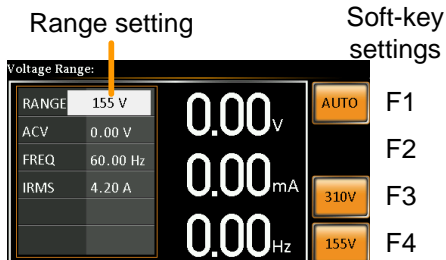

Note

If the range is changed from 155V to 310V, the Irms and IPK values will automatically be changed to a lower value. If the range is changed from 300V to 155V, the Irms and IPK values remain the same.

If the voltage range is changed when the output is on, the output will be automatically turned off.

Setting the Voltage Limit

Background Setting the voltage limit allows the output voltage to be set to any level within the voltage limit (V Limit) range.

Steps 1. Press *Shift* + *V* to access the Volt Limit menu.

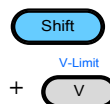

2. Set the voltage limit with the scroll wheel or with the F3 ~ F4 soft-keys. The MAX and MIN soft-keys set the limit to the maximum and minimum, respectively.

Range	10% of full range ~ full range
-------	--------------------------------

Soft-keys	MAX, MIN
-----------	----------

3. Press *Enter* to confirm the voltage limit setting.

Volt Limit

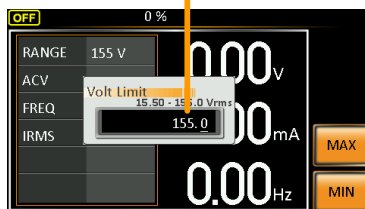

Min/Max settings

F3

F4



Note

Each voltage range (155V, 310V) has an independent voltage limit.

Setting the Output Voltage

Background

The voltage setting sets the voltage level of the power supply.



Note

Before setting the power supply voltage level, set the voltage range and voltage limit.

Steps

1. Press the V key. The ACV parameter will be editable.
2. Set the voltage with the scroll wheel/keypad or with the F1 ~ F4 soft-keys.

V-Limit



Range 0 volts ~ full range

Soft-keys DEF1, DEF2, MAX, MIN

3. Press *Enter* to confirm the voltage setting.

Preset Settings

The DEF1 and DEF2 preset settings are user defined settings. By default they are set to 0.00 volts. The MAX and MIN soft-keys set the voltage to the maximum and minimum, respectively.

4. Press the *V* key and set the desired voltage with the scroll wheel/keypad.

Range 0 volts ~ full scale of voltage range

5. Press and hold the DEF1 or DEF2 soft-key until "Saved to DEF1/2" is displayed. This will save the voltage setting to the DEF1 or DEF2 soft-key.

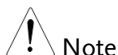

Note

Trying to set the voltage outside of the voltage limit/range will result in a voltage setting error being displayed on the screen.

The voltage level can be set when the output is on.

Example

Voltage setting	Preset voltage settings												
<div style="border: 1px solid black; padding: 5px;"> <p style="font-size: small;">Quick ACV (0.00 - 155.0 Vrms):</p> <table border="1" style="width: 100%; border-collapse: collapse;"> <tr> <td style="padding: 2px;">RANGE</td> <td style="padding: 2px;">155 V</td> </tr> <tr> <td style="padding: 2px;">ACV</td> <td style="padding: 2px;">110.0</td> </tr> <tr> <td style="padding: 2px;">FREQ</td> <td style="padding: 2px;">60.00 Hz</td> </tr> <tr> <td style="padding: 2px;">IRMS</td> <td style="padding: 2px;">4.20 A</td> </tr> <tr> <td style="padding: 2px;"> </td> <td style="padding: 2px;"> </td> </tr> <tr> <td style="padding: 2px;"> </td> <td style="padding: 2px;"> </td> </tr> </table> </div>	RANGE	155 V	ACV	110.0	FREQ	60.00 Hz	IRMS	4.20 A					<div style="display: flex; flex-direction: column; align-items: center;"> <div style="margin-bottom: 20px;"> <p style="font-size: 2em; margin: 0;">0.00</p> <p style="margin: 0;">V</p> </div> <div style="margin-bottom: 20px;"> <p style="font-size: 2em; margin: 0;">0.00</p> <p style="margin: 0;">mA</p> </div> <div> <p style="font-size: 2em; margin: 0;">0.00</p> <p style="margin: 0;">Hz</p> </div> </div> <div style="display: flex; flex-direction: column; align-items: center; margin-top: 20px;"> <div style="margin-bottom: 10px;"> <div style="border: 1px solid black; padding: 2px 5px; font-size: small;">DEF1</div> <div style="border: 1px solid black; padding: 2px 5px; font-size: x-small;">0.00</div> </div> <div style="margin-bottom: 10px;"> <div style="border: 1px solid black; padding: 2px 5px; font-size: small;">DEF2</div> <div style="border: 1px solid black; padding: 2px 5px; font-size: x-small;">0.00</div> </div> <div style="margin-bottom: 10px;"> <div style="border: 1px solid black; padding: 2px 5px; font-size: small;">MAX</div> </div> <div> <div style="border: 1px solid black; padding: 2px 5px; font-size: small;">MIN</div> </div> </div> <div style="display: flex; flex-direction: column; align-items: center; margin-top: 10px;"> <div style="margin-bottom: 10px;">F1</div> <div style="margin-bottom: 10px;">F2</div> <div style="margin-bottom: 10px;">F3</div> <div>F4</div> </div>
RANGE	155 V												
ACV	110.0												
FREQ	60.00 Hz												
IRMS	4.20 A												

Setting the Frequency Limit

Background Setting the frequency limit allows the frequency output to be set to any level within the limit range.

- Steps**
1. Press *Shift + F* to access the Freq Limit menu.

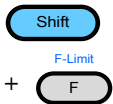

 2. Set the frequency limit with the scroll wheel/keypad or with the F3 ~ F4 soft-keys. The MAX and MIN soft-keys set the frequency limit to the maximum and minimum, respectively.

Range	45.00 ~ 500.0Hz
Soft-keys	MAX, MIN

 3. Press *Enter* to confirm the limit setting.

Example

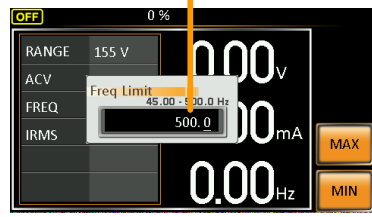
Freq Limit



Min/Max settings

MAX F3

MIN F4

Setting the Output Frequency

The frequency setting sets the frequency of the output.

Background	Before setting the frequency, set the frequency limit.				
Steps	<ol style="list-style-type: none"> Press the <i>F</i> key. The FREQ parameter will be editable.  Set the frequency with the scroll wheel/keypad or with the F1 ~ F4 soft-keys. <table border="1" data-bbox="426 592 997 691"> <tr> <td>Range</td> <td>45.00 ~ 500.0Hz</td> </tr> <tr> <td>Soft-keys</td> <td>DEF1, DEF2, MAX, MIN</td> </tr> </table> Press <i>Enter</i> to confirm the frequency setting. 	Range	45.00 ~ 500.0Hz	Soft-keys	DEF1, DEF2, MAX, MIN
Range	45.00 ~ 500.0Hz				
Soft-keys	DEF1, DEF2, MAX, MIN				
Preset Settings	<p>The DEF1 and DEF2 preset settings are user defined settings. By default they are set to 50.00Hz and 60.00Hz, respectively. The MAX and MIN soft-keys set the frequency to the maximum and minimum, respectively.</p> <ol style="list-style-type: none"> Press the <i>F</i> key and set the desired frequency with the scroll wheel/keypad. <table border="1" data-bbox="426 1062 997 1110"> <tr> <td>Range</td> <td>45.00 ~ 500.0Hz</td> </tr> </table> Press and hold the DEF1 or DEF2 soft-key until "Saved to DEF1/2" is displayed. This will save the frequency setting to the DEF1 or DEF2 soft-key. 	Range	45.00 ~ 500.0Hz		
Range	45.00 ~ 500.0Hz				

Example

Frequency setting	Preset frequency settings
-------------------	---------------------------

The screenshot shows the 'Quick Freq (45.00 - 100.0 Hz):' menu. On the left, there are settings for RANGE (155 V), ACV (110.0 V), FREQ (60.00), and IRMS (4.20 A). On the right, there are three large digital displays showing 0.00 V, 0.00 mA, and 0.00 Hz. To the right of these displays are four preset frequency buttons: DEF1 (50.00), DEF2 (60.00), MAX, and MIN. Labels F1, F2, F3, and F4 are placed to the right of these buttons respectively. A vertical orange line is drawn through the FREQ field and the DEF1 button.

 Note

Trying to set the frequency outside of the frequency limit will result in a frequency setting error being displayed on the screen.

The frequency can be set when the output is on.

Setting the Peak Current Limit

Background

Setting the peak current limit sets a limit on the current that can be sourced by the power supply.

 Note

When the peak current limit is tripped, an alarm will sound. Press Shift + 9 to clear the I_{pk} alarm.

Shift+6 can also clear the I_{pk} alarm. See page 48 for details.

Steps

1. Press *Shift* + *I rms* to access the I_{peak} menu.

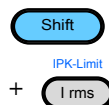

- Set the peak current with the scroll wheel/keypad or with the F3 ~ F4 soft-keys. The MAX and MIN soft-keys set the peak current to the maximum and minimum, respectively.

Range 10% ~ 100% peak current value. The peak current value depends on the selected voltage range.

Soft-keys MAX, MIN

- Press *Enter* to confirm the peak current setting.

Example

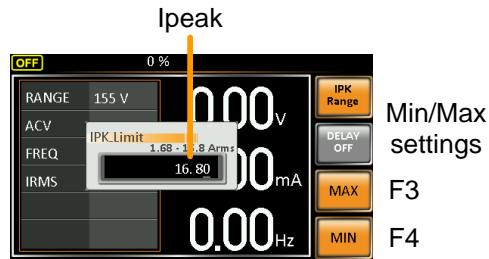

Delay Time Settings

The Delay Time setting essentially defines how long the measurement of the peak current must be sustained for before it is recognized. By default the delay time is turned off.

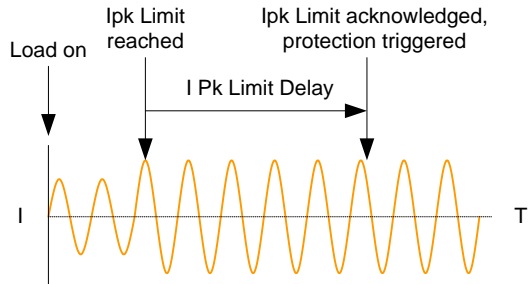

1. Press *Shift + I rms* and then press *DELAY[F2]*.
2. Set the desired delay time with the scroll wheel/keypad or with the F3 ~ F4 soft-keys. The MAX and MIN soft-keys set the delay time to the maximum and minimum, respectively.

Range 0(off) ~ 10 seconds

Soft-keys MAX, MIN

3. Press *Enter* to confirm the delay time setting.

Example

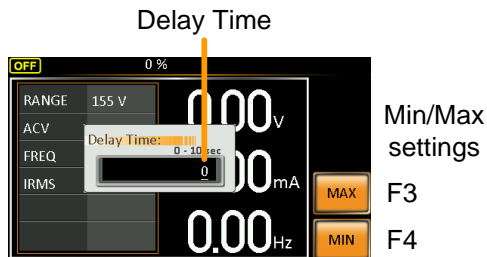

IPK Measurement Range Settings

The IPK Range settings allow you to manually set the peak current measurement range. By default this setting is set to AUTO.

1. Press *Shift + I rms* and then press *IPK Range[F1]*.
2. Set the desired range with the scroll wheel.

Range AUTO, 0.28A, 1.4A, 14A, 70A

3. Press *Enter* to confirm the IPK Range setting.

Example

IPK Range settings

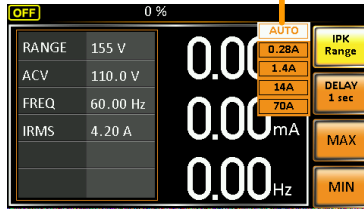

Setting the Current RMS Level

Background The I rms setting sets the root mean square current.

Steps

1. Press *I rms* to access the I rms menu. 
2. Set the I rms level with the scroll wheel/keypad or with the F3 ~ F4 soft-keys. The MAX and MIN soft-keys set the I rms level to the maximum and minimum, respectively.

Range 0.00 ~ full scale A (dependant on the voltage range)

Soft-keys MAX, MIN

3. Press *Enter* to confirm the current setting.

Example

I rms

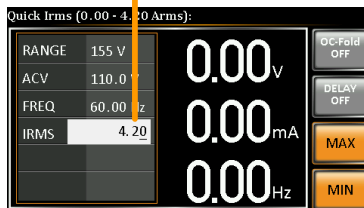

Min/Max settings

F3

F4



Note

Setting the I_{rms} level to 0.00 will disable OCP.

Setting I_{rms} to 0A is dangerous.

I_{rms} Delay Time Settings

The Delay Time setting defines how long the I_{rms} measurement must be sustained for before it is recognized. By default the I_{rms} delay time is turned off.

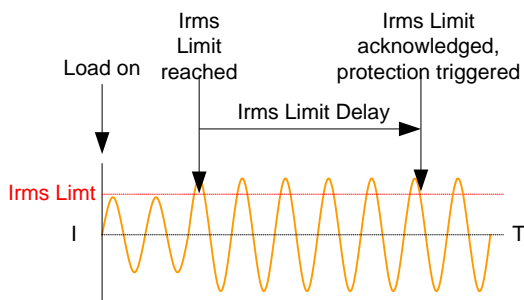

4. Press I_{rms} and then press *DELAY*[F2].
5. Set the desired delay time with the scroll wheel/keypad or with the F3 ~ F4 soft-keys. The MAX and MIN soft-keys set the delay time to the maximum and minimum, respectively.

Range	0(off) ~ 10 seconds
-------	---------------------

Soft-keys	MAX, MIN
-----------	----------

6. Press *Enter* to confirm the delay time setting.

Example

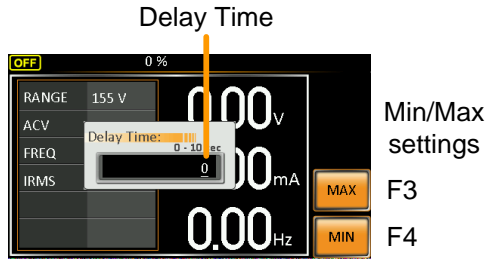

OC Fold Settings

The over current fold back settings allow the APS-7000E to work as either a constant voltage source or a constant current source.

While the unit is sourcing less current than the Irms current limit, the APS-7000E will act as a constant voltage source. In this mode, the voltage level will remain constant while the current level may vary. This is the normal operating mode.

When the current level reaches the Irms limit, the APS-7000E will act as a constant current source. In this mode the current is constant and the voltage level varies. When the current subsides below the Irms limit again, the unit will again act as a constant voltage source. When OC Fold is turned off, the APS-7000E will act as a current limiting power source when the Irms limit has been reached.

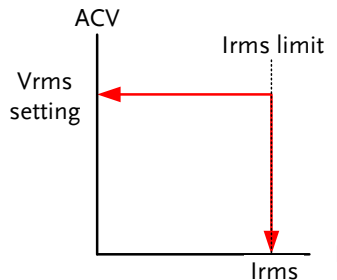



Note

OC-FOLD can only be active when the *I rms* level is greater than 0.

7. Press *I rms* and then press *OC-FOLD[F1]* toggle the OC-Fold function on or off.

OC-Fold setting

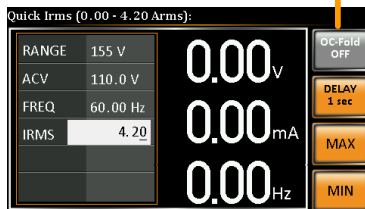

Alarm Clear

Background

The ALM CLR (Alarm Clear) function will clear any Over Power, Over Irms, Over Ipeak and Over Temperature alarms.

Applicable Alarms

OVER POWER, OVER IRMS, OVER IPEAK, OVER TEMPERATURE

Steps

1. Press *Shift* + 6 to clear any alarms.

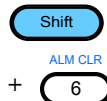

Example

ALM indicator

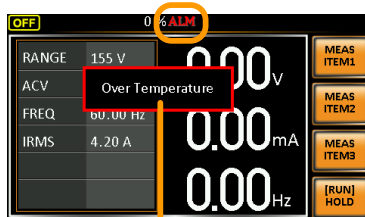

Alarm message

Display Modes

The APS-7000E power supply has two display modes. The standard display mode shows the power supply setup on the left and the 3 configurable measurements on the right. The simple display mode shows all measurement items available on the APS-7000E.

Steps

1. Press the *Display* key.



2. The display mode will toggle each time the key is pressed.

Standard Mode

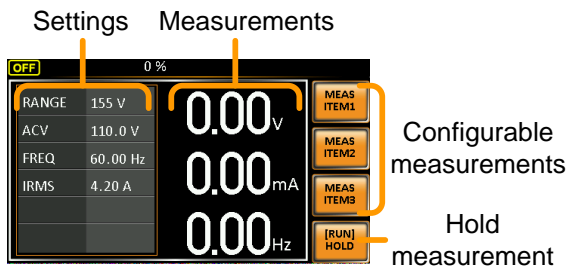

Simple Mode

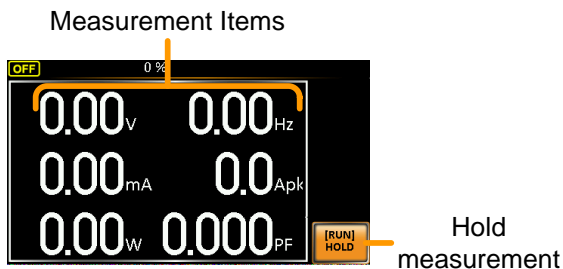

Configuring the Standard Mode Measurements

1. Press the *Meas Item1, Item2 or Item3* soft-key.



2. Use the scroll wheel to select a measurement item and press Enter to confirm.

Sets third measurement item to frequency

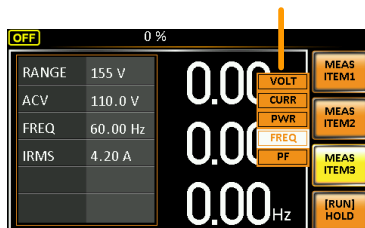

Hold
Measurement

The Hold function will “hold” the current measurements on the display. Measurements won’t be updated on the display until the function is released.

Press *HOLD*[F4] to toggle hold on or off.

Panel Lock

The panel lock feature prevents settings from being changed accidentally. When activated, all keys and knobs except the Lock/Unlock key and the Output key (if active) will be disabled.

Activate the panel lock

Press the *Lock* key to activate the panel lock. "Keys locked" appears on the display.



A lock icon will appear in the top corner when the panel keys are locked.



Disable the panel lock

Hold the *Lock* key for ~3 seconds to disable the panel lock. "Keys unlocked" will appear on the display and the padlock icon will disappear.



(hold)

Example

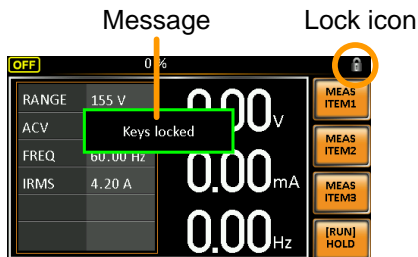

Turning the Output On

When the output is turned on, the DUT can be connected to either the rear panel output or the front panel output.



Warning

Both of these outputs are electrically linked. Only one DUT should be connected to any one of the outputs at a time. Using both outputs at the same time is not supported. Using the front and rear outputs at the same time could cause dangerous operating conditions. See page 24 for details about using the output terminals or sockets.

Turn Output On

Press the *Output* key. The Output key will light up and ON will be displayed in the status bar to indicate that the output is on.



Turn Output Off

Press the *Output* key. The Output key light will go out and OFF will be displayed in the status bar to indicate that the output is off.

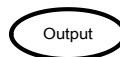



Preset Settings

- Save Presets to Local Memory → from page 53
- Recall Presets to Local Memory → from page 54
- Manage Preset Settings → from page 55

Save Preset Settings to Local Memory

Up to 10 preset settings can be saved to internal memory.

Steps

1. Press *Preset* and then hold a  *number key (0~9)* to save the present settings to the corresponding memory number.  (hold)
-
- | Presets | M0 ~ M9 |
|---------|---------|
|---------|---------|
-
2. Press the *Preset* key again to exit from the preset mode.

Example

For example, pressing *Preset* & holding *1* will save the present settings to memory slot 1 (saved to M1).



Note

The preset key will become green when active. A beep will be heard (Buzzer set to ON) and a message will displayed when the settings are saved.

Load Preset Settings to Local Memory

Any of the 10 preset settings can be recalled from internal memory.

Steps

1. Press *Preset* and press a *number key*(0~9) to load the corresponding memory number.

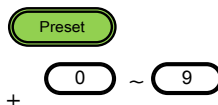

Presets	M0 ~ M9
---------	---------

2. Press the *Preset* key again to exit from the preset mode.
-

Example

For example, pressing *Preset* + 1 will recall the saved settings from memory slot 1 (recalled from M1).



Note

The preset key will become green when active. A beep will be heard (Buzzer set to ON) and a message will be displayed when the settings are recalled.

Manage Preset Settings

Preset settings can be easily saved to or from a USB flash drive using the Save/Recall Files utility in the Menu system. Files can also be deleted from local memory using the utility.

File Format	<p>When files are saved to USB they are saved in the following format: presetX.set, where X is the memory number M0 ~ M9. The files are saved to USB:/gw.</p> <p>When files are recalled from USB, files must be recalled from the same memory number. For example, the file preset0.set can only be recalled to memory number M0. The files can only be recalled from the USB:/gw directory.</p>
-------------	--

- | | |
|-------|--|
| Steps | <ol style="list-style-type: none"> 1. Press the <i>Menu</i> key. The Menu settings will appear on the display.  2. Use the scroll wheel to go to item 6, <i>Save/Recall Files</i> and press <i>Enter</i>. 3. Go to the <i>Type</i> setting using the scroll wheel and press <i>Enter</i>. Select <i>Preset</i> and press <i>Enter</i> to confirm. 4. Go to the <i>Action</i> setting and choose the file operation and then press <i>Enter</i>. |
|-------|--|

MEM→USB	Saves the selected preset memory from the local memory to a USB flash drive.
---------	--

MEM←USB	Loads a preset memory from a USB flash drive to the selected local memory.
---------	--

DELETE(MEM)	Deletes the selected preset memory from local memory.
-------------	---

- Go to the *Memory No.* setting and select the preset memory number to perform the operation on. Press *Enter* to confirm.

Memory No. 0 ~ 9 (M0 ~ M9)

Execute File Operation

- Press *Exe[F1]* to perform the file operation.



Exit

- Press *Exit[F4]* to exit from the *Save/Recall Files* settings.



Example



Settings

Test Mode Function

The Test Mode function is a quick and easy way to simulate fluctuations in voltage and frequency in mains supply power.

- Test Mode Overview → from page 58
- Test Settings → from page 60
- Manage Test Settings → from page 63
- Run Test → from page 65

Test Mode Overview

Background The Test function is used to test power supply fluctuation. This function is able to simulate common abnormalities in mains power such as fluctuations in voltage and frequency. These tests can be run as one-off anomalies or cyclic anomalies.

Setting Screen Overview

The screenshot shows the TEST configuration interface. At the top, there are two buttons: 'LO (HL)' and 'AUTO'. Below them is a waveform display showing a sine wave with a purple envelope and a yellow signal. The waveform is divided into segments labeled 'Init', 'Normal', 'Trans1', 'Abnormal', 'Trans2', 'Normal2', and 'Init'. Below the waveform is a table of settings:

Step	Initial	Repeat	1
Time	0.10 s		
Vset	0.00		
Fset	50.00		

On the right side of the screen are three buttons: 'Recall None', 'Save None', and 'RUN'. Callouts with orange lines point to the following elements:

- Number of repetitions**: Points to the 'Repeat' field in the table.
- V RANGE**: Points to the 'Vset' field in the table.
- Recall test**: Points to the 'Recall None' button.
- Save test**: Points to the 'Save None' button.
- Run test**: Points to the 'RUN' button.
- Step time**: Points to the 'Time' field in the table.
- Step voltage**: Points to the 'Vset' field in the table.
- Step frequency**: Points to the 'Fset' field in the table.
- Step**: Points to the 'Step' field in the table.

Step Overview

The Test function is comprised of 6 steps. Each step is run sequentially in the following order: Initial, Normal1, Trans1, Abnormal, Trans2, Normal2, Initial.

Initial The Initial step is used as the initial and final settings of the waveform test. This is the standby step before the test starts and the standby step after the test ends.

Normal1 This step configures the normal output conditions that precede the abnormal conditions.

Trans1	This step configures the transition from normal to abnormal conditions. This step will linearly interpolate the normal settings to the abnormal settings. This step can be skipped for abrupt state changes.
Abnormal	This step contains the abnormal conditions for the test.
Trans2	This step configures the transition from abnormal to normal conditions.
Normal2	This step configures the normal conditions that supersede the abnormal conditions.

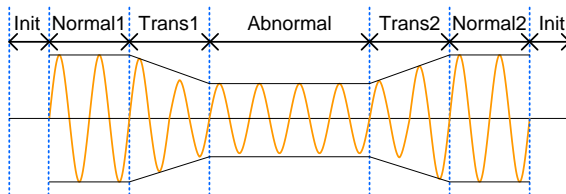

Parameter Overview

The following table shows which parameters are available for each step.

Step\Parameter	Initial	Normal1	Trans1	Abnormal	Trans2	Normal2
Repeat	✓	✓	✓	✓	✓	✓
Time	✓	✓	✓	✓	✓	✓
Vset	✓	✓	X	✓	X	✓
Fset	✓	✓	X	✓	X	✓

Repeat Indicates the number of times the test will be run, from Normal1 to Normal2.
A value of 0 indicates infinite repeats. The repeat setting is the same for each step.

Time Sets the duration time of the step.

Fset	Sets the frequency of the step. Not applicable for the Trans 1/2 steps.
------	---

Vset	Sets the voltage of the step. Not applicable for the Trans 1/2 steps.
------	---



Note

The start and stop phase for the test waveforms are arbitrary.

Test Settings

Entering the Test Menu 1. Press *Test*.

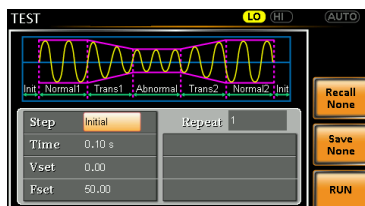
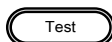

Steps

- Use the scroll wheel to go to the *Step* setting and press *Enter*.
- Use the scroll wheel to select one of the test steps and press *Enter*.

Steps	Initial, Normal1, Trans1, Abnormal, Trans2, Normal2
-------	---

- Go to the *Time* setting and set the duration of the step.

Time	0.01 ~ 99.99s, 0(Trans 1 and Trans2) Note: For Trans1 and Trans2, it supports a value of 0, which will skip the step.
------	--

- Press the *Range* key repeatedly to set the voltage range for the *Vset* parameter. The range will be shown in the top corner, which indicates that the test will be executed within this voltage range.

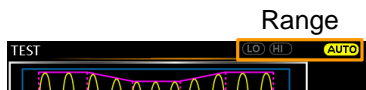

Range LO(155V), HI(310V), Auto

- Go to the *Vset* setting and set the *Vrms* level of the step. If you input a *Vset* value that is not within the voltage range, the input value will be ignored.

Not applicable for Trans1 and Trans2.

Vset 0.00 ~ 310.0Vrms (range dependent),
Auto

- Go to the *Fset* setting set the frequency of the step. Not applicable for Trans1 and Trans2.

Fset 45.00 ~ 500.0Hz

- Lastly, go to the *Repeat* parameter to select the number of times the test will repeat the Normal1-Trans1-Abnormal-Trans2-Normal2 sequence of steps. A value of 0 will set the number of repetitions to infinite.

Repeat 1 ~ 9999, 0(infinite)

Save a Test to Local Memory

Saving a Test Test settings can be saved to one of 10 memory slots (TEST0 ~ TEST9).

- Steps**
1. Press *Save*[F3] and then long press a *number key* when prompted.
 2. A message will appear when the save is successful.

Save TEST0 ~ TEST9

Recall a Test from Local Memory

Recall a Test Test settings can be recalled from one of 10 memory slots (TEST0 ~ TEST9).

- Steps**
1. Press *Recall*[F2] and then press a *number key* when prompted.
 2. A message will appear when the settings are recalled successfully.

Recall TEST0 ~ TEST9

Manage Test Settings

Test settings can be easily saved to or from a USB flash drive using the Save/Recall Files utility in the Menu system. Files can also be deleted from local memory using the utility.

File Format	<p>When files are saved to USB they are saved in the following format: testX.sim, where X is the memory number 0 ~ 9 (TEST0 ~ TEST9). The files are saved to USB:/gw.</p> <p>When files are recalled from USB, files must be recalled from the same memory number. For example, the file test0.sim can only be recalled to memory number TEST0. The files can only be recalled from the USB:/gw directory.</p>
-------------	--

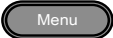
- | | |
|-------|--|
| Steps | <ol style="list-style-type: none"> 1. Press the <i>Menu</i> key. The Menu settings will appear on the display.  2. Use the scroll wheel to go to item 6, <i>Save/Recall Files</i> and press <i>Enter</i>. 3. Go to the <i>Type</i> setting using the scroll wheel and press <i>Enter</i>. Select <i>TEST</i> and press <i>Enter</i> to confirm. 4. Go to the <i>Action</i> setting and choose the file operation and then press <i>Enter</i>. |
|-------|--|
-

MEM→USB	Saves the selected test memory from the local memory to a USB flash drive.
---------	--

MEM←USB	Loads the test memory from a USB flash drive to the selected local memory.
---------	--

DELETE(MEM) Deletes the selected test memory from local memory.

- Go to the *Memory No.* setting and select the test memory number to perform the operation on. Press *Enter* to confirm.

Memory No. 0 ~ 9 (TEST0 ~ TEST9)

Execute File Operation

- Press *Exe[F1]* to perform the file operation.



Exit

- Press *Exit[F4]* to exit from the *Save/Recall Files* settings.



Example

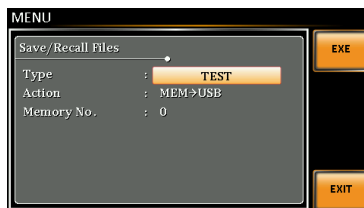

Settings

Running a Test

Background When running a test, the display changes to the run test view.

Run Screen Overview

Settings

The screenshot shows a 'TEST' screen with the following elements:

- Settings Section:** A box containing 'VSET 110.0 V' and 'FREQ 50.00 Hz'.
- Measurement Readouts:** '110.0 V', '0.00 W', '0.00 mA', '0.000 PF', '50.00 Hz', and '0.0 Ap'.
- Buttons:** 'HOLD' (orange) and 'STOP' (yellow).
- Step Indicator:** 'Step X of Y' at the top right.
- Labels:** 'Readback measurements' points to the measurement values, and 'Hold/Conti test' and 'Stop/Run test' point to the respective buttons.

Steps

1. Press *Output*.



2. Press *Run[F4]*. The test will start to run.

The settings of the current step will be shown at the top of the screen and the measurement readout will be shown on the bottom of the screen.

The top-right of the screen will display the current step number of the test.

- 1/5 = Normal1 2/5 = Trans1
- 3/5 = Abnormal 4/5 = Trans2
- 5/5 = Normal2

3. The test will continue to run until the last repeat step has run, *Stop[F4]* is pressed or the output is turned off*. When the test has finished/stopped, the screen will return to the original settings screen.

Hold Test To pause the test mid-way, press *Hold*[F3].

Continue Test To continue a paused test, press *Conti*[F3].

F AQ

- The accuracy does not match the specification.

The accuracy does not match the specification.

Make sure the device is powered On for at least 30 minutes, within +18°C~+28°C. This is necessary to stabilize the unit to match the specification.

For more information, contact your local dealer or GW Instek at www.gwinstek.com / marketing@goodwill.com.tw.

APPENDIX

Firmware Update

Background The APS-7000E firmware can be upgraded using the USB A port on the front panel. See your local distributor or the GW Instek website for the latest firmware information.



Note

- Ensure the DUT is not connected.
 - Ensure the output is off.
-

Steps

1. Insert a USB Flash Drive into the USB port on front panel of the APS-7000E.
 - The USB drive should include the “**gw.sbt**” **firmware** file in a directory named “gw” (USB:\gw:).
2. Press the *Menu* key. The Menu setting will appear on the display. 
3. Use the scroll wheel to go to item 5, *Special Function* and press *Enter*.
4. Key in the password when prompted and then press *Enter*.
 - The password is “5004”.
5. Go to Item 1, *Update Main Program* and press *Enter*.

Exit

6. Wait for the unit to update. Upon completion the unit will automatically reset.
-

Example

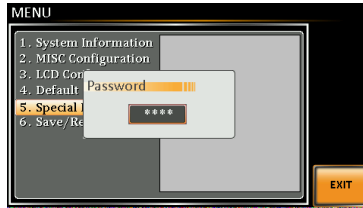

Password setting screen

APS-7000E Default Settings

The following default settings are the factory configuration settings for the power supply.

For details on how to return to the factory default settings, see page 32.

Continuous Mode	APS-7050E	APS-7100E
Range		155V
ACV		0.00V
FREQ		60.00Hz
IRMS	4.20A	8.40A
V limit		155.0Vrms
F Limit		500.0Hz
Ipeak Limit	16.80Arms	33.60Arms
Test Mode	APS-7050E	APS-7100E
Step		Initial
Repeat		1
Time		0.10s
Vset		0.00
Fset		50.00
Range		LO
Configuration Menu	APS-7050E	APS-7100E
Buzzer		ON
LCD Contrast		50%
LCD Brightness		50%
LCD Saturation		50%

APS-7000E Specifications

The specifications apply when the APS-7000E is powered on for at least 30 minutes.

APS-7000E

Model	APS-7050E	APS-7100E
AC Input		
Phase	Single Phase	
Voltage	115/230 Vac \pm 15%	
Frequency	50/60Hz	
Max. Current	16A / 8A	32A / 16A
Power Factor	0.7 Typ.	
AC Output		
Power Rating	500 VA	1000 VA
Output Voltage	0 ~ 155Vrms / 0 ~ 310.0 Vrms	
Output Frequency	45.00 ~ 500.0 Hz	
Maximum Current (r.m.s) ^{*1}		
0 ~ 155 Vrms	4.2 A	8.4 A
0 ~ 310 Vrms	2.1 A	4.2 A
Maximum Current (peak)		
0 ~ 155 Vrms	16.8 A	33.6 A
0 ~ 310 Vrms	8.4 A	16.8 A
Phase	Single Phase, Two Wire (1P2W)	
Total harmonic distortion (THD) ^{*2}	\leq 0.5% at 45 ~ 500Hz (Resistive Load)	
Crest factor	\geq 4	
Line regulation	0.1% (% of full scale)	
Load regulation	0.5% (% of full scale)	

Setting	
Voltage	
Range	0 ~ 155 Vrms, 0 ~ 310 Vrms, Auto
Resolution	0.01 V at 0.00 ~ 99.99 Vrms 0.1 V at 100.0 ~ 310.0 Vrms
Accuracy	± (0.5% of setting + 2 counts)
Frequency	
Range	45 ~ 500 Hz
Resolution	0.01 Hz at 45.00 ~ 99.99 Hz 0.1 Hz at 100.0 ~ 500.0 Hz
Accuracy	± 0.02% of Setting
Measurement ^{*3}	
Voltage (r.m.s)	
Range	0.20 ~ 38.75 Vrms
	38.76 ~ 77.50 Vrms
	77.51 ~ 155.0 Vrms
	155.1 ~ 310.0 Vrms
Resolution	0.01 V at 0.00 ~ 99.99 Vrms 0.1 V at 100.0 ~ 310.0 Vrms
Accuracy ^{*4}	± (0.5% of reading + 2 counts)
Frequency	
Range	45 ~ 500 Hz
Resolution	0.01 Hz at 45.00 ~ 99.99 Hz 0.1 Hz at 100.0 ~ 500.0 Hz
Accuracy	± 0.1 Hz
Current (r.m.s)	
Range	2.00 ~ 70.00 mA
	60.0 ~ 350.0 mA
	0.300 ~ 3.500 A
	3.00 ~ 17.50 A
Resolution	0.01 mA
	0.1 mA
	0.001 A
	0.01 A
Accuracy	± (0.6% of reading + 5 counts), 2.00 ~ 350.0 mA ± (0.5% of reading + 5 counts), 0.350 ~ 3.500 A ± (0.5% of reading + 3 counts), 3.500 ~ 17.50 A
Current (peak)	
Range	0.0 ~ 70.0 A
Resolution	0.1 A
Accuracy	± (1% of reading + 1 count)

Measurement continued next page.

Power (W)		
		0.01 W
Resolution		0.1 W
		1 W
		$\pm (0.6\% \text{ of reading} + 5\text{counts}), 0.20 \sim 99.99 \text{ W}$
Accuracy		$\pm (0.6\% \text{ of reading} + 5\text{counts}), 100.0 \sim 999.9 \text{ W}$
		$\pm (0.6\% \text{ of reading} + 2\text{counts}), 1000 \sim 9999 \text{ W}$
Power Factor		
Resolution		0.001
Accuracy		$\pm 2\% \text{ reading} + 2 \text{ counts}$
General		
Number of Preset		10 (0~9 numeric keys)
Protection		OCP, OPP, OHP and Alarm
Environmental Conditions		
Operating temperature range		0 ~ +40 °C
Storage temperature range		-10 ~ +70 °C
Operating humidity range		20 ~ 80% RH (no condensation)
Storage humidity range		80% RH or less (no condensation)
LCD Display		4.3 inch, 480 (RGB) x 272
Dimensions (mm)		
W	430	430
H	88	88
D	400	560
Weight	24Kg	38Kg
Test Function		
Number of Memories		10 (0~9 numeric keys)
Step Time Setting Range		0.01 ~ 99.99 S
Operation within Step		Constant, Keep, Linear Sweep
Parameters		Output Range, Frequency, Waveform (sine wave only)
Interface		
Standard		USB Host

Product specifications are subject to change without notice.

*1 At working voltage 120V / 240V.

*2 45Hz to 500Hz, 10% or higher of the rated output voltage, the maximum current or lower.

*3 All of measurement accuracy is at 23 \pm 5°C.

*4 In the case of 10V to 155V / 20V to 310V, sine wave, no load.

APS-7000E Dimensions

APS-7050E

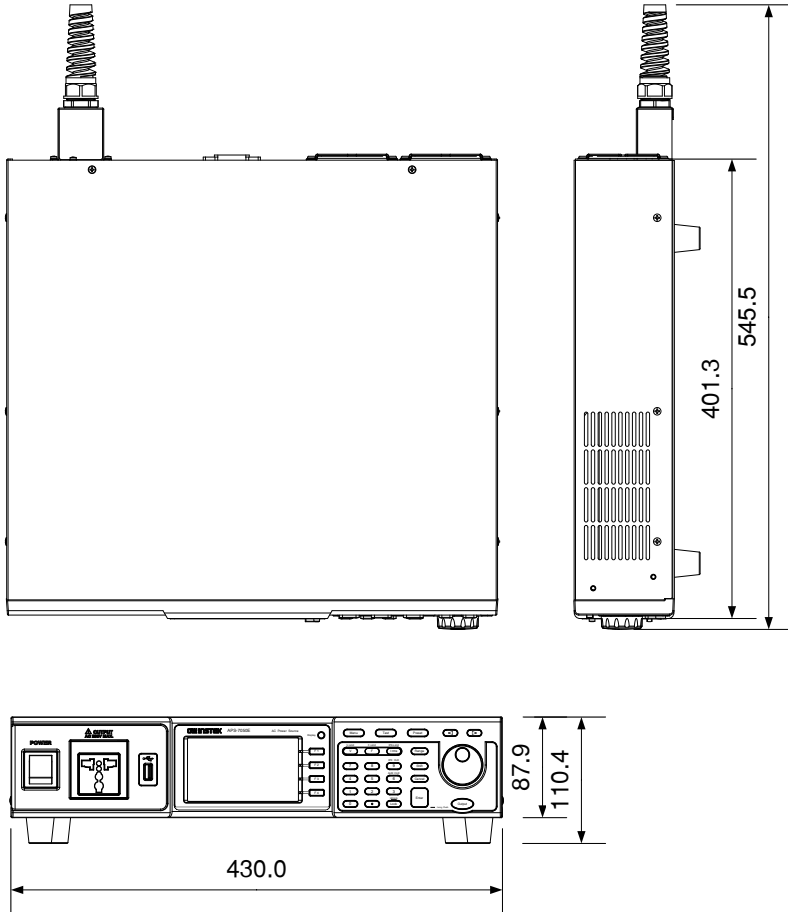

Scale = mm

APS-7100E

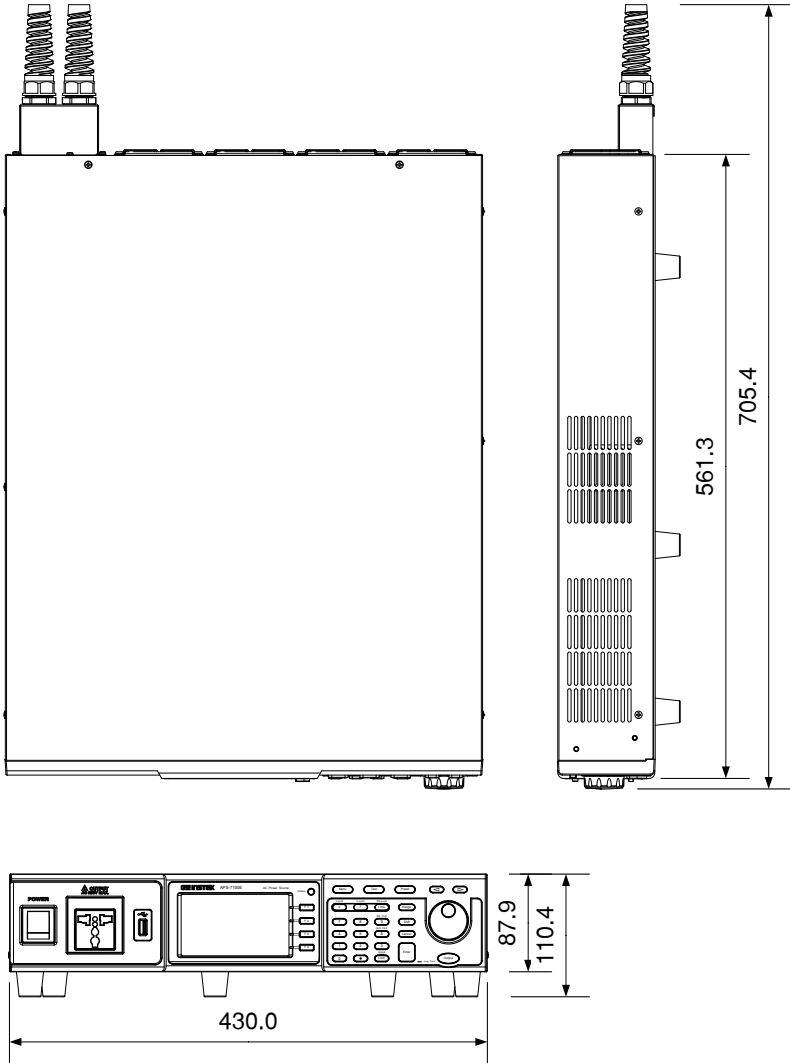

Scale = mm

Declaration of Conformity

We

GOOD WILL INSTRUMENT CO., LTD.

No. 7-1, Jhongsing Rd, Tucheng Dist., New Taipei City 236, Taiwan

GOOD WILL INSTRUMENT (SUZHOU) CO., LTD.

No. 69 Lushan Road, Suzhou New District Jiangsu, China.

declare that the below mentioned product

Type of Product: Programmable AC Power Source

Model Number: APS-7050E, APS-7100E

are herewith confirmed to comply with the requirements set out in the Council Directive on the Approximation of the Law of Member States relating to Electromagnetic Compatibility (2014/30/EU) and Low Voltage Directive (2006/95/EC & 2014/35/EU).

For the evaluation regarding the Electromagnetic Compatibility and Low Voltage Directive, the following standards were applied:

Ⓞ EMC	
EN 61326-1: EN 61326-2-1:	Electrical equipment for measurement, control and laboratory use -- EMC requirements (2013)
Conducted & Radiated Emission EN 55011: 2009 +A1: 2010 Class A	Electrostatic Discharge EN 61000-4-2: 2009
Voltage Fluctuations EN 61000-3-11: 2000	Radiated Immunity EN 61000-4-3: 2006 +A1: 2008 +A2: 2010
-----	Electrical Fast Transients EN61000-4-4: 2012
-----	Surge Immunity EN 61000-4-5: 2006
-----	Conducted Susceptibility EN 61000-4-6: 2014
-----	Power Frequency Magnetic Field EN 61000-4-8: 2010
-----	Voltage Dip/ Interruption EN 61000-4-34: 2007+A1: 2009

Low Voltage Equipment Directive 2006/95/EC & 2014/35/EU	
Safety Requirements	EN 61010-1: 2010

INDEX

Accessories	11	Load preset to local memory	54
Advanced settings		Load preset to USB	55
Buzzer	35	Load test to USB	63
Alarm clear	48	Marketing	
Buzzer	35	contact	67
Caution symbol	4	Model differences	9
Cleaning the instrument	6	OC fold	47
Clear alarm	48	Output on	52
Conventions	28	Output terminals	24
Current RMS	45	Peak current limit	42
Declaration of conformity	76	Power on/off	
Default settings	70	safety instruction	5
reset	32	Power up	23
Delay time	43	Preset settings	53
Delete test from memory	63	Rack mount	
Display mode		description	28
operation	49	Save preset to local memory	53
Disposal instructions	6	Save preset to USB	55
EN61010		Save test to USB	63
measurement category	5	Serial number	33
pollution degree	6	Service operation	
Environment		about disassembly	5
safety instruction	6	contact	67
Firmware update	68	Specifications	71
Frequency limit	40	System version	
Frequency output	41	view	33
Front panel diagram	12	Test	
Ground		Overview	58
symbol	4	Recall	62
I rms	45	Run	65
Ipk measurement range	44	Save	62
Ipk range	44	UK power cord	7
Ipk-Limit	42	Updating the firmware	68
Irms Delay time	46	Voltage limit	37
LCD configuration	34	Voltage output level	38
Line voltage		Voltage range	36
1000VA models	20	Warning symbol	4
List of features	10		