



S J ELECTRONICS
POWER • TEST & MEASUREMENT

0800 583 4455
sales@sjelectronics.co.uk

VISIT 
WEBSITE

Programmable High Precision DC Power Supply

PPH-1503

User Manual

GW INSTEK PART NO. 82PH-1503oE01



ISO-9001 CERTIFIED MANUFACTURER

GW INSTEK

Copyright Statement

This manual contains proprietary information, which is protected by copyright. All rights are reserved. No part of this manual may be photocopied, reproduced or translated to another language without prior written consent of Good Will company.

The information in this manual was correct at the time of printing. However, Good Will continues to improve products and reserves the rights to change specification, equipment, and maintenance procedures at any time without notice.

Table of Contents

SAFETY INSTRUCTIONS	5
OVERVIEW	11
Introduction	11
Key Features	13
Operating Principals.....	15
Front Panel	17
Rear Panel	23
Constant Voltage/Constant Current Crossover Characteristics.....	25
GETTING STARTED	27
Start Up.....	27
DVM and Load Connection	28
Turning the Output On/Off.....	29
BASIC OPERATION	31
Basic Power Supply Functions	31
DVM	41
Pulse Current Measurement	43
Long integration	49
Current Sink Function.....	54
External Relay Control	56
Save/Recall	59
Save Settings	59
Recall Settings.....	60
Restore Factory Default Settings.....	63

System Settings	64
System Information	64
Utility Settings.....	65
REMOTE CONTROL	67
Remote Control	67
Command Syntax.....	76
Command List	80
Command Details	85
SCPI Status Registers SCPI	121
Errors	129
APPENDIX	133
Replacing the Fuse	133
Specifications	134
Optional Accessories	136
Declaration of Conformity	137

S SAFETY INSTRUCTIONS

This chapter contains important safety instructions that you must follow during operation and storage. Read the following before any operation to insure your safety and to keep the instrument in the best possible condition.

Safety Symbols

These symbols may appear in the manual or on the instrument.



WARNING

Warning: Identifies conditions or practices that could result in injury or loss of life.



CAUTION

Caution: Identifies conditions or practices that could result in damage to the PSW or to other properties.



DANGER High Voltage



Attention Refer to the Manual



Protective Conductor Terminal



Earth (ground) Terminal



Do not dispose electronic equipment as unsorted municipal waste. Please use a separate collection facility or contact the supplier from which this instrument was purchased.

Safety Guidelines

General Guideline



CAUTION

- Do not place any heavy object on the unit.
- Avoid severe impact or rough handling that leads to damaging the unit.
- Do not discharge static electricity to the unit.
- Do not block the cooling fan opening.
- Do not perform measurements on circuits that are directly connected to mains power.
- Do not disassemble the PSW unless you are qualified.

(Measurement categories) EN 61010-1:2001 specifies the measurement categories and their requirements as follows. The PPH-1503 falls under category I.

- Measurement category IV is for measurement performed at the source of low-voltage installation.
- Measurement category III is for measurement performed in the building installation.
- Measurement category II is for measurement performed on the circuits directly connected to the low voltage installation.
- Measurement category I is for measurements performed on circuits not directly connected to Mains.

Power Supply



WARNING

- AC Input voltage range: 90VAC~264VAC
 - Frequency: 50Hz/60Hz
 - To avoid electrical shock connect the protective grounding conductor of the AC power cord to an earth ground.
-

Fuse



WARNING

- Fuse type: T2.0A/250V
- To prevent fire, replace the fuse only with the specified type and rating.
- Disconnect the power cord before replacing the fuse.
- Make sure the cause of fuse blowout is fixed before replacing the fuse.

Cleaning the power supply

- Disconnect the power cord before cleaning the oscilloscope.
- Use a soft cloth dampened in a solution of mild detergent and water. Do not spray any liquid into the oscilloscope.
- Do not use chemicals containing harsh products such as benzene, toluene, xylene, and acetone.

Operation Environment

- Location: Indoor, no direct sunlight, dust free, almost non-conductive pollution (Note below)
- Relative Humidity: < 80%
- Altitude: < 2000m
- Temperature: 0°C to 40°C

(Pollution Degree) EN 61010-1:2001 specifies pollution degrees and their requirements as follows. The PPH-1503 falls under degree 2.

Pollution refers to “addition of foreign matter, solid, liquid, or gaseous (ionized gases), that may produce a reduction of dielectric strength or surface resistivity”.

- Pollution degree 1: No pollution or only dry, non-conductive pollution occurs. The pollution has no influence.
 - Pollution degree 2: Normally only non-conductive pollution occurs. Occasionally, however, a temporary conductivity caused by condensation must be expected.
 - Pollution degree 3: Conductive pollution occurs, or dry, non-conductive pollution occurs which becomes conductive due to condensation which is expected. In such conditions, equipment is normally protected against exposure to direct sunlight, precipitation, and full wind pressure, but neither temperature nor humidity is controlled.
-

Storage
environment

- Location: Indoor
- Relative Humidity: < 70%
- Temperature: -10°C to 70°C

Power cord for the United Kingdom

When using the power supply in the United Kingdom, make sure the power cord meets the following safety instructions.

NOTE: This lead/appliance must only be wired by competent persons



WARNING: THIS APPLIANCE MUST BE EARTHED

IMPORTANT: The wires in this lead are coloured in accordance with the following code:

Green/ Yellow:	Earth
Blue:	Neutral
Brown:	Live (Phase)



As the colours of the wires in main leads may not correspond with the coloured marking identified in your plug/appliance, proceed as follows:

The wire which is coloured Green & Yellow must be connected to the Earth terminal marked with either the letter E, the earth symbol \oplus or coloured Green/Green & Yellow.

The wire which is coloured Blue must be connected to the terminal which is marked with the letter N or coloured Blue or Black.

The wire which is coloured Brown must be connected to the terminal marked with the letter L or P or coloured Brown or Red.

If in doubt, consult the instructions provided with the equipment or contact the supplier.

This cable/appliance should be protected by a suitably rated and approved HBC mains fuse: refer to the rating information on the equipment and/or user instructions for details. As a guide, a cable of 0.75mm² should be protected by a 3A or 5A fuse. Larger conductors would normally require 13A types, depending on the connection method used.

Any exposed wiring from a cable, plug or connection that is engaged in a live socket is extremely hazardous. If a cable or plug is deemed hazardous, turn off the mains power and remove the cable, any fuses and fuse assemblies. All hazardous wiring must be immediately destroyed and replaced in accordance to the above standard.

OVERVIEW

This chapter contains a brief introduction to PPH-1503, the main features, as well as an overview of the front and rear panel. Use the Getting Started chapter on page 27 to for start up instructions and how to setup the appropriate operation environment.

Introduction

Overview

The PPH-1503 is a portable high-speed programmable DC power supply with flexible operating configurations. In addition to the basic power supply functionality, it is also able to measure pulse current and the average current over long periods of time.

The PPH-1503 is designed for testing the power consumption of battery powered wireless communication devices (e.g. cell phones). Such devices often have large load variations within a short time span. The high precision power supply has excellent voltage stability during pulsed loads and is capable of simultaneously measuring the pulse current, even for very short pulses. In addition, the power supply is able to sink current, allowing it to simulate the characteristics of a discharged rechargeable battery for testing chargers and charge control circuits.

Basic Power Supply Function	The PPH-1503 works as a conventional power supply with automatic CC/CV crossover. Parameters such as the output voltage, current, read back refresh rate, data sampling period, power-on status, OVP and current range can be configured using the control panel. The voltage and current settings and the actual voltage/current are displayed on the LCD. For details, see page 31.
-----------------------------	---

Pulse Current Measurement Function	The PPH-1503 can measure the change in instantaneous current and the current of extremely short pulses. The readback refresh rate, data sampling period, trigger delay and trigger level can be set by the front panel keys and is displayed on the LCD. For details see page 43.
------------------------------------	---

Current Measurement over Long Periods	This function can measure the average current of one or more pulses. The readback refresh rate, trigger mode, and trigger timeout and trigger level settings are controlled by the front panel keys and is displayed on the LCD display. For details, see page 49.
---------------------------------------	--

Current Sink Features	When the voltage of an external power source is greater than the high-speed power supply output, the system will automatically work as an electronic load to sink current. For details, see page 54.
-----------------------	--

Digital Volt Meter	The PPH-1503 has a DVM function that can measure DC voltages in the range of 0~20VDC. For details, see page 41.
--------------------	---

Remote Control	To meet the various needs of customers, the PPH-1503 is designed for USB, GPIB and LAN remote control. For details, see page 67.
----------------	--

Additional Features The PPH-1503 has external relay control signals for customers. The relay control signals are synced to the pulse current measurement feature. For details, see page 56.

Key Features

Features

- Low noise: Thermostatically controlled fan.
- Compact, lightweight.
- 3.5 inch TFT display.

Operation

- Constant voltage and constant current operation (CV/CC).
- Output on/off control.
- Front and Rear output control key.
- Digital panel control.
- 5 groups of save/recall settings and 10 automatically generated power-on settings.
- Digital voltage and current settings.
- Software calibration.
- Alarm buzzer.
- Key lock function.

Protection Features

- Reverse polarity protection.
- Overvoltage and overcurrent protection (OVP/Trip).
- Overtemperature protection (OTP).

- Interface
- USB remote control.
 - GPIB remote control.
 - LAN remote control.

Operating Principals

Overview The PPH-1503 mainly consists of the follow components:

- AC to DC Switching power supply
- DC to DC Buck converter circuit
- Precision output control circuit

The block diagram below shows a function description of each of the circuits. The following page will show detailed decriptions of each component.

Block Diagram

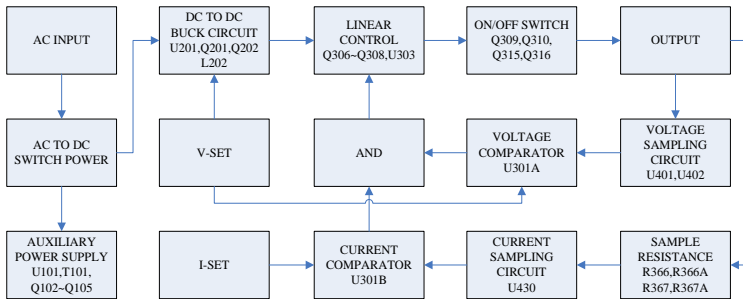

Switching Power Supply AC power is converted to 24VDC by the switch mode power supply module.

DC Down Conversion To reduce the input voltage to 24VDC (slightly higher than the settable voltage) the U201 Buck IC is used in conjunction with two power MOSFETS (Q201/Q202) and an inductor (L202).

Linear Output Circuit (Linear Regulator)	The Q306, Q307 dividers reduce the heat on a single component. The U303, U301, U403, U401 and U402 components form a control circuit to achieve accurate output.
--	--

Auxillary Power Supply	The independent auxillary DC power supply is achieved with the U101, T101 and Q102~Q105 components.
------------------------	---

Front Panel

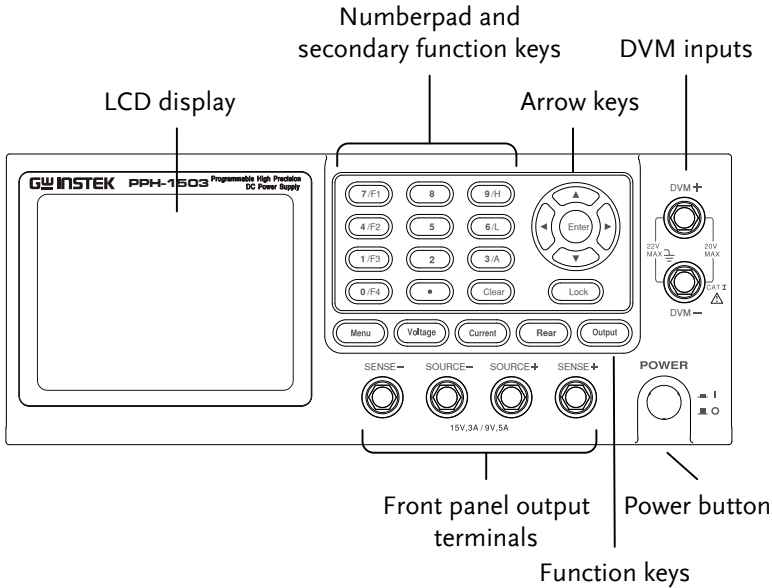

Display

Voltmeter Indicators Displays the output voltage with up to 5 digits of resolution. The default units are Volts (V).

15.000 V

Ammeter Indicator Displays the output current with up to 5 digits of resolution, depending on the current range (5A/5mA). The current range is selectable between A and mA.

5.0000 A or **5.0000 mA**

Setting Display Displays the voltage and current settings.

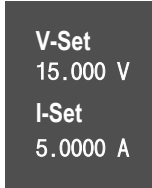

Parameter Settings Display Displays the parameter settings. For details on setting parameters, see page 20. The following figure shows the F1 parameter settings (V AND I), for example.



Status Display Display the current status of the instrument.

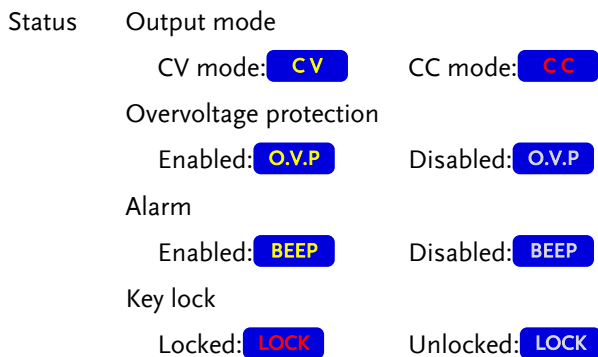

Remote connectivity

Local mode: **RMT** Remote: **GPIB**
 LAN
 USB

Output Switching the Output Source

Front: **FRONT** Rear: **REAR**

Output State

On: **ON** Off: **OFF**

Function Display Displays the unit functions. There four functions:

- F1: Basic power supply function (V AND I);
- F2: Digital Voltmeter function (DVM);
- F3: Pulse current meter function (PULSE);
- F4: Long integration current measurement function

The basic power supply function is shown below. (The active function is shown in yellow.)

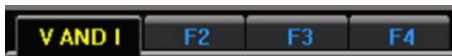

Function Keys

Menu key



Menu key to enter or exit from system settings.

Voltage Setting key

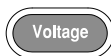

Press the Voltage key to set the voltage settings. See page 34 for operation details.

Current Setting key



Press the Current key to set the current settings. See page 35 for operation details.

Front and Rear output toggle key



Front and rear output toggle switch. The key will be lit when the output is set to the rear outputs.

Rear panel output:

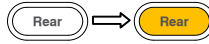

Output key



The Output key turns the output on or off. The Output key will light up when the output is on.



LOCK key



The Lock key is used to disable all the panel keys except for the Output key. Pressing the Lock key for at least 2 seconds will turn the panel lock on or off. The Lock key can also be used to exit from remote control mode. When the panel lock is active the Lock key will light up.



Numberpad



a. The numberpad is used to enter various parameters and values. The Clear key can be used to clear set parameters.

b. **F1/F2/F3/F4** function short cuts. Press any of the function short cuts when in the main menu to enter the corresponding function interface.

- F1: Basic power supply function
- F2: Digital voltmeter function
- F3: Pulse current meter function
- F4: Long integration current measurement function.

c. **H/L/A** Pulse current measurement shortcut keys. These short cut keys only work in the Pulse current measurement main menu.

- H: High measurement mode
- L: Low measurement mode
- A: Average measurement mode

Directional keys and Enter key

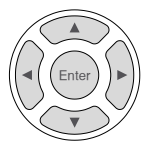

The directional keys are used for parameter and menu selection as well for fine adjustment of the current/voltage settings.

The Enter key is used to confirm the selection of any settings or parameters and to exit after a setting is complete.

Power Button

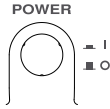

Turns the power on or off.

On: ■

Off: □

Terminals

Output
Terminals
(SOURCE)

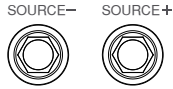

Output source terminals.

Voltage
Feedback
Terminals
(SENSE)



Sense terminals.

Voltmeter
Terminals
(DVM)

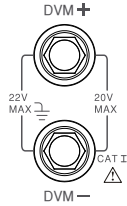

Digital voltmeter input
terminals.

Rear Panel

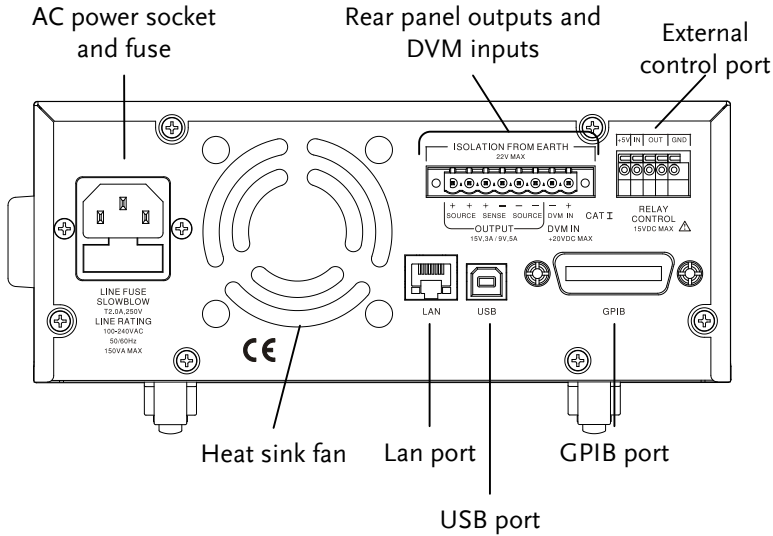

Terminals

AC input socket and line fuse

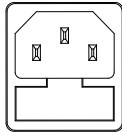

The AC input:
 90~264VAC, 50Hz/60Hz
 Fuse: 2A slow-blow type. See page [133](#) for details.

USB port



USB device port for remote control. See page [67](#) for details.

GPIB port



GPIB slave port for remote control. Abides to IEEE488.1 (SCPI) protocol. See page [69](#) for details.

LAN port



LAN port for remote control. See page [72](#) for details.

Output interface

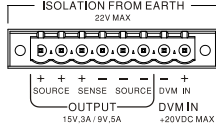

A total of 8 ports: 2 positive output terminals, 2 negative output terminals, a Sense+ terminal, a Sense- terminal, a DVM- input terminal and a DVM+ input terminal. Refer to the printed label under the terminals for the specific order of the terminals.

Relay control interface

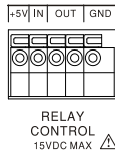

A total of 5 ports: A +5V input terminal, a ground terminal and 2 terminals for relay control. See page 56 for relay control details.

Constant Voltage/Constant Current Crossover Characteristics

Background The unit will switch automatically between constant voltage and constant current according to changes in the load.

CV mode When the load current is less than the current setting, the unit operates in constant voltage mode, changing the current level according to the load but maintaining the set voltage level until the current reaches the set current level. The status indicator will show CV on the LCD when in CV mode.

Constant Current Mode When the output current reaches the set current level, the unit switches operation to constant current mode. The status indicator will show CC on the LCD display. In CC mode, the current level is maintained and the voltage level is limited to less than the set voltage level to limit the output power from an overload. When the current drops below the set current level, the unit will revert back to CV mode.

Diagram

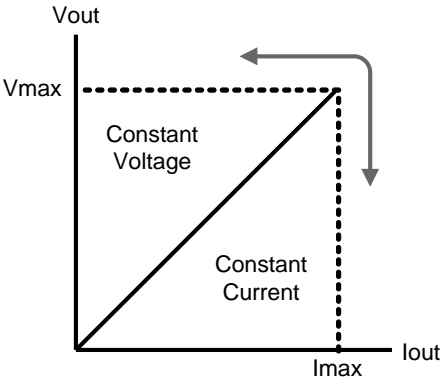

GETTING STARTED

This chapter describes the start up procedures and the preparation that is necessary before operating the power supply.

Start Up

Checking the AC Voltage

Before the power is turned on, confirm that the input power supply meets the following conditions:
90-264VAC, 50Hz/60Hz

LINE FUSE
SLOWBLOW
T2.0A,250V
LINE RATING
100-240VAC
50/60Hz
150VA MAX

Connecting the AC power cord

The fuse is a 2A slow-blow fuse. Confirm that the fuse is of the correct type and rating before connecting the power cord.

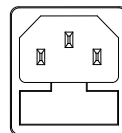

Turning the power on

Press the power button. The LCD will display the line frequency of the AC power supply.

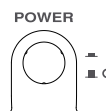

Turning the power off

To turn the power off, press the power button again.

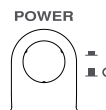

DVM and Load Connection

Recommended Cables	Model	Specification	Usage
	GTL-117	10A	Front panel DVM input
	GTL-204A	10A	Front panel Source terminal
	GTL-203A	3A	Front panel Sense terminal

Front panel wiring

Use the GTL-204A cables for the front panel source connections.

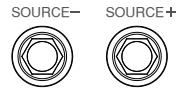

Use the GTL-203A cables for the sense connections.

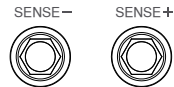

Use the GTL-117 cables for the DVM connections.

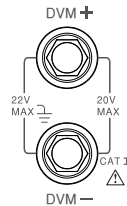

Rear panel connections

Rotate the screws counter clockwise to loosen the ports.

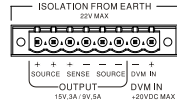

Insert the wires into the appropriate terminal according to the labels printed under the terminals.

Screw the terminals in a clockwise direction to tighten.



Note

For safety considerations, please keep in mind that the front panel and rear panel terminals are physically connected.

Wire Gauge

Load wires must have enough current capacity to minimize cable loss and load line impedance. Voltage drop across a wire should not exceed 0.5V. The following list is the wire current rating at 450A/cm².

Wire Size(AWG)	Maximum Current (A)
20	2.5
18	4
16	6
14	10
12	16

Turning the Output On/Off

Panel Operation

Press the *Output* key to turn the output on. The *Output* key will light-up when the output is on.

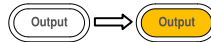

The status display on the LCD display will also turn on.



When the output is turned on, pressing the *Output* key again will turn the output off. When the output is off, the Output key will no longer be illuminated and the status on the LCD display will revert back to the OFF status.

Automatic
Output Shut
Down

Any of the following actions will cause the output to be automatically shut down:

- If any of the setups are recalled.
- OVP/OTP protection is tripped.
- OCP protection is tripped.

BASIC OPERATION

This chapter describes how to set various functions.

Basic Power Supply Functions

Description	The PPH-1503 operates as a generic power supply with the ability to display different current ranges. The output can be toggled between the front and rear outputs using the Rear key. When the Rear key is lit, it indicates that the rear panel output is active and that the front panel output is off.
-------------	--

Parameter Description	IntRate	<p>The data sampling period derived from the number of power line cycles.</p> <p>The setting range is: 0.1PLC to 10.00PLC (power line cycles)</p> <p>1PLC = 16.7ms(60Hz)/20ms(50Hz).</p> <p>*PLC stands for power line cycles.</p>
--------------------------	---------	--

AverRead[1][2] Readback refresh rate. This will display the average number count. The settings for parameters[1][2] are shared, the remaining parameters [3][4] are set in their corresponding menus.

[1] Power Supply functions

[2] DWM function.

[3] Pulse current measurement

[4] Long integration current measurement

CurrRange The current range selection has three settings: 5A, 5mA and Auto.

The 5mA range only accepts a current setting 1A or less. If the 5mA range is selected and if the current setting is greater than 1A, the setting value is automatically reduced to 1A.

LimMode	<p>Current limiting mode</p> <p>There are 4 settings for the current limiting mode:</p> <p>Limit, Trip, LimitRelay, Trip Relay.</p> <p>The Limit settings will limit the current. When the current reaches the setting value, the current remains constant, as in CC mode.</p> <p>The Trip setting will turn the output off when the current limit has been reached.</p> <p>See page 56 for details on the Limit Relay and Trip Relay settings.</p>
PowoOnSetup	<p>Power on settings have 11 settings:</p> <p>Rst/SAV0 ~ SAV9</p> <p>See page 60 for further details.</p>
RelayControl	<p>The relay control settings have 2 configurations:</p> <p>Zero/One</p> <p>See page 56 for further details.</p>
O.V.P	<p>The overvoltage settings have a setting range of 0.05 to 15.20V or OFF.</p>
RecallSetup	<p>There are 6 sets of save/recall memories.</p> <p>Rst/ SAV0 to SAV4</p>

Output Range	Voltage	0.000V~15.000V
	Current	0.0000A~3.0000A (0V~15V) 0.0000A~5.0000A (0V~9V)

Parameter Settings Voltage Press the *Voltage* key and the voltage setting on the LCD is activated. A yellow dot appears under the current digit.

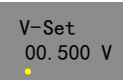

(a) Use the number pad (keys: 0~9, Clear) to set the voltage value and then press the *Enter* key.



To enter 12.345V:



The input dialog box appears on the LCD:



(b) Step Setting:

Press the left and right arrow keys () to fine tune the voltage setting at the digit level. The selected digit will have a yellow dot directly underneath. Press the up and down arrow keys () to adjust the selected digit. Press the *Voltage* key again to finish and exit setting the voltage.

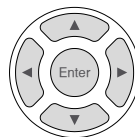

Current

Press the *Current* key and the current setting on the LCD is activated. A yellow dot appears under the current digit.



1-Set
2.000 A

(a) Use the number pad (keys: 0~9, Clear) to set the current value and then press the *Enter* key.

To enter 1.2345A:



The input dialog box appears on the LCD:



1.2345

Press the left and right arrow keys (←, →) to fine tune the current setting at the digit level. The selected digit will have a yellow dot directly underneath. Press the up and down arrow keys (↑, ↓) to adjust the selected digit. Press the *Current* key again to finish and exit setting the current.

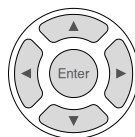

IntRate Use the arrow keys to select **IntRate** and press *Enter*. Input the parameters and press *Enter* to save.

Range: 0.1 to 10.00

AverRead[1][2] Use the arrow keys to select **AverRead[1][2]** and press *Enter*. Input the parameters and press *Enter* to save.

Range: 1 to 10

CurrRange Use the arrow keys to select **CurrRange** and press *Enter* to go to the CurrentRange menu. Input the current range using the up and down arrow keys. Press *Enter* to save.

LimMode Use the arrow keys to select **LimMode** and press *Enter* to go to the Current Lim menu. Select the Current Lim mode using the up and down arrow keys. Press *Enter* to save.

See page 56 for further details.

PowOnSetup Use the arrow keys to select **PowOnSetup** and press *Enter* to go to the Power On Setup menu. Use the up and down arrow keys to select the power on setting. Press *Enter* to save.

See page 60 for further details.

RelayControl Use the arrow keys to select **RelayControl** and press *Enter*. Use the up and down arrow keys to set the type of relay control. Press *Enter* to save.

See page 56 for further details.

O.V.P Use the arrow keys to select **O.V.P** and press *Enter*. Input the OVP setting and press *Enter* to save.

RecallSetup Use the arrow keys to select **RecallSetup** and press *Enter* to go to the Recall Setup menu. Use the arrow keys select a stored setup. Press *Enter* to confirm the recall.

See page 60 for further details.



Note:

1. The *Clear* key can be used to clear numbers that have already been entered.
2. Voltage and current parameter values use stepped input values. All other numerical parameters can use the number pad to enter parameter values.

Operation

REAR /
FRONT

After setting all the parameters the Rear key can be used to set the output to the front or rear output terminals.

Pressing the Rear key will toggle the output between the front and rear terminals.

When set to rear, the Rear key will light up and REAR will appear in the status bar on the LCD.

When set to front, the Rear key will not be lit and FRONT will appear in the status bar on the LCD.



Output Press the *Output* key to turn the output on. When the output is on, the Output key will light up and ON (in green) will be shown in the status bar on the LCD.

When the output is off, the Output key will not be lit and OFF (in red) will be shown in the status bar on the LCD.



Status Description

CV/CC

These two icons represent the output states of the power supply:



CV appears in yellow when the power supply is in constant voltage mode.

CC appears in red when the power supply is in constant current mode.

O.V.P

OVP will appear in yellow when the OVP has not been tripped.







The OVP icon will turn red when the OVP has tripped.











When the OVP protection has not been activated, it will be greyed-out.



BEEP	When the beeper setting is activated, the BEEP icon will be shown in yellow. 
	When the beeper settings is turned off, it will be greyed-out. 

LOCK	When the panel lock is activated, the lock icon will be shown in red. 
	When the panel lock is turned off, the lock icon is greyed-out. 

RMT	In the remote control display area, RMT will be shown in grey when reomote control is disabled. 
	When GPIB remote control is active, a red GPIB icon is shown. 
	When LAN remote control is active, a red LAN icon is shown. 
	When USB remote control is active, a red USB icon is shown. 

REAR/ FRONT	When the output is set for the rear panel terminals, REAR is displayed in yellow.	
	When the output is set for the front panel, FRONT is displayed in yellow.	
ON/OFF	When the output is off, OFF is displayed.	
	When the output is on, ON is displayed.	

DVM

Description	The PPH-1503 has a separate digital voltmeter with a measurement range of 0~+20VDC. When using the voltage meter, the power supply must be properly grounded.	
Parameter Description	Intrate	<p>Sets the reading rate of DVM measurements based on the number of PLCs.</p> <p>0.01PLC~10.00PLC.</p> <p>1PLC=16.7ms(60Hz)/20ms(50Hz).</p> <p>*PLC stands for Power Line Cycle</p>

AverRead[1][2]	The number of samples used to calculate the average. The AverRead setting for the power supply functions[1] and the DVM functions[2] are shared.
	<p>Note:</p> <p>[1]: Power supply functions</p> <p>[2]: DVM function</p> <p>[3]: Pulse current measurement function</p> <p>[4]: Long Integration current measurement function</p>
RecallSetup	There are 6 sets of save/recall memories. Rst/ SAV0 to SAV4
Parameter Settings	<p>IntRate Use the arrow keys to select IntRate and press <i>Enter</i>. Input the parameters and press <i>Enter</i> to save.</p> <p>Range: 0.01 to 10.00</p>
	<p>AverRead[1][2] Use the arrow keys to select AverRead[1][2] and press <i>Enter</i>. Input the parameters and press <i>Enter</i> to save.</p> <p>Range: 1 to 10</p>

Recall Setup	Use the arrow keys to select RecallSetup and press <i>Enter</i> . Use the arrow keys select a stored setup. Press <i>Enter</i> to confirm the recall. See page 60 for further details.
Operation	The unit switches to DWM mode automatically when the DVM inputs are used. Using the DVM meter function doesn't affect the operation of the power supply. The DMV function works with the output on or off.
Connection	For the connection details for the front and rear terminals, please page 28.

Pulse Current Measurement

Description	<p>Changes in the load current allows us to measure the pulse current.</p> <p>There are three ways that pulse current can be measured:</p> <ol style="list-style-type: none">1. Measuring the peak current over a single cycle (High Measurement).2. Measuring the trough current over a single cycle (Low Measurement).3. Measuring the average current over a single cycle (Average Measurement).
-------------	---

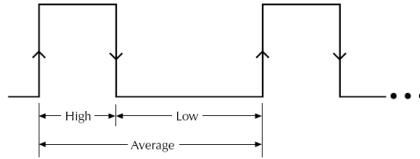

The high and average measurements are triggered by the rising edge of the pulse current and are performed for the time specified for the measurement.

Low measurement is triggered by the falling edge of the pulse current.



Note: Pulse current measurement is only valid up to 5A.

Parameter
Description

IntTime

- Integration Time.
- The integration measurement time can be set to automatic or to one of the manual settings (High Time, Low Time, Aver Time).
- When the integration measurement time is set to automatic mode, the system will measure the peaks and troughs of the pulse current and will automatically set an appropriate intergration time. The average integration time is the time of all the accumulated peaks and troughs. After the setting the integration time to automatic, the setting will apply to all subsequent pulse measurements, unless the automatic integration mode is applied again or the integration time is manully set. The automatic

Integration time can automatically detect pulses in the 80uS to 833mS range.

- The manual time range setting is 33uS to 833333uS. The default units are in microseconds (uS). The unit will automatically round down the last two digits to 00, 33 or 66 microseconds. For example, for a value of 65.999, it will be rounded down to 33 and 66.01 will be rounded down to 66.

TrigDelay

- Trigger Delay
- When a pulse is detected, there will be a 25us code execution delay time. The trigger delay settings are used to filter out the current overshoot. Measurement will begin from after the trigger delay time. The trigger delay setting range is: 0~0.10000S, with a resolution of 0.00001S. The setting units are in seconds.

AverRead[3]

- Average Reading Count: Reads back the average number of displayed values.
- This parameter is only applicable for pulse current measurement. The average number range can set from 1 ~ 100 with a resolution of 1.



- TrigLeve[3]
 - Trigger Level.
 - To avoid false pulse measurements, the trigger level can be set close to the current amplitude. All noise and transient currents that are below the trigger level will be ignored. The trigger level has a setting range of 0 to 5A, with a resolution of 5mA. The setting unit for the trigger level is in amps (A). This setting is only valid for pulse measurements.

- RecallSetup Recalls stored settings. A total of 6 settings can be recalled:

RST/SAV0 to SAV4

Parameter Settings	IntTime	<p>Use the arrow keys to select IntTime, press <i>Enter</i> and then use the arrow keys to select the type of integration time that you want to set (Hight Time, Low Time, Aver Time). Press <i>Enter</i> again to set the integration time. After inputing the integration time, press <i>Enter</i> to return to the pulse current measurement menu. If Auto Time was selected, press <i>Enter</i> to return to the pulse current measurement menu.</p>
--------------------	---------	--

Example:

High Time 33uS: **IntTime** ⇨  ⇨ **Hight Time** ⇨  ⇨ using the

numberpad enter 33 \Rightarrow .

The time range can be set between 33uS and 833333uS. The setting units are in microseconds (uS).

TrigDelay Use the arrow keys to select **TrigDelay**, press *Enter* and input the delay. Press *Enter* again to confirm.

The TrigDelay has a settable range of 0~0.10000S. The setting units are in seconds (S).

AverRead[3] Use the arrow keys to select **AverRead[3]**, and then press *Enter*. Input the AverRead number and then press *Enter* again to confirm.

The AverRead setting has a settable range of 1~00.

TrigLeve[3] Use the arrow keys to select **TrigLeve[3]** and press *Enter*. Input the trigger level and press *Enter* again to confirm.

The TrigLeve parameter has a settable range of 0~5.000A. The setting units are in amperes (A).

RecallSetup Use the arrow keys to select **RecallSetup** and press *Enter* to go the Recall Setup menu. Use the arrow keys to a setup. Press the *Enter* key to confirm. See page 60 for further details.

Panel Operation Output

Press the *Output* key.
When the Output key is lit, pulse current measurement is active.



When no pulse current is detected, NO PULSE will be displayed in red on the LCD screen. The unit will wait until the next pulse is detected.



The measurement settings can be edited during measurement. The H, L, A keys on the keypad can be used to perform fast-switching between measurement modes.

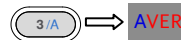
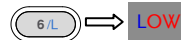
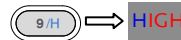

Note

The LCD display will indicate which measurement mode is active with an orange line under the active mode for HIGH, LOW or AVER.

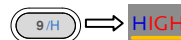

Long integration

Description

The long current integration measurement function measures the mean (average) current over a single or multiple current pulses. The long integration time period must be a full period or integer multiples of a complete period of the measured pulse current. The Long integration measurement calculates the whole integration time as an integer number of integration cycles. An integration cycle is the line cycle period plus the data processing time.

For example, if the line frequency is 60Hz, then a single integration cycle is 16.7mS, if the frequency is 50Hz, then a single integration cycle is must be 20mS. Long integraton is one of the methods to extend A/D circuits to exceed beyond their maximum integration time. The A /D conversion circuits can measure a pulse of up to 833 mS. Long integration measurement extends the A/D integration time to achieve a longer pulse measurement. This can extend the measurement time for long integration to a maximum of 60S.



Note: When this feature is used, the current range is set to 5A.

Parameter Description	IntTime	<ul style="list-style-type: none">• Integration time• The integration time can be set manually or automatically by the operator. For manual settings, the integration time can be set to a maximum of 60 seconds. For a line frequency of 60Hz the minimum integration time is 850mS with a step resolution of 16.7mS. For a line frequency of 50Hz, the minimum integration time is 840mS with a step resolution of 20mS.• When the integration time is set to Auto Time, the system will automatically measure the time between two adjacent rising edges and an appropriate integration time is set for the peak and trough. If there are more than two pulses, the integration time must be set manually.
	TrigEdge	<ul style="list-style-type: none">• Trigger edge• Pulse edges are used to trigger long integration measurement. Regardless of whether a rising or falling edge is used as a trigger, a pulse must first be detected before measurement can start. Measurement can also start without an edge trigger. When Trig On Neither is selected, measurement starts as soon as the output is turned on.

- Timeout
- Pulse timeout
 - When long integration measurement is selected and the unit doesn't detect a pulse after a certain amount of time (pulse timeout time), the "No Pulse" message will be displayed on the LCD. This function is only applicable if rising or falling edge is selected as the edge trigger; the Trig On Neither trigger setting has no pulse timeout. The pulse timeout has a range of 1~63 seconds.
- TrigLeve[4]
- Trigger level.
 - When the rising or falling edge trigger is selected for long integration current measurement, a pulse must first be detected. The trigger level refers to minimum pulse level required for a pulse to be detected. For example if the trigger level is set to 2A, pulses that are $\leq 2A$ will be detected. Pulses $< 2A$ will be ignored. The trigger level range is 0~5A. This setting only applies to long current integration measurements.
- RecallSetup
- Recalls pre-saved setups. A total of 6 setups can be recalled: RST/SAV0 ~ SAV4. See page 60 for details.

Parameter Settings	IntTime	<p>Use the arrow keys to select IntTime then press <i>Enter</i>. Use the arrow keys to select a time setting.</p> <p>If SetTime was selected, press <i>Enter</i> and then enter the long current integration time. Press <i>Enter</i> to save the setting and return to the long integration measurement menu.</p> <p>If AutoTime was selected, press <i>Enter</i> to confirm and to go back to the long integration measurement menu.</p> <p>For manually set integration times, if the set time is not an integer multiple of the integration cycle time, the system will automatically round down to closest maximum integer multiple that can be set. The time range is 850mS to 60S (50Hz) and 840mS to 60S (60Hz). The default unit is seconds (S).</p>
	TrigEdge	<p>Use the arrow keys to select TrigEdge and then press <i>Enter</i>. Use the arrow keys to select the type of trigger and press <i>Enter</i> to confirm the trigger settings and to return to the long integration measurement menu.</p>
	Timeout	<p>Use the arrow keys to select Timeout and then press <i>Enter</i>. Enter the timeout settings and press <i>Enter</i> again to confirm and to return back to the long integration measurement menu. The time range is 1~63S. The default unit is seconds (S).</p>

TrigLeve[4] Use the arrow keys to select **TrigLeve[4]** and then press *Enter*. Key in te trigger level setting and press *Enter* again to confirm and to return back to the long integration measurement menu. The trigger level range is 0~5A. The default is amps (A.)

RecallSetup Use the arrow keys to select **RecallSetup** and press *Enter* to go to the Recall Setup menu. Use the arrow keys to select a saved setup and press *Enter* again to confirm. See page 60 for details.

Operation

Output

Press the *Output* key. When the *Output* key is lit, pulse current measurement is active.



When no pulse current is detected, NO PULSE will be dispalyed in red on the LCD screen. The unit will wait until the next pulse is detected.

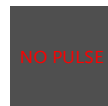

Current Sink Function

Function Description When the test circuit is an active circuit, and the manifested voltage in the test circuit is greater than the output voltage of the power supply, the power supply will automatically disipate current from the external power supply. When this function is in the normal operating state, the power supply outputs the setting voltage, which is equivalent to a constant voltage load rather than constant current load.

The current disipation from the power supply output flows from the positive terminal out to the negative terminal. The amount of current sunk is not controlled from the power supply.

Connection Connect the positive terminal of the external power supply to the positive terminal on the high-speed power supply. Connect the negative terminal of the external power supply to the negative terminal on the high-speed power supply.

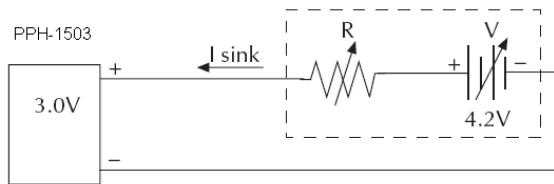

Conditions To protect the high-speed power supply when operating as a current sink, the following two conditions must be met:

1. Ensure that the voltage of the external power supply is greater than the output of the high-speed power supply voltage by 0.3V~2.5V. The voltage difference depends on the high-speed power supply voltage output and the load conditions.
2. To ensure that the high-speed power supply output voltage is within the range of 0~5V, the current draw cannot exceed 2A. For output voltages between 5V~15V, the current draw must be reduced by 0.1A for each 1V increase over 5V. See the formula in the table below for the details.

High-speed Power Supply Output Voltage	Maximum Dissipation Current
0~5V	2A
5V~15V	$2A - ((0.1A/V) * (\text{output voltage} - 5V))$

External Relay Control

Function Description When the Relay control feature is turned on, it is synced to the current limit of the power supply. The external relay control is divided into two different types, a limit relay and a trip relay.

The limit relay is used in conjunction with CC mode. When the constant current setting value is reached, the relay control signal will go high and will return back to the low level when the current level goes back below the constant current setting.

The trigger relay is used in conjunction with CC mode. When the constant current setting value is reached, the relay control signal will go high and the output is disabled. When the output goes back on and the current is less than the current setting value, the relay control signal will back to the low level.

Rear Panel Control Interface The rear panel control interface has five terminals, +5V, IN (software upgrade), OUT (outputs the control signals) and GND (connected to the chassis ground or earth ground), respectively.

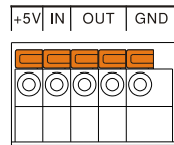

Wiring Method A thin screwdriver or similar tool will need to be inserted into the release mechanism (highlighted in orange in the figure above) to open the terminals. Insert an exposed wire into the terminal and release the mechanism to lock the wire into place.

Schematic
Diagram for Relay
Control

Limit Relay:

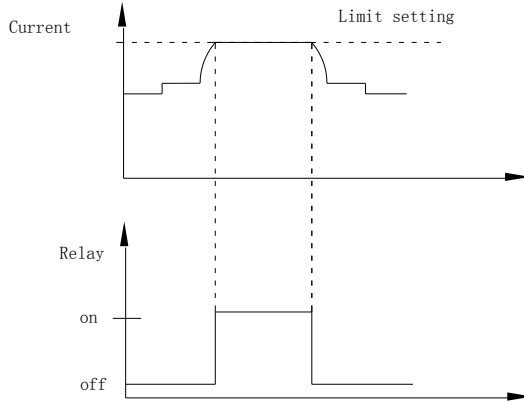

Trip Relay:

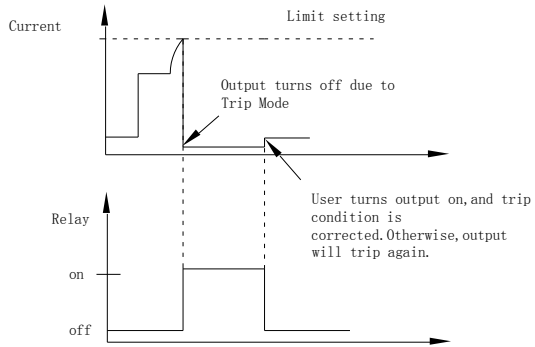

External Relay Connection

There are two ways to connect an external relay to the unit:

1. Using the the +5VDC relay output to drive an external relay. Ensure the current doesn't exceed 150mA.

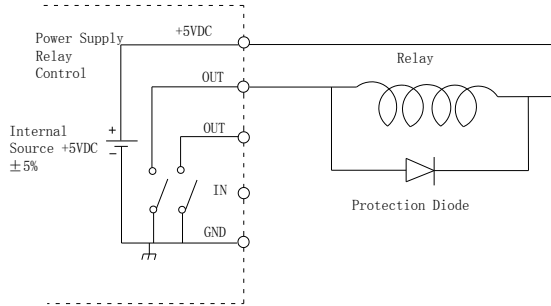

Warning: Do not short the 5VDC terminal to the chassis, earth or to the control port GND, otherwise it may damage the unit.



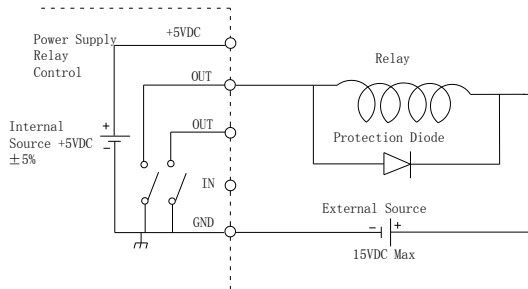

2. Using an external power source to drive the external relay. The voltage of the source cannot exceed 15V and the current cannot exceed 150mA.



SAVE/RECALL

Save Settings

Description	Five groups of system settings are available.																																												
Parameter data	Listed below are the settings that are available for each group (Rst is shown as an example).																																												
	<table border="1"> <tr> <td>Voltage:</td> <td>00.500V</td> <td>CurrRange:</td> <td>5A</td> </tr> <tr> <td>Current:</td> <td>2.0000A</td> <td>IntRate:</td> <td>1.00PLC</td> </tr> <tr> <td>OutputState:</td> <td>Off</td> <td>AverRead[1][2]:</td> <td>1</td> </tr> <tr> <td>DispType:</td> <td>Actual V and I</td> <td>O.V.P:</td> <td>Off</td> </tr> <tr> <td>GPiBAddr:</td> <td>16</td> <td>LimMode:</td> <td>Limit</td> </tr> <tr> <td>GPiBFormat:</td> <td>Exponential</td> <td>RelayControl:</td> <td>Zero</td> </tr> <tr> <td>HighTime:</td> <td>33us</td> <td>AverRead[3]:</td> <td>1</td> </tr> <tr> <td>LowTime:</td> <td>33us</td> <td>TrigDelay:</td> <td>0.10000</td> </tr> <tr> <td>AverTime:</td> <td>33us</td> <td>TrigLevel[3]:</td> <td>0.000A</td> </tr> <tr> <td>IntTime:</td> <td>1.000s</td> <td>TrigEdge:</td> <td>Rising</td> </tr> <tr> <td>Timeout:</td> <td>16s</td> <td>TrigLevel[4]:</td> <td>0.000A</td> </tr> </table>	Voltage:	00.500V	CurrRange:	5A	Current:	2.0000A	IntRate:	1.00PLC	OutputState:	Off	AverRead[1][2]:	1	DispType:	Actual V and I	O.V.P:	Off	GPiBAddr:	16	LimMode:	Limit	GPiBFormat:	Exponential	RelayControl:	Zero	HighTime:	33us	AverRead[3]:	1	LowTime:	33us	TrigDelay:	0.10000	AverTime:	33us	TrigLevel[3]:	0.000A	IntTime:	1.000s	TrigEdge:	Rising	Timeout:	16s	TrigLevel[4]:	0.000A
Voltage:	00.500V	CurrRange:	5A																																										
Current:	2.0000A	IntRate:	1.00PLC																																										
OutputState:	Off	AverRead[1][2]:	1																																										
DispType:	Actual V and I	O.V.P:	Off																																										
GPiBAddr:	16	LimMode:	Limit																																										
GPiBFormat:	Exponential	RelayControl:	Zero																																										
HighTime:	33us	AverRead[3]:	1																																										
LowTime:	33us	TrigDelay:	0.10000																																										
AverTime:	33us	TrigLevel[3]:	0.000A																																										
IntTime:	1.000s	TrigEdge:	Rising																																										
Timeout:	16s	TrigLevel[4]:	0.000A																																										

- Operation
- Press the Menu key to enter the main menu interface. 
- Use the up and down arrow to select the **Save Setup** option.  
- Press Enter to go to the Save Setup menu. 

Use the left and right arrow keys to select the desired save memory. There are five selections: SAV0, SAV1, SAV2, SAV3, SAV4.



Press the Enter key to save the settings and return to the main interface.



Result The current settings on the unit will be saved to one of the memory locations (SAV0~SAV4)

Recall Settings

Description There a total of 6 different memory settings that can be recalled: Rst, SAV0, SAV1, SAV2, SAV3, SAV4, SAV5.

Operation There are two methods to recall the setup settings.

Method 1:

Use the arrow keys to select **Recall Setup** via F1, F2, F3 or F4 from the display interface



Press the *Enter* key to enter the Recall Setup interface.



Use the left and right arrow keys to select a setup to recall (Rst, SAV0 ~ SAV4).



Press *Enter* to confirm and to return to the main interface.



Method 2:

Press the *Menu* key



Use the up/down arrow keys to select **Recall Setup**.



Press *Enter* to enter the Recall Setup interface.



Use the left and right arrow keys to select which setting to recall.



Press the *Enter* key to confirm the selection.



Power On
Settings

In the main menu, the interface parameter settings area shows **PowOnSetup** settings. There are 11 **PowOnSetup** settings to choose from, Rst, SAV0~SAV4 and SAV5~SAV9.

The main difference between SAV0~SAV4 and SAV5~SAV9 is that SAV0~SAV4 are user saved settings and don't contain the Power On/Off state (**Output State** is always off) while the SAV5~SAV9 contain the Power On/Off state. The SAV5~SAV9 settings are synced from corresponding SAV0~SAV4 settings and are identical but for the the Power On/Off state. The Power On/Off states simply indicate if the **Output State** can be on or off.

The relationship between SAV0~SAV4 and SAV5~SAV9 is as follows:

SAV0 ⇔ SAV5

SAV1 ⇔ SAV6

SAV2⇔SAV7

SAV3⇔SAV8

SAV4⇔SAV9

Restore Factory Default Settings

Description	The system can retrieve the factory default settings by loading the Rst setting. This setting cannot be modified.
-------------	---

Operation	There are two methods to retrieve the factory default settings. Please see the Recall Settings sections for instructions (page 60).
-----------	---

S SYSTEM SETTINGS

System Information

Description	The System Information menu can be used to view the system information or to perform system operations such as set the buzzer function, backlight display brightness or set to the factory conditions.
-------------	--

System Information Items	System Version	View the system software version.
	Serial Number	View the machine serial number.
	Calibration Unit	Calibration menu. Factory use only.
	Utility	System setting items: Buzzer settings, backlight brightness settings and factory restore.

Operation	Press the Menu key and select System Information . Press the Enter key to enter the System Information menu.
-----------	---

Utility Settings

Description There are two utility settings: buzzer settings and backlight brightness settings.

Setting Information	<table border="0"> <tr> <td style="padding-right: 20px;">Beep</td> <td>Sets the when the buzzer is turn on.</td> </tr> <tr> <td>BackLight</td> <td>Adjust the LCD brightness.</td> </tr> </table>	Beep	Sets the when the buzzer is turn on.	BackLight	Adjust the LCD brightness.
Beep	Sets the when the buzzer is turn on.				
BackLight	Adjust the LCD brightness.				



Buzzer Operation In the *Utility* menu, use the up and down arrows to select **Beep**.

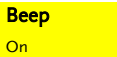

Press *Enter* and then set the buzzer state to on or off. When the buzzer is set to on, Beep On will be displayed.



Press the *Menu* key to exit and return to the main interface. The buzzer status will be displayed on the LCD.

Backlight Brightness Adjustment In the *Utility* menu, use the up and down arrow keys to select **BackLight**.



Press *Enter* to toggle the backlight brightness level. The brightness level is displayed under **BackLight**. There are three brightness levels: High, Middle, Low.

Press the *Menu* key to exit and return to the main interface.



Restore to Factory Settings In the *Utility* menu, use the up and down arrow keys to select **In factory reset**, then press the *Enter* key to restore to the factory settings. This function is only for factory use.

REMOTE CONTROL

Remote Control

USB

Description	The PPH-1503 can be connected via USB using the USB Communications Device (CDC) class.
-------------	--

Interface	Rear panel USB slave port.
-----------	----------------------------

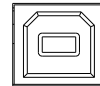

Installing the Driver	<p>Before connecting the unit to the USB port of the PC, make sure the appropriate driver has been installed. The driver is available from the GW Instek website. When the unit has successfully connected to the PC via USB, USB will be displayed in the status bar in red.</p>
-----------------------	---



<p>The front panel keys are automatically locked when the unit is in remote mode.</p>



COM port settings

The following settings should be set to the following:

- Baud rate: 115200 or less
 - Parity: None
 - Data bits: 8
 - Stop bits: 1
 - Data overflow control: None
-

Function Check

Perform the following query:

*IDN?

The unit will return the manufacturer, model, serial number and software version.

GW INSTEK, PPH-1503, SN: xxxxxxxx, Vx.xx

Disabling Remote Control Mode

- Send a remote command to exit from remote control mode from the PC or long-press the unlock key on the front panel to exit from the remote control mode. The RMT icon in the status bar will become grey when you exit from remote control mode.
- The LOCK icon in the status bar will also turn grey.
- Unplug the USB cable from the rear panel.





Note: USB devices are hot-plug devices. You can directly remove the cable and exit.

GPIB







Description The GPIB remote control can be set from the interface menu. The communication data format, compatibility settings and address must all be configured before using GPIB remote control.

Interface Rear panel GPIB port. 

Connection When the unit has been successfully connected via GPIB, GPIB will appear in the status bar in red. The panel key will also be locked. 

The front panel keys are automatically locked when the unit is in remote mode. 

Communication Data Format There are four data formats to select from: Exponential, 2DPS, 3DPS and 4DPS.

- Steps**
- A. Press the *Menu* key to enter the main menu. 
 - B. Use the up and down arrow keys to select **Interface**.  
 - C. Press *Enter* to enter the Interface menu. 
 - D. Use the up and down arrow keys to select **GPIB**.  
 - E. Press *Enter* to enter the GPIB menu. 

F. Use the up and down arrows to select **Output Format**.



G. Press the *Enter* key to toggle between the different output formats.



H. Press the *Menu* key to exit and return to the main menu.



Output Formats There are two different output formats to select from: KEITHLEY 2303 and FLUKE PM2811.

Steps Follow steps A~E in the previous section, above.

F. Use the up and down arrow keys to select **Output Type**.



G. Press the *Enter* key to toggle between each of the output formats.



H. Press the *Menu* key to exit and return to the main menu.



Setting the GPIB Address Configuring the GPIB address for connection to a PC.

Steps Follow steps A~E in the previous section, above.

F. Use the up and down arrow keys to select **Primary Address**.



G. Press the Enter key and then set the GPIB address. Press the Enter key again to confirm. The address range is 1~30.



H. Press the *Menu* key to exit and return to the main menu.



Exiting from Remote Control Mode













- Send a remote command to exit from remote control mode from the PC or long-press the unlock key on the front panel to exit from the remote control mode. The RMT icon in the status bar will become greyed-out when you exit from remote control mode.
- The LOCK icon becomes greyed-out when the panel becomes unlocked.
- Unplug the connection from the rear panel.



LAN

Description When using the LAN interface a number of settings must be turned on.

IP Mode The IP address can be configured using either DHCP, Auto IP or Manual IP. Using DHCP to get an IP address automatically assigned. The system will use AUTO IP to obtain an automatically generated IP address to avoid IP address conflicts.

- Manu IP**
- A. Press *Menu* to enter the main menu. 
- B. Use the up and down arrow keys to select **Interface**.  
- C. Press *Enter* to enter the Interface menu. 
- D. Use the up and down arrow key to select **LAN**.  
- E. Press *Enter* to enter the LAN menu. 
- F. Use the up and down arrow keys to select **IP Mode**.  
- G. Press *Enter* to select **Manu IP**. 
- H. Use the up and down arrow key to select the appropriate parameters.  
- I. Press *Enter* and then configure each of the parameters. 

J. Press *Enter* to confirm each of the configurations.



K. Press the *Menu* key to exit and return to the main menu.



Parameter Settings:

IP Address: IP address range: 1.0.0.0 to 223.255.255.255 (excluding 127.nnn.nnn.nnn).

Subnet Mask: Subnet Mask Range: 1.0.0.0 to 255.255.255.255.

Gateway: Gateway range: 1.0.0.0 to 223.255.255.255 (excluding 127.nnn.nnn.nnn).

DNS Servers: DNS Server range: 1.0.0.0 to 223.255.255.255 (excluding 127.nnn.nnn.nnn).

DHCP

Follow steps A~F in the previous section, Manun IP, above.

G. Press *Enter* to select **DHCP**. The unit will be assigned an IP address, subnet mask, the default gateway and other network parameters from the DHCP server. The corresponding parameters will be shown in the parameter area. Use the arrow keys to view the settings (When an IP address is being assigned, a circular scanning icon will appear).



H. Press the *Menu* key to exit and return to the main menu.



Auto IP

Follow steps A~F in the previous section, Manu IP, above.

G. Press the *Enter* key and select **Auto IP**. The device will automatically obtain an IP address and subnet address mask based on the current network configuration. The unit will set the IP address in the range of 169.254.0.1 to 169.254.255.254 with a subnet of 255.255.0.0. The parameters will be displayed in the parameter area. Use the arrow keys to view the parameters.



H. Press the *Menu* key to exit and return to the main menu.



PC Operation

1. Enter the IP address into Microsoft Internet Explorer (IE). After entering the IP address you will be shown the Welcome screen which displays the instrument information. The page also provides three links: Welcome Page, Browser Web Control and View & Modify Configuration (network settings).

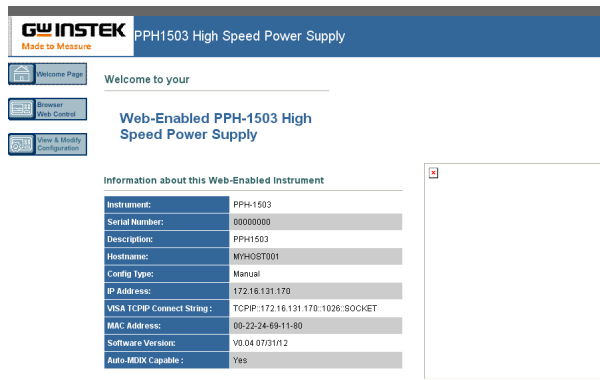

Use the navigation bar on the left to access your PPH-1503 High Speed Power Supply and related information.

2. Click on “Browser Web Control” to execute commands through the browser, as shown below.

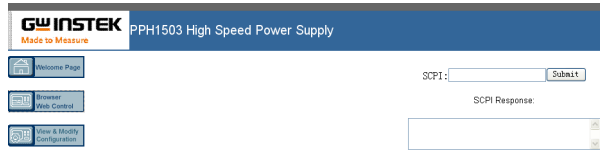

3. Press the “View & Modify Configuration” icon to enter the Modify Config menu, as shown below.

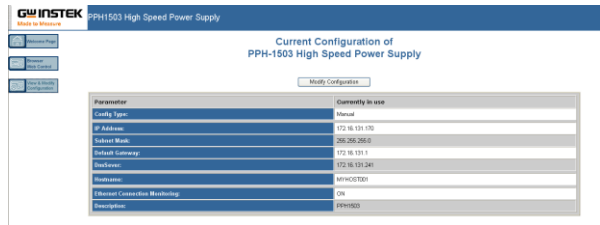

4. Click “Modify Config” to enter the network configuration setting menu, as shown below. Use the mouse to click on “Save and Restart” to change the remote settings for the PPH-1503.

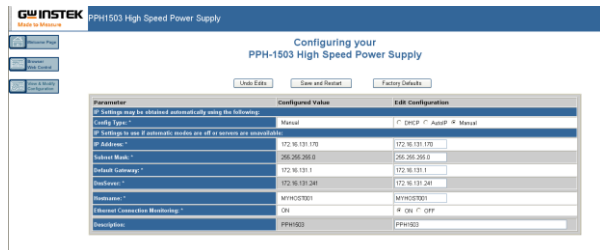



Note

Click “Undo Edits” to cancel all the edited settings.

Click “Factory Defaults” to restore to the factory default settings.

Exiting from Remote Control Mode

- Send a remote command to exit from remote control mode from the PC or long-press the unlock key on the front panel to exit from the remote control mode. The RMT icon in the status bar will become greyed-out when you exit from remote control mode.
- The LOCK icon will be greyed-out when the panel lock is disabled.
- Unplug the connection from the rear panel.



Note: Hot-swappable LAN devices can be directly disconnected to exit.

Command Syntax

The commands that are used with the PPH-1503 meet IEEE488.2 and SCPI standards.

SCPI Commands Overview SCPI

Command Format

SCPI is an ASCII based command language designed for test and measurement instruments. SCPI commands uses a hierarchical structure (tree system), and is divided into different subsystems. Each subsystem

is defined by a different root keyword. Each command consists of a root keyword and one or more hierarchical key words separated by a colon ":" and followed by a parameter. There is always a space between the keywords and the parameters. Any commands followed by a question mark (?) are queries.

For Example:

```
:SYSTem:BEEPer:STATe {0|1|OFF|ON}
```

```
:SYSTem:BEEPer:STATe?
```

SYSTem is the root level keyword and BEEPer and STATe are the secondary and tertiary level keywords. All all levels have a ":" separating each keyword. Parameters are enclosed in "{ }".

The commands SYSTem:BEEPer:STATe has {0|1|OFF|ON } as parameters. The parameters are separated with a space.

SYSTem:BEEPer:STATe? Indicates that the command is a query.

In addition some commands have multiple parameters that are usually separated by a comma ",". For example: :STATus:QUEue:ENABLE (-110:-222, -220).

Symbol Description

SCPI commands have the following conventional symbols. These symbols are not commands but are used to describe the command parameters.

1. Curly Brackets { }

Curly Bracket enclose command string parameters, for example:

```
{ OFF | ON }
```

2. Vertical Bars

Vertical bars are used to separate one or more optional parameters. Only one command can be selected; With the following two parameters, {ON | OFF} only ON or OFF can be selected.

3. Square Brackets []

The contents inside square brackets represent keywords or parameters that can be omitted when executing a command. For example: For the commands :OUTPut[:STATe] {ON | OFF}, [STATe] can be omitted.

4. Angle Brackets

The parameters in angle brackets must be substituted with a valid parameter. For example: For the command :DISPlay: CONTRast <brightness>, <brightness> must be use a numerical value instead such as, :DISPlay:CONTRast 1

Parameter Types

The commands have a number of different parameter categories. How the parameters are set depend on the parameter categories.

1. Boolean

Commands parameter that have to states "OFF" and "ON", for example, DISPlay:FOCUs {ON | OFF}. "ON" will turn on the focus display function, while "OFF" will turn it off.

2. Consectutive Integers

Parameters that use consecutive integers, for example: For the command `:DISPlay:CONTRast <brightness>`, `<brightness>` is an integer value with a range of 1~3.

3. Continuous Real Number

Parameter that must be a continuous real number can have any value within the effective range and accuracy. For example: The command `CURRent {<current> | MINimum | MAXimum}`, is used to set the current value for the current operating channel. `<current>` can be any value within the setting range of the current channel.

4. Discrete

For discrete parameters, only those values that are listed can be used. For example: The `*RCL{0|1|2|3|4|5}` command can only use 0, 1, 2, 3, 4, 5.

5. ASCII Strings

ASCII string parameters must use a combination of ASCII characters in a string. For example: For the command `:MODE <name>`, `<name>` must be an ASCII string.

Command Abbreviations

The syntax for SCPI commands contain a combination of upper and lower case letters. The upper case letters in a command represent the short form of that command.

Commands are not case sensitive and can used in both upper and lower case. Note, however, to use the short form of the command, only the capital letter part of the command can be used (no other abbreviation can be used). For example:

:MEASure:CURRent?

Can be abbreviated to:

:MEAS:CURR

Command Terminators

When sending a command to the function generator, the command must be terminated with a <new line> character. The IEEE-4888 EOI can also be used as a <new line> character. A command can also be terminated using a carriage return + <new line> character. The command path will always be reset back to the root level after a command has been terminated.

Return values are terminated with 0x0A.

Command List

Measurement Instructions

:FETCh?	Page 86
:FETCh:ARRay?	Page 86
:READ?	Page 86
:READ:ARRay?	Page 86
:MEASure[:<function>]?	Page 87
:MEASure:ARRay[:<function>]?	Page 87

Display Functions

:DISPlay:ENABle 	Page 88
:DISPlay:ENABle?	Page 88
:DISPlay[:WINDow[1]]:TEXT:STATe 	Page 88
:DISPlay[:WINDow[1]]:TEXT:STATe?	Page 89
:DISPlay[:WINDow[1]]:TEXT:DATA <a>	Page 89

:DISPlay[:WINDow[1]]:TEXT:DATA?	Page 89
DISPlay:CONTRast<NRf>	Page 89

Data Format Commands

:FORMat[:DATA] <type>	Page 90
:FORMat[:DATA]?	Page 90
:FORMat:BORDER <name>	Page 90
:FORMat:BORDER?	Page 90

Output Commands

:OUTPut[:STATe] 	Page 91
:OUTPut[:STATe]?	Page 91
:OUTPut:RELAy <name>	Page 91
:OUTPut:RELAy?	Page 91
:OUTPut:OVP:STATe 	Page 92
:OUTPut:OVP:STATe?	Page 92
:OUTPut:OVP <value>	Page 92
:OUTPut:OVP?	Page 92

Source Commands

:[SOURce]:CURRent[:LIMit][:VALue] <NRf>	Page 93
:[SOURce]:CURRent[:LIMit][:VALue]?	Page 93
:[SOURce]:CURRent[:LIMit]:TYPE <name>	Page 93
:[SOURce]:CURRent[:LIMit]:TYPE?	Page 94
:[SOURce]:CURRent[:LIMit]:STATe?	Page 94
:[SOURce]:VOLTage[:LEVel][:IMMEdiate][:AMPLitude] <n>	Page 94
:[SOURce]:VOLTage[:LEVel][:IMMEdiate][:AMPLitude]?	Page 94

Readback Commands

:SENSe[1]:FUNctIon <name>	Page 95
:SENSe[1]:FUNctIon?	Page 95
:SENSe[1]:NPLCycles <n>	Page 95
:SENSe[1]:NPLCycles?	Page 95
:SENSe[1]:AVERage <NRf>	Page 96
:SENSe[1]:AVERage?	Page 96
:SENSe[1]:CURRent[:DC]:RANGe[:UPPer] <n>	Page 96
:SENSe[1]:CURRent[:DC]:RANGe[:UPPer]?	Page 96
:SENSe[1]:CURRent[:DC]:RANGe:AUTO 	Page 97
:SENSe[1]:CURRent[:DC]:RANGe:AUTO?	Page 97
:SENSe[1]:PCURrent:AVERage <NRf>	Page 97
:SENSe[1]:PCURrent:AVERage?	Page 98
:SENSe[1]:PCURrent:MODE <name>	Page 98
:SENSe[1]:PCURrent:MODE?	Page 98
:SENSe[1]:PCURrent:TIME:AUTO	Page 98
:SENSe[1]:PCURrent:TIME:HIGH <NRf>	Page 99
:SENSe[1]:PCURrent:TIME:HIGH?	Page 99
:SENSe[1]:PCURrent:TIME:LOW <NRf>	Page 99
:SENSe[1]:PCURrent:TIME:LOW?	Page 99
:SENSe[1]:PCURrent:TIME:AVERage <NRf>	Page 100
:SENSe[1]:PCURrent:TIME:AVERage?	Page 100
:SENSe[1]:PCURrent:SYNChronize[:STATe] 	Page 100
:SENSe[1]:PCURrent:SYNChronize[:STATe]?	Page 101
:SENSe[1]:PCURrent:SYNChronize:DELay <NRf>	Page 101
:SENSe[1]:PCURrent:SYNChronize:DELay?	Page 101
:SENSe[1]:PCURrent:SYNChronize:TLEVel<NRf>	Page 101
:SENSe[1]:PCURrent:SYNChronize:TLEVel?	Page 102

:SENSe[1]:LINTegration:TIME <Nrf>	Page 102
:SENSe[1]:LINTegration:TIME?	Page 102
:SENSe[1]:LINTegration:TIME:AUTO	Page 102
:SENSe[1]:LINTegration:TLEVel <Nrf>	Page 102
:SENSe[1]:LINTegration:TLEVel?	Page 103
:SENSe[1]:LINTegration:TEDGE <name>	Page 103
:SENSe[1]:LINTegration:TEDGE?	Page 103
:SENSe[1]:LINTegration:TimeOUT <Nrf>	Page 103
:SENSe[1]:LINTegration:TimeOUT?	Page 104
:SENSe[1]:LINTegration:SEARCh 	Page 104
:SENSe[1]:LINTegration:SEARCh?	Page 104
:SENSe[1]:LINTegration:FAST 	Page 104
:SENSe[1]:LINTegration:FAST?	Page 105

Status Commands

:STATus:PRESet	Page 105
:STATus:OPERation[:EVENT]?	Page 105
:STATus:OPERation:CONDition?	Page 105
:STATus:OPERation:ENABLE <Nrf>	Page 106
:STATus:OPERation:ENABLE?	Page 106
:STATus:MEASurement[:EVENT]?	Page 106
:STATus:MEASurement:ENABLE <Nrf>	Page 106
:STATus:MEASurement:ENABLE?	Page 107
:STATus:MEASurement:CONDition?	Page 107
:STATus:QUEStionable[:EVENT]?	Page 107
:STATus:QUEStionable:CONDition?	Page 107
:STATus:QUEStionable:ENABLE <Nrf>	Page 108

:STATus:QUEStionable:ENABLE?	Page 108
:STATus:QUEue[:NEXT]?	Page 108
:STATus:QUEue:ENABLE <list>	Page 108
:STATus:QUEue:ENABLE?	Page 109
:STATus:QUEue:DISable <list>	Page 109
:STATus:QUEue:DISable?	Page 110
:STATus:QUEue:CLEar	Page 110

System Commands

:SYSTem:LOCal	Page 117
:SYSTem:REMOte	Page 116
:SYSTem:COMMunicate:LAN:DHCP[:STATe] 	Page 112
:SYSTem:COMMunicate:LAN:DHCP[:STATe]?	Page 112
:SYSTem:COMMunicate:LAN:IPAdDress <IP address>	Page 113
:SYSTem:COMMunicate:LAN:IPAdDress?	Page 113
:SYSTem:COMMunicate:LAN:AUTOip[:STATe] 	Page 113
:SYSTem:COMMunicate:LAN:AUTOip[:STATe]?	Page 114
:SYSTem:COMMunicate:LAN:SMASk <Mask>	Page 114
:SYSTem:COMMunicate:LAN:SMASk?	Page 114
:SYSTem:COMMunicate:LAN:GATEway <IP address>	Page 114
:SYSTem:COMMunicate:LAN:GATEway?	Page 115
:SYSTem:COMMunicate:LAN:DNS <Address>	Page 115
:SYSTem:COMMunicate:LAN:DNS?	Page 115
:SYSTem:COMMunicate:LAN:MANualip[:STATe] 	Page 116
:SYSTem:COMMunicate:LAN:MANualip[:STATe]?	Page 116
:SYSTem:COMMunicate:LAN:APPLY	Page 116
:SYSTem:VERSion?	Page 110
:SYSTem:ERRor?	Page 110

:SYSTem:CLEar	Page 111
:SYSTem:LFRequency?	Page 111
:SYSTem:POSetup <name>	Page 111
:SYSTem:POSetup?	Page 112
:SYSTem:BEEPer:STATe {0 1 OFF ON}	Page 116
:SYSTem:BEEPer:STATe?	Page 117

System Related Commands

*IDN?	Page 118
*RST	Page 118
*TST?	Page 118
*WAI	Page 119

IEEE488.2 Common Commands IEEE488.2

*CLS	Page 128
*ESE<Enable Value>	Page 127
*ESE?	Page 127
*ESR?	Page 127
*OPC	Page 128
*OPC?	Page 128
*SRE <Enable Values>	Page 126
*SRE?	Page 126
*STB?	Page 127
*TRG	Page 119
*SAV <NRf>	Page 119
*RCL <NRf>	Page 119

Command Details

Measurement Commands

Command	:FETCh?
Function	Returns the last readback value.
Response Time	Maximum: 16ms.

Example	:FETCh? Returns the last readback value.
---------	---

Command	:FETCh:ARRay?
Function	Returns the last array readback values.
Response Time	Maximum: 16ms

Example	:FETCh:ARRay? Returns the last array readback values
---------	---

Command	:READ?
Function	Triggers a read operation and returns the read values.
Response time	Maximum: 32ms

Example	:READ? Returns the read values.
---------	------------------------------------

Command	:READ:ARRay?
Function	Triggers a new array. Returns the read array values.
Response time	Max: 32ms

Example	:READ:ARRay? Triggers a new array. Returns the read array values.
---------	--

Command	:MEASure[:<function>]?
Function	Performs a “READ?” query on the specified measurement function.
Description	<p><function> CURRent[:DC]: Measures the current.</p> <p>VOLTage[:DC]: Measures the voltage.</p> <p>PCURrent: Measures the pulse current.</p> <p>DVMeter: Measures the DVM input.</p> <p>LINTegration: Long integration current measurement.</p> <p>For pulse current and long integration current measurement, if there is no pulse, test for the timeout time.</p>
Response time	Maximum: 32ms

Example :MEASure: CURRent?
Sets pulse current as the measurement type and reads back the pulse current value.

Command	:MEASure:ARRay[:<function>]?
Function	Performs a “READ:ARRay?” query on the specified measurement function.
Description	<p><function> CURRent[:DC]: Measures the current.</p> <p>VOLTage[:DC]: Measures the voltage.</p> <p>PCURrent: Measures the pulse current.</p> <p>DVMeter: Measures the DMV input.</p> <p>LINTegration: Long integration current measurement</p>

For pulse current and long integration current measurement, if there is no pulse, test for the timeout time.

Response time Maximum: 32ms

Example :MEASure:ARRay:PCURrent?

Sets the measurement type to pulse current array measurement and returns the read array value.

Display Commands

Command :DISPlay:ENABLE

Function Turn the LCD display on or off.

Description b 0/OFF: Turns the display off.
 1/ON: Turns the display on.

Example :DISPlay:ENABLE ON
 Turns the LCD display on.

Command :DISPlay:ENABLE?

Function Queries the state of the display.

Example :DISPlay:ENABLE?
 Returns the state of the display.

Command :DISPlay[:WINDow[1]]:TEXT:STATe

Function Enable or disable text message mode.

Description 0/OFF: Disable text message mode.
 1/ON: Enable text message mode.

Example :DISPlay: TEXT:STATe ON
 Enables text message mode.

Command	:DISPlay[:WINDow[1]]:TEXT:STATe?
Function	Returns the state of the text message mode.
Example	:DISPlay:TEXT:STATe? Returns the state of the text message mode.
Command	:DISPlay[:WINDow[1]]:TEXT:DATA <a>
Function	Defines the ASCII text for display information "a".
Description	<a> ASCII string of block of up to 32 characters. Any character over 32 will be truncated. The characters are not case-sensitive. Used when ":DISPlay:TEXT:STATe ON" is executed.
Example	:DISPlay:TEXT:DATA" txt" The ASCII text is set to "txt".
Command	:DISPlay[:WINDow[1]]:TEXT:DATA?
Function	Returns the text message that was set.
Example	:DISPlay:TEXT:DATA? Returns the text message that was set.
Command	DISPlay:CONTRast < NRf >
Function	Sets backlight display brightness.
Description	<NRf> 1: Weak 2: Medium 3: Strong

Example DISPlay:CONTRast 3
 Sets the backlight to the brightest.

Measurement Commands

Command :FORMat[:DATA] <type>
 Function Sets the data format.
 Description <type> ASCIi: ASCII format.
 SREal: IEEE754 single precision format.
 DREal: IEEE754 double precision
 format.

Example :FORMat:DATA SREal
 Sets the format to IEEE754 double precision format.

Command :FORMat[:DATA]?
 Function Queries the data format.

Example :FORMat:DATA?
 Returns the data format.

Command :FORMat:BORDER <name>
 Function Sets the byte order.
 Description name NORMal: normal binary byte order.
 SWAPped: reverse binary byte order.

Example :FORMat:BORDER NORMal
 Set the data format to the “Normal” binary byte
 order.

Command :FORMat:BORDER?

Function Queries the binary byte order.

Example :FORMat:BORDER?
 Returns the binary byte order.

Output Commands

Command :OUTPut[:STATe]

Function Turns the output on or off.

Description 0/OFF: Turn off the output
 1/ON: Turn on the output

Example :OUTPut:STATe ON
 Turns on the output.

Command :OUTPut[:STATe]?

Function Queries the output state.

Example :OUTPut:STATe?
 Returns the output state.

Command :OUTPut:RELAy <name>

Function Turns the external relay control signal on or off.

Description <name> ZERO: Off
 ONE: On

Example :OUTPut:RELAy ONE
 Turn the relay signal on.

Command :OUTPut:RELAy?

Function Queries the state of the output relay.

Example :OUTPut:RELAy?
Returns the state of the output relay.

Command :OUTPut:OVP:STATe
Function Turns OVP protection on/off
Description 0/OFF: Turns OVP off.
 1/ON: Turns OVP on.

Example :OUTPut:OVP:STATe ON
Turn on OVP.

Command :OUTPut:OVP:STATe?
Function Queries the status of the OVP function.

Example :OUTPut:OVP:STATe?
Returns the status of the OVP function.

Command :OUTPut:OVP <value>
Function Sets the OVP level.
Description <value> 0.00-15.00

Example :OUTPut:OVP 10.05
Sets the OVP voltage to 10.05V.

Command :OUTPut:OVP?
Function Queries the OVP voltage level.

Example :OUTPut:OVP?
Returns the OVP voltage level.

Source Commands

Command :[SOURce]:CURRent[:LIMit][:VALue] <NRf>

Description Sets the current level.

NRf 0.0000-5.0000

Example :SOURce:CURRent 1.0005

Sets the current level to 1.0005A.

Command :[SOURce]:CURRent[:LIMit][:VALue]?

Description Queries the current limit level.

Example :SOURce:CURRent?

Returns the current limit level.

Command :[SOURce]:CURRent[:LIMit]:TYPE <name>

Function Sets the current limit mode.

Description <name> LIMit: General limiting mode
 TRIP: Output shutdown mode
 LIMRELAY | LIMITRELAY: General limiting mode and external relay output control mode.
 TRIPRELAY: Output shutdown mode and external relay output control mode.

Example :SOURce:CURRent:TYPE LIMITRELAY

Sets the current limit mode to LIMITRELAY.

Command	: [SOURce]:CURRent[:LIMit]:TYPE?
Function	Queries the current limiting mode.
Example	: SOURce:CURRent:TYPE? Returns the current limiting mode.
Command	: [SOURce]:CURRent[:LIMit]:STATe?
Function	Queries the current limit state. Returns 0 if the current limit has not been reached, returns 1 if the current limit has been reached.
Example	: SOURce:CURRent:STATe? Returns the current limit state.
Command	: [SOURce]:VOLTage[:LEVel][:IMMediate][:AMP Litude] < NRf >
Function	Sets the output voltage amplitude.
Description	<NRf> 0.000-15.000
Example	: SOURce:VOLTage 5.321 Sets the output voltage to 5.321V.
Command	: [SOURce]:VOLTage[:LEVel][:IMMediate] [:AMPLitude]?
Function	Queries the output voltage setting.
Example	: SOURce:VOLTage? Returns the output voltage setting.

Readback Commands

Command	:SENSe[1]:FUNctIon <name>
Function	Selects the type of measurement function: voltage, current, pulse, long integration and DVM measurement.
Description	name "VOLTage": Voltage measurement. "CURRent": Current measurement. "PCURrent": Pulse current measurement. "LINTegration": Long integration measurement. "DVMeter": DVM input measurement.

Example :SENSe:FUNctIon "VOLTage"
 Selects "Voltage" as the measurement type.

Command	:SENSe[1]:FUNctIon?
Function	Queries the type of measurement function.
Response time	Maximum: 16ms

Example :SENSe:FUNctIon?
 Returns the type of measurement function.

Command	:SENSe[1]:NPLCycles <n>
Function	Sets the number of PLCs for the integration rate for voltage, current and DVM measurements.
Description	<n> 0.01-10.00

Example :SENSe:NPLCycles 0.10
 Sets the number of PLCs to 0.1.

Command	:SENSe[1]:NPLCycles?
Function	Returns the number of power line cycles used for the integration rate.
Example	:SENSe:NPLCycles? Returns the number of PLCs.
Command	:SENSe[1]:AVERage <NRf>
Function	Sets the averaging number for the voltage, current and DVM measurements.
Description	<NRf> 1-10
Example	:SENSe:AVERage 3 Sets the averaging number to 3.
Command	:SENSe[1]:AVERage?
Function	Returns the average number.
Example	:SENSe:AVERage? Returns the average number.
Command	:SENSe[1]:CURRent[:DC]:RANGe[:UPPer] <n>
Description	Sets the current measurement range.
Description	<n> MIN: low range MAX: high range
Example	:SENSe:CURRent:RANGe MIN Sets the current range to low.
Command	:SENSe[1]:CURRent[:DC]:RANGe[:UPPer]?

Function	Queries the current measurement range
Example	:SENSe:CURRent:RANGe? Returns the current measurement range.
Command	:SENSe[1]:CURRent[:DC]:RANGe:AUTO
Function	Turns the automatic range function.
Description	 0/OFF: Turn off. 1/ON: Turn on.
Example	:SENSe:CURRent:RANGe:AUTO ON Turns the automatic range function on.
Command	:SENSe[1]:CURRent[:DC]:RANGe:AUTO?
Function	Queries the state of the automatic range function.
Example	:SENSe:CURRent:RANGe:AUTO? Returns the status of the automatic range function.
Command	:SENSe[1]:PCURrent:AVERAge <NRf>
Function	Sets the averaging number for pulse current measurements.
Description	NRf 1-100 or 1-5000(pulse current digitization)
Example	:SENSe:PCURrent:AVERAge 5 Sets the average number to 5.

Command	:SENSe[1]:PCURrent:AVERage?
Function	Returns the average number for pulse current measurement.
Example	:SENSe:PCURrent:AVERage? Returns the average number.
Command	:SENSe[1]:PCURrent:MODE <name>
Function	Sets the pulse current measurement mode.
Description	Name HIGH: High pulse mode (trigger on the rising edge). LOW: Low pulse mode (trigger on the falling edge) AVERage: Average pulse measurement.
Example	:SENSe:PCURrent:MODE HIGH Sets the pulse current measurement mode to HIGH mode.
Command	:SENSe[1]:PCURrent:MODE?
Function	Queries the pulse current measurement mode.
Example	:SENSe:PCURrent:MODE? Returns the pulse current measurement mode.
Command	:SENSe[1]:PCURrent:TIME:AUTO
Function	Sets the pulse current integegration time to automatic.
Example	:SENSe:PCURrent:TIME:AUTO Sets the pulse current integegration time to automatic.

Command	:SENSe[1]:PCURrent:TIME:HIGH <NRf>
Function	Sets the integration time for high pulse measurement.
Description	<NRf> 33.3~ 833333, Step resolution of 33.3.

Example	:SENSe:PCURrent:TIME:HIGH 0.000233 Sets the integration time for high pulse measurement to 233uS.
---------	--

Command	:SENSe[1]:PCURrent:TIME:HIGH?
Function	Queries integration time for high pulse measurement.

Example	:SENSe:PCURrent:TIME:HIGH? Returns the integration time for high pulses.
---------	---

Command	:SENSe[1]:PCURrent:TIME:LOW <NRf>
Function	Sets the integration time for low pulse measurement.
Description	<NRf> 33.3-833333, Step resolution of 33.3

Example	:SENSe:PCURrent:TIME:LOW 0.000233 Sets the integration time for low pulse measurement to 233uS.
---------	--

Command	:SENSe[1]:PCURrent:TIME:LOW?
Function	Returns the integration time for low pulse measurement.

Example	:SENSe:PCURrent:TIME:LOW? Returns the integration time for low pulse measurement.
Command	:SENSe[1]:PCURrent:TIME:AVERAge <NRf>
Function	Sets the integration time for the average pulse measurement.
Description	NRf 33-833333, step resolution of 33.3

Example	:SENSe:PCURrent:TIME:AVERAge 0.000233 Sets the integration time for average pulse measurement to 233 microseconds.
Command	:SENSe[1]:PCURrent:TIME:AVERAge?
Function	Returns the integration time for the average measurement.

Example	:SENSe:PCURrent:TIME:AVERAge? Returns the integration time for the average measurement.
Command	:SENSe[1]:PCURrent:SYNChronize[:STATe]
Function	Sets the triggering option for pulse current measurement.
Description	 0 /OFF: Digital trigger mode. 1 /ON: Pulse level trigger mode.

Example	:SENSe:PCURrent:SYNChronize ON The trigger mode is set to the pulse level trigger.
---------	---

Command :SENSe[1]:PCURrent:SYNChronize[:STATe]?
Function Queries the pulse current measurement triggering option.

Example :SENSe:PCURrent:SYNChronize?
Returns the pulse current trigger option.

Command :SENSe[1]:PCURrent:SYNChronize:DELay <NRf>
Function Sets the trigger delay time.
Description <NRf> 0~0.1 or 0~5 (Pulse current digitization)

Example :SENSe:PCURrent:SYNChronize:DELay 0.05
Sets the trigger delay time to 0.05 seconds.

Command :SENSe[1]:PCURrent:SYNChronize:DELay?
Function Queries the trigger delay time.

Example :SENSe:PCURrent:SYNChronize:DELay?
Returns the trigger delay time.

Command :SENSe[1]:PCURrent:SYNChronize:TLEVel<NRf>
Function Sets the trigger level.
Description <NRf> 0.000-5.000
Example :SENSe:PCURrent:SYNChronize:TLEVel 1
Sets the trigger level to 1.000A.

Command	:SENSe[1]:PCURrent:SYNChronize:TLEVel?
Function	Queries the trigger level.
Example	:SENSe:PCURrent:SYNChronize:TLEVel? Returns the trigger level.
Command	:SENSe[1]:LINTegration:TIME <NRf>
Function	Sets the long integration integration time.
Description	<NRf> X (power line frequency: X=0.840 for 50Hz, X=0.850 for 60Hz)
Example	:SENSe:LINTegration:TIME 1.2 Sets the long integration time to 1.2S.
Command	:SENSe[1]:LINTegration:TIME?
Function	Queries the the long integration time.
Example	:SENSe:LINTegration:TIME? Returns the long integration time.
Command	:SENSe[1]:LINTegration:TIME:AUTO
Function	Sets the long itegration time to the auto setting.
Example	:SENSe:LINTegration:TIME:AUTO Sets the long itegration time to the auto setting.
Command	:SENSe[1]:LINTegration:TLEVel <NRf>
Function	Sets the long integration trigger level.
Description	<NRf> 0.000-5.000

Example	:SENSe:LINTEgration:TLEVel 1.2 Sets the long integration trigger level to 1.2A.
Command	:SENSe[1]:LINTEgration:TLEVel?
Function	Queries the long integration trigger level setting.

Example	:SENSe:LINTEgration:TLEVel? Returns the long integration trigger level.
Command	:SENSe[1]:LINTEgration:TEDGE <name>
Function	Sets the long integration triggering edge.
Description	<name> RISING: Rising triggering edge. FALLING: Falling triggering edge. NEITHER: No triggering edge.

Example	:SENSe:LINTEgration:TEDGE RISING Sets the long integration triggering edge to rising edge.
Command	:SENSe[1]:LINTEgration:TEDGE?
Function	Queries the long integration triggering edge.

Example	:SENSe:LINTEgration:TEDGE? Returns the long integration triggering edge.
Command	:SENSe[1]:LINTEgration:TimeOUT <NRf>
Function	Sets the timeout time for the long integration measurement.
Description	<NRf> 1-63

Example	:SENSe:LINTEgration:TimeOUT 2 Sets the timeout time to 2 seconds.
Command	:SENSe[1]:LINTEgration:TimeOUT?
Fucntion	Queries the timeout time.

Example	:SENSe:LINTEgration:TimeOUT? Returns the timeout time.
Command	:SENSe[1]:LINTEgration:SEARCh
Function	Turns the long integration pulse measurement search function on or off.
Description	 0/OFF: Disable 1/ON: Enable

Example	:SENSe:LINTEgration:SEARCh ON Turns the search function on.
Command	:SENSe[1]:LINTEgration:SEARCh?
Function	Queries the long integration search function state.

Example	:SENSe:LINTEgration:SEARCh? Returns the long integration search function state.
Command	:SENSe[1]:LINTEgration:FAST
Function	Enable or disable the long intergration fast measurement mode.
Description	 0/OFF: Disable 1/ON: Enable

Example :SENSe:LINTEgration:FAST ON
Enables the long integration fast measurement mode.

Command :SENSe[1]:LINTEgration:FAST?
Function Query the state of the long integration fast measurement mode.

Example :SENSe:LINTEgration:FAST?
Returns the state of the long integration fast measurement mode.

Status Commands

Command :STATus:PRESet
Function Resets the unit to the default settings.

Example :STATus:PRESet

Command :STATus:OPERation[:EVENTt]?
Function Read the operation event register.

Example :STATus:OPERation?
Reads the operation event register.

Command :STATus:OPERation:CONDition?
Function Read the operation condition status register.

Example :STATus:OPERation:CONDition?
Returns the contents of the operation condition status register.

Command	:STATus:OPERation:ENABLE <NRf>
Function	Programs the operation enable status register.
Description	<NRf> 8: CL (Current enable bit). 16: CLT (Current limit tripped enable bit). 64: PSS (Power supply shutdown enable bit).

Example	:STATus:OPERation:ENABLE 64 Enable the the power supply shutdown bit.
---------	--

Command	:STATus:OPERation:ENABLE?
Function	Read the operation enable status register.

Example	:STATus:OPERation:ENABLE? Returns the contents of the operation enable status register.
---------	--

Command	:STATus:MEASurement[:EVENT]?
Function	Reads the measurement event status register.

Example	:STATus:MEASurement? Returns the contents of the measurement event status register.
---------	--

Command	:STATus:MEASurement:ENABLE <NRf>
Function	Program the measurement enable status register.

Description	<NRf>	8: ROF (reading overflow enable bit). 16: PTT (pulse trigger timeout enable bit). 32: RAV (Reading available enable bit). 512: Buffer full enable bit.
Example	:STATus:MEASurement:ENABle 8	Enables the ROF bit.
Command	:STATus:MEASurement:ENABle?	
Function		Read the measurement enable status register.
Example	:STATus:MEASurement:ENABle?	Returns the contents of the measurement enable status register.
Command	:STATus:MEASurement:CONDition?	
Function		Read the measurement condition status register.
Example	:STATus:MEASurement:CONDition?	Returns the contents of the measurement condition status register.
Command	:STATus:QUEStionable[:EVENT]?	
Function		Read the questionable event status register.
Example	:STATus:QUEStionable?	Returns the contents of the questionable event status register.
Command	:STATus:QUEStionable:CONDition?	
Function		Read the questionable condition status register.

Example :STATus:QUESTionable:CONDition?
Returns the contents of the questionable condition status register.

Command :STATus:QUESTionable:ENABle <NRf>

Function Programs the questionable enable status register.

Description <NRf> 256: CAL (Calibration summary enable bit).

Example :STATus:QUESTionable:ENABle 256
Sets the CAL bit.

Command :STATus:QUESTionable:ENABle?

Function Read the questionable enable status register.

Example :STATus:QUESTionable:ENABle?
Returns the contents of the questionable enable status register.

Command :STATus:QUEue[:NEXT]?

Function Read the next message in the error queue.

Example :STATus:QUEue?
Returns the next error message.

Command :STATus:QUEue:ENABle <list>

Function Specifies which error and status messages get enabled for the error queue.

Example :STATus:QUEue:DISable (-110:-222)
The error messages in the range of -110 to -222 will not appear in the error queue.

Command :STATus:QUEue:DISable?

Function Reads the disabled messages.

Example :STATus:QUEue:DISable?
Returns the disabled messages.

Command :STATus:QUEue:CLEar

Function Empty all the messages from the error queue.

Example :STATus:QUEue:CLEar
Empty all the messages from the error queue.

System Commands

Command :SYSTem:VERSion?

Function Query the SCPI version.

Example :SYSTem:VERSion?
Returns the SCPI version.

Command :SYSTem:ERRor?

Function Read and clear the last error and from the error queue.

Example :SYSTem:ERRor?
Read and clear the last error and from the error queue.

Command	:SYSTem:CLEar
Function	Clear the error messages from the error queue.
Example	:SYSTem:CLEar Clears the error queue.
Command	:SYSTem:LFRequency?
Function	Queries the power line frequency.
Example	:SYSTem:LFRequency? Returns the power line frequency.
Command	:SYSTem:POSetup <name>
Function	Set the power on configuration.
Description	<name> RST: Machine default settings. SAV0: User settings stored in memory location 0 (output off). SAV1: User settings stored in memory location 1 (output off). SAV2: User settings stored in memory location 2 (output off). SAV3: User settings stored in memory location 3 (output off). SAV4: User settings stored in memory location 4 (output off). SAV5: User settings stored in memory location 5. SAV6: User settings stored in memory location 6. SAV7: User settings stored in memory location 7.

SAV8: User settings stored in memory location 8.

SAV9: User settings stored in memory location 9.

Example :SYSTem:POSetup SAV0
Set the power on configuration to SAV0.

Command :SYSTem:POSetup?
Function Query the power on configuration.

Example :SYSTem:POSetup?
Returns the power on configuration.

Command :SYSTem:COMMunicate:LAN:DHCP[:STATe]

Function Sets the DHCP state on or off.

Description 0/OFF: DHCP off
1/ON: DHCP on

Note: The :SYSTem:COMMunicate:LAN:APPLY command must be executed before the DHCP settings can take effect.

Example :SYSTem:COMMunicate:LAN:DHCP ON
Enable DHCP.

Command :SYSTem:COMMunicate:LAN:DHCP[:STATe]?
Function Query the DHCP status.

Example :SYSTem:COMMunicate:LAN:DHCP?
Returns the DHCP state.

Command :SYSTem:COMMunicate:LAN:IPADdress
<IPaddress>

Function Sets the IP address.

Description <IP ASCII string, within the range of 1.0.0.0
address> to 223.255.255.255 (excluding
127.nnn.nnn.nnn).

Note: This commands is only applicable if for the manual IP mode. The SYSTem:COMMunicate:LAN:APPLY command needs to executed before the IP address settings can take effect.

Example :SYSTem:COMMunicate:LAN:IPADdress
172.131.161.152

Sets the IP address to 172.131.161.152.

Command :SYSTem:COMMunicate:LAN:IPADdress?

Function Queries the IP address.

Example :SYSTem:COMMunicate:LAN:IPADdress?

Returns the IP address.

Command :SYSTem:COMMunicate:LAN:AUTOip[:STATe]

Function Turn the AUTO IP function on or off.

Description 0/OFF: AUTO IP off.
1/ON: AUTO IP on.

The SYSTem:COMMunicate:LAN:APPLY command needs to be executed before the AUTO IP function setting can take effect.

Example :SYSTem:COMMunicate:LAN:AUTOip ON

Turns the AUTO IP function on.

Command	:SYSTem:COMMunicate:LAN:AUTOip[:STATe]?
Function	Queries the status of the AUTO IP function.
Example	:SYSTem:COMMunicate:LAN:AUTOip? Returns the status of the AUTO IP function.
Command	:SYSTem:COMMunicate:LAN:SMASk <mask>
Function	Sets the subnet mask.
Description	<mask> ASCII string, within the range of 1.0.0.0 to 255.255.255.255. The SYSTem:COMMunicate:LAN:APPLY command needs to be executed before the subnet mask setting can take effect.
Example	:SYSTem:COMM:LAN:SMAS 255.255.255.0 Sets the subnet mask to 255.255.255.0.
Command	:SYSTem:COMMunicate:LAN:SMASk?
Function	Query the subnet mask.
Example	:SYSTem:COMMunicate:LAN:SMASk? Returns the subnet mask.
Command	:SYSTem:COMMunicate:LAN:GATEway <IPaddress>
Function	Sets the gateway IP address.
Description	<IP address> ASCII string, within the range of 1.0.0.0 to 223.255.255.255 (excluding 127.nnn.nnn.nnn).

The SYSTem:COMMunicate:LAN:APPLY command needs to be executed before the gateway IP address setting can take effect.

Example :SYSTem:COMMunicate:LAN:GATEway
172.16.3.1

Sets the gateway IP to 172.16.3.1.

Command :SYSTem:COMMunicate:LAN:GATEway?

Function Queries the gateway IP.

Example :SYSTem:COMMunicate:LAN:GATEway?

Returns the gateway IP.

Command :SYSTem:COMMunicate:LAN:DNS <IPaddress>

Function Sets the DNS IP address.

Description <IP address> ASCII string, within the range of 1.0.0.0 to 223.255.255.255 (excluding 127.nnn.nnn.nnn).

The SYSTem:COMMunicate:LAN:APPLY command needs to be executed before the DNS IP address setting can take effect.

Example :SYSTem:COMMunicate:LAN:DNS 172.16.2.3

Sets the DNS address to 172.16.2.3.

Command :SYSTem:COMMunicate:LAN:DNS?

Function Queries the DNS addresss.

Example :SYSTem:COMMunicate:LAN:DNS?

Returns the DNS address.

Command :SYSTem:COMMunicate:LAN:MANualip[:STATe]

Function Allow the IP address to be set manually.
 0/OFF: disable the manual IP address.
1/ON: enable the manual IP address.

Example :SYSTem:COMMunicate:LAN:MANualip ON
Enables a manual IP address to be set.

Command :SYSTem:COMMunicate:LAN:MANualip[:STATe]
?

Function Queries whether manual IP addressing has been
enabled or disabled.

Example :SYSTem:COMMunicate:LAN:MANualip?
Returns the status of the manual IP addressing.

Command :SYSTem:COMMunicate:LAN:APPLY

Function When this command is executed, all the LAN
settings are applied.

Example :SYSTem:COMMunicate:LAN:APPLY
Applies all the LAN settings.

Command :SYSTem:REMote

Function Sets the unit to remote control.

Example :SYSTem:REMote
Sets to remote control mode

Command :SYSTem:BEEPer:STATe

Function Turn the buzzer on or off.

 0/OFF: Turn the buzzer off.
1/ON: Turn the buzzer on.

Example :SYSTem:BEEPer:STATe OFF
Turns the buzzer off.

Command :SYSTem:BEEPer:STATe?
Function Queries the buzzer status.

Example :SYSTem:BEEPer:STATe?
Returns the buzzer status.

Command :SYSTem:LOCAl
Function Disable remote control mode and return to local control.

Example :SYSTem:LOCAl
Disables remote control mode.

System Related Commands

Command	*IDN?
Function	Read the instrument identification <string>.
Description	<string> The return string contains four field, each separated by a comma. The first field is the manufacturer, followed by the model name, serial number and the version number.

Example *IDN?
Returns: GW,PPH-1503,XXXXXXXX,V0.62
GW: Manufacturer,
PPH-1503: Model name,
XXXXXXXX: Serial number,
V0.62: version number.

Command	*RST
Function	Resets the unit to RST default conditions.

Example *RST
Resets the unit.

Command	*TST?
Function	Performs checksum test on the RAM. Return value 0: No errors 2: Indicates that there is a RAM error.

Example *TST?
Return 0 if there are no errors, returns 2 if there is an error.

Command	*WAI
Function	Waits for all pending operations to be completed before allowing other operations to be executed.

Example	*WAI
---------	------

Command	*TRG
Function	Sends a bus trigger.

Example	*TRG Sends a bus trigger.
---------	------------------------------

Command	*SAV <NRf>
Function	Save the current setup to the selected save location.
Description	<NRf> 0: Save to memory location SAV0 1: Save to memory location SAV1 2: Save to memory location SAV2 3: Save to memory location SAV3 4: Save to memory location SAV4

Example	*SAV 3 Save the current setup to SAV3.
---------	---

Command	*RCL <NRf>
Function	Recall the selected save setting from memory.

Description	<NRf>	0: Recall SAV0 from memory. 1: Recall SAV1 from memory. 2: Recall SAV2 from memory. 3: Recall SAV3 from memory. 4: Recall SAV4 from memory.
-------------	-------	---

Example	*RCL 2 Recall SAV2.
---------	------------------------

SCPI Status Registers SCPI

The SCPI instrument configuration is controlled by the status registers. The Status system records various instrument conditions into three main register groups: The status byte register, the standard event register group and the questionable data register group. The status byte register records a high-level summary of the other register groups. The following diagram is the SCPI Status System diagram.

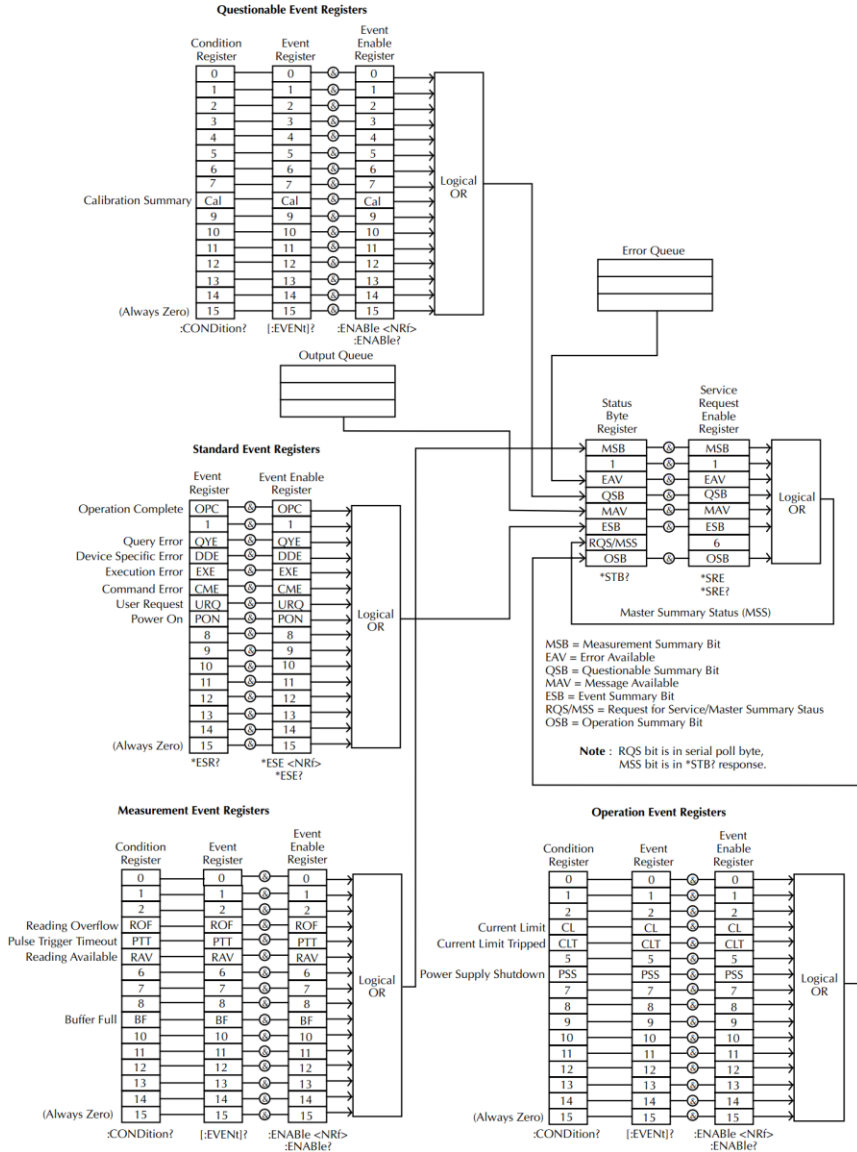

Event Registers

The operation, measurement and questionable status register groups all have event registers. The event registers are read only registers that reflect the status of the unit. Individual bits in the event registers are latched (set) when a corresponding event occurs and will remain latched even if the corresponding event changes, as long as the event bit is still set. The register query (*ESR) or the command (*CLS) will automatically clear any set bits in the event registers. The reset command (*RST) will not clear the bits in the event register. Queries for the event registers will return a binary-weighted decimal value that represents the state of all the bits in an event register.

Enable Registers

The enable registers define which bits in the corresponding event register can be latched (set). The enable register can be read and written to. Any queries for the enable register will not clear the value in the register. The *CLS command will not clear the enable register, but will clear the events in the event register. To allow the individual bits in the event registers to be set, the corresponding bits in the enable registers must be set, where each bit is represented by a binary number.

Status Byte Register

The status byte register reports the status of the other status registers. The message available bit (bit 4), will indicate when there is a message in the output buffer. Clearing an event register will clear the corresponding bit in the status byte condition register. Reading all the data in the output buffer will clear the message available bit. To set the enable register mask for the status byte register and to generate an SRQ (service request) you must use the *SRE command to write the appropriate decimal value to the register.

Bit Definition for the Status Byte Register

Bit number	Decimal value	Definition

0 Not used	1	Not used, returns "0"
1 Not used	2	Not used, returns "0"
2 Error Queue	4	Indicates that one or more errors are stored in the error queue.
3 Questionable Summary bit	8	One or more bits are set in the questionable data register (for enabled events).
4 Message Available bit	16	Indicates that a message is available in the output queue.
5 Standard Event Summary bit.	32	Indicates that one or more bits are set in the standard event register. (for enabled events).
6 Master Summary bit	64	Indicates that a summary bit is set in the status byte register. (for enabled summary bits)
7 Unused	128	Not used, returns "0"

The status byte condition register is cleared when one of the following occurs:

- *CLS command is used to clear the status byte register.
- The event registers are read

The status byte enable register is cleared when the following occurs:

- When the *SRE 0 is command is executed.

Use the *STB? query to read the status byte register.

The *STB? query will return the contents of the status byte register as long as the bit 6 (MSS) has been cleared.

Using the *OPC? query to place a signal in the output buffer.

In general it is best to use the Operation Complete Bit (bit 0) in the standard event register to check to see if an operation/command has completed. After executing the *OPC command, the OPC bit will be set to 1. If a command or query is placed in the output buffer immediately before the *OPC command is sent, the Operation Complete Bit can be used to determine when the information can be used. However if too many commands/queries are

executed prior to the execution of the *OPC command, the output buffer could become saturated and the unit will stop taking readings.

Standard Event Register

The Standard Event Register reports the following types or events: Power on has been detected, command syntax errors, command execution errors, self test and execution errors, query errors or if the *OPC command is executed. Any one or more of these events will set the standard event summary bit in the status byte register. To set a mask for the enable register, a binary-weighted decimal number must be written using the *ESE command.

Bit Definition for the Standard Event Register

Bit number	Decimal value	Definition
0 Operation Complete Bit	1	The *OPC command will set this bit when all overlapping operations have completed (including the *OPC command itself).
1 Not used	2	Not used, returns 0.
2 Query Error	4	The instrument tried to read the error queue when the queue was empty or the queue was read before a new command was given or the input/output buffers are full.
3 Device Error	8	A self-test, calibration or other device-specific error.
4 Execution Error	16	An execution error.
5 Command Error	32	A command syntax error.
6 Not used	64	Not used, return 0.
7 Power On	128	This bit is set if the power supply has been reset from the last time

		you read the event register.
--	--	------------------------------

The following will clear the standard event register:

- The *CLS command is executed.
- The *ERR? query is used read the event register.

The following will clear the standard event enable register.

- *ESE 0 is written to the standard event enable register.

Status Byte Register Commands

Command *SRE <Allowed values>

Function Service request enable register (SRER) command that writes a binary weighed value which determines which events in the status byte register are enabled.

Function Allowed Decimal vales: 0~255
values

Example *SRE 7
0000 0111
Returns the SRER setting (0000 0111)

Command *SRE?

Function Queries the status byte enable register. This command returns a binary-weighted decimal number that indicates which bits are set in the status byte register. The range is from 0~255.

Example *SRE?
0000 0111
Returns "7", which are the contents of the service request enable register.

Function	*STB?
Function	Query the status byte register. This is the same as performing a serial poll, however the master summary bit (MSS, bit 6) will not be cleared by the *STB command. The return value range is from 0 to 255.
Example	*STB? 81 Returns 81 if the status byte register is set to 0101 0001.

Standard Event Register Commands

Command	*ESE<Allowed Values>
Function	Sets the standard event enable register. The allowable value range is 0~255.
Example	*ESE 65 Sets the ESER as 0100 0001.
Command	*ESE?
Function	Queries the standard event enable register. It returns a binary-weighted decimal value representing all the enabled bits in the standard event register.
Example	*ESE? 65 Returns 65, as the ESER is set as 0100 0001.
Command	*ESR?

Function	Queries the standard event register. It returns a binary-weighted decimal value in the range of 0~255.
----------	--

Example	*ESR? 198
---------	--------------

It returns 198 as the standard event register has a binary value of 1100 0110.

Other Status Register Commands

Command	*CLS
---------	------

Function	Clears the status byte summary registers and the all event registers.
----------	---

Example	*CLS Clears all the event registers.
---------	---

Command	*OPC
---------	------

Function	After all the pending operations are complete, sets the operation complete bit in the standard event status register.
----------	---

Example	*OPC
---------	------

Command	*OPC?
---------	-------

Function	Will return "1" to the output queue when all pending operations have been completed.
----------	--

Example	*OPC? After the last command is executed, will return a "1" to the output queue.
---------	---

Errors

Error Message

- Errors are stored in a first in-first out (FIFO) order. The first error message that is returned is the first error message that was stored. When an error is read it is also cleared from the queue.
- If there are more than 10 errors produced the last error in the queue is replaced with “Que overflow”. Unless the error queue is cleared, no more errors can be written to the error queue. If there are no errors in the error queue, the instrument will return “No error”.
- To clear the error queue, you can use the :SYSTem:CLEar command or cycle the power. When you read a message from the error queue that message will be cleared from the error queue. Using the *RST command to reset the instrument does not clear the error queue.
- Remote control instructions can be used to clear the error queue. See the instructions listed in the previous chapter for details.

Command Errors

- 440 Query unterminated after indefinite
- 430 Response
- 420 Query deadlocked
- 410 Query unterminated
- 363 Query interrupted
- 350 Input buffer overrun
- 330 Queue overflow
- 314 Self-test failed
- 315 Save/recall memory lost
- 260 Configuration memory lost
- 241 Expression error

- 230 Hardware missing
- 225 Data corrupt or stale
- 224 Out of memory
- 223 Illegal parameter value
- 222 Too much data
- 221 Parameter data out of range
- 220 Settings conflict
- 200 Parameter error
- 178 Execution error
- 171 Expression data not allowed
- 170 Invalid expression
- 161 Expression error
- 160 Invalid block data
- 158 Block data error
- 154 String data not allowed
- 151 String too long
- 150 Invalid string data String data error
- 148 Character data not allowed
- 144 Character data too long
- 141 Invalid character data
- 140 Character data error
- 124 Too many digits
- 123 Exponent too large
- 121 Invalid character in number
- 120 Numeric data error
- 114 Header suffix out of range
- 113 Undefined header

- 112 Program mnemonic too long
- 111 Header separator error
- 110 Command header error
- 109 Missing parameter
- 108 Parameter not allowed
- 105 GET not allowed
- 104 Data type error
- 103 Invalid separator
- 102 Syntax error
- 101 Invalid character
- 100 Command error
- +000 No error
- +101 Operation complete
- +301 Reading overflow
- +302 Pulse trigger detection timeout
- +306 Reading available
- +310 Buffer full
- +320 Current limit event
- +321 Current limit tripped event
- +409 OTP Error
- +410 OVP Error
- +438 Date of calibration not set
- +440 Gain-aperture correction error
- +500 Calibration data invalid
- +510 Reading buffer data lost
- +511 GPIB address lost
- +512 Power-on state lost

- +514 DC Calibration data lost
- +515 Calibration dates lost
- +522 GPIB communication data lost
- +610 Questionable calibration
- +900 Internal system error

A PPENDIX

Replacing the Fuse

- Steps Remove the power cord and then take out the box using a small screw driver.

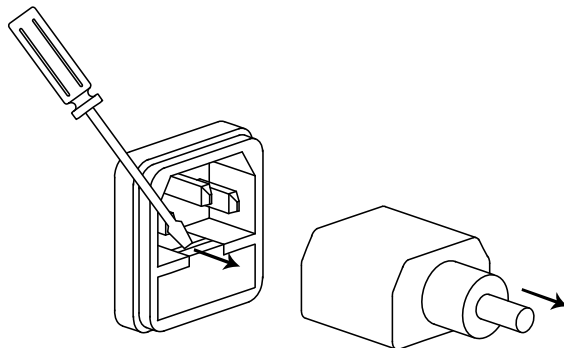

The fuse is stored in the housing.

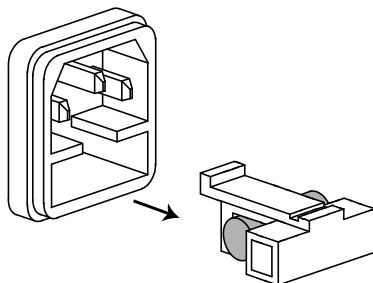

-
- Rating • T2.0A/250V

Specifications

The specifications apply under the following conditions: The PPH-1503 is powered on for at least 30 minutes, within +18°C~+28°C.

DC GENERAL	MEASUREMENT TIME CHOICES	0.01 ~ 10PLC ¹ , 0.01PLC/step
	AVERAGE READINGS	1~10
	TYPICAL READING TIME ^{2,3}	31ms
DC VOLTAGE OUTPUT (23°C±5°C)	OUTPUT VOLTAGE	0~15V
	OUTPUT ACCURACY	± (0.05%+10mV)
	PROGRAMMING RESOLUTION	2.5mV
	READBACK ACCURACY ³	± (0.05%+3mV)
	READBACK RESOLUTION	1mV
	OUTPUT VOLTAGE RISING TIME	0.15ms (10% ~ 90%)
	OUTPUT VOLTAGE FALLING TIME	0.65ms (90% ~ 10%)
	LOAD REGULATION	0.01%+2mV
	LINE REGULATION	0.5mV
	STABILITY ⁴	0.01%+0.5mV
	RECOVERY TIME(1000%LOAD CHANGE)	<40us (<100mV) <80us (<20mV)
	RIPPLE AND NOISE ⁵	1mV rms(0~1MHz) 8mVpp(20Hz~ 20MHz)
DC CURRENT (23°C±5°C)	OUTPUT CURRENT	0 ~ 5A (0 ~ 9V) 0 ~ 3A (9 ~ 15V)
	SOURCE COMPLIANCE ACCURACY	±(0.16%+5mA)
	PROGRAMMED SOURCE RESOLUTION	1.25mA
	READBACK ACCURACY ³	5A range: ±(0.2%+400uA) 5mA range: ±(0.2%+1uA)
	READBACK RESOLUTION	5A range: 100uA 5mA range: 0.1uA
	CURRENT SINK CAPACITY	0 ~ 5V: 2A 5 ~ 15V:(2A derate 0.1A)/V
	LOAD REGULATION	0.01%+1mA
	LINE REGULATION	0.5mA
	STABILITY ⁴	0.01%+50uA
	DVM	INPUT VOLTAGE RANGE
INPUT IMPEDANCE		10 ¹¹ Ω
MAXIMUM INPUT VOLTAGE		-3V, +22V
READING ACCURACY ³		± (0.05%+3mV)
READING RESOLUTION		1mV
PULSE CURRENT MEASUREMENT	TRIGGER LEVEL	5mA ~ 5A, 5mA/step
	HIGH TIME/LOW TIME/AVERAGE TIME	33.3us to 833ms, 33.3us/step
	TRIGGER DELAY	0 ~ 100ms, 10us/steps
	AVERAGE READINGS	1 ~ 100

	LONG INTEGRATION PULSE TIMEOUT	1S ~ 63S
	LONG INTEGRATION MEASUREMENT TIME	850ms(60Hz)/840ms(50Hz) ~ 60s, or AUTO time 16.7ms/steps(60Hz), 20ms/steps(50Hz)
	LONG INTEGRATION TRIGGER MODE	Rising, Falling, Neither
OVP	OVP RANGE	OFF, ON (0 ~ 15.2V)
	RESOLUTION	10mV
	ACCURACY	50mV
Others	PROGRAMMING	IEEE-488.2(SCPI)
	USER_DEFINABLE POWER_UP STATES	5 sets
	REAR PANEL CONNECTOR	8Pin:output*4, sense*2, DVM*2
	TEMPERATURE COEFFICIENT	0.1* specification/ °C
	POWER CONSUMPTION	150VA
	REMOTE/LOCATION CONNECTOR	USB/GPIB/LAN
	RELAY CONTROL CONNECTOR	150mA/15V 5Voutput, 100mA
Insulation	Chassis and Terminal	20MΩ or above (DC 500V)
	Chassis and AC cord	30MΩ or above (DC 500V)
Operation Environment	Indoor use, Altitude: ≤ 2000m Ambient temperature: 0 ~ 40°C Relative humidity: ≤ 80% Installation category: II, Pollution degree: 2	
STORAGE Environment	TEMPERATURE: -20°C ~ 70°C HUMIDITY: < 80%	
INPUT POWER	90-264VAC, 50/60Hz ⁶	
Accessories	CD 8cm User manual x1, Quick Start manual x1 Test lead GTL-117 x 1 GTL-203A x 1, GTL-204A x 1	
Dimensions	222 (W) x 86 (H) x 363 (D) mm	
Weight	Approx. 4.2kg	
Remarks	¹ PLC=PowerLineCycle, 1PLC = 16.7ms for 60Hz operation, 20ms for 50Hz operation; ² Display OFF, Speed includes measurement and binary data transfer out of GPIB; ³ PLC=1; ⁴ STABILITY:Following 15 minute warm-up, the change in output over 8 hours under ambient temperature, constant load, and line operating conditions; ⁵ The ground ring of the probe is pressed directly against the output ground of the power supply and the tip is in contact with the output voltage pin. ⁶ Auto detected at power-up;	

Optional Accessories

USB Cable

GTL-246

USB 2.0, A-B type

Declaration of Conformity

We

GOOD WILL INSTRUMENT CO., LTD.

(1) No.7-1, Jhongsing Rd., Tucheng City, Taipei County, Taiwan

(2) No. 69, Lu San Road, Suzhou City (Xin Qu), Jiangsu Sheng, China

declare, that the below mentioned product

Type of Product: Programmable High Precision DC Power Supply

Model Number: PPH-1503

are herewith confirmed to comply with the requirements set out in the Council Directive on the Approximation of the Law of Member States relating to Electromagnetic Compatibility (2004/108/EC) and Low Voltage Directive (2006/95/EC).

For the evaluation regarding the Electromagnetic Compatibility and Low Voltage Directive, the following standards were applied:

© **EMC**

EN 61326-1: 2006 Electrical equipment for measurement, control and laboratory use -- EMC requirements		
Conducted Emission		Electrostatic Discharge
Radiated Emission	Class A	EN 61000-4-2: 1995 + A1:1998 + A2:2001
EN 55011: 2007 + A2: 2007		Radiated Immunity
		EN 61000-4-3: 2006
Current Harmonics		Electrical Fast Transients
EN 61000-3-2: 2006		EN 61000-4-4: 2004
Voltage Fluctuations		Surge Immunity
EN 61000-3-3: 1995 + A2:2005		EN 61000-4-5: 2006
-----		Conducted Susceptibility
		EN 61000-4-6: 1996 + A1:2001
-----		Power Frequency Magnetic Field
		EN 61000-4-8: 1993 + A1:2001
-----		Voltage Dip/ Interruption
		EN 61000-4-11: 2004

© **Safety**

Low Voltage Equipment Directive 2006/95/EC
Safety Requirements
IEC/EN 61010-1: 2001