

# PWS2185, PWS2323, PWS2326, and PWS2721 Linear DC Power Supplies

## User Manual



**S J ELECTRONICS**  
POWER • TEST & MEASUREMENT



0800 583 4455



[sales@sjelectronics.co.uk](mailto:sales@sjelectronics.co.uk)

VISIT   
WEBSITE



071-2751-00

**Tektronix**



**PWS2185, PWS2323, PWS2326, and PWS2721  
Linear DC Power Supplies**

**User Manual**

Copyright © Tektronix. All rights reserved. Licensed software products are owned by Tektronix or its subsidiaries or suppliers, and are protected by national copyright laws and international treaty provisions.

Tektronix products are covered by U.S. and foreign patents, issued and pending. Information in this publication supersedes that in all previously published material. Specifications and price change privileges reserved.

TEKTRONIX and TEK are registered trademarks of Tektronix, Inc.

## **Contacting Tektronix**

Tektronix, Inc.  
14150 SW Karl Braun Drive  
P.O. Box 500  
Beaverton, OR 97077  
USA

For product information, sales, service, and technical support:

- In North America, call 1-800-833-9200.
- Worldwide, visit [www.tektronix.com](http://www.tektronix.com) to find contacts in your area.

## Warranty

Tektronix warrants that the product will be free from defects in materials and workmanship for a period of three (3) years from the date of original purchase from an authorized Tektronix distributor. If the product proves defective during this warranty period, Tektronix, at its option, either will repair the defective product without charge for parts and labor, or will provide a replacement in exchange for the defective product. Batteries are excluded from this warranty. Parts, modules and replacement products used by Tektronix for warranty work may be new or reconditioned to like new performance. All replaced parts, modules and products become the property of Tektronix.

In order to obtain service under this warranty, Customer must notify Tektronix of the defect before the expiration of the warranty period and make suitable arrangements for the performance of service. Customer shall be responsible for packaging and shipping the defective product to the service center designated by Tektronix, shipping charges prepaid, and with a copy of customer proof of purchase. Tektronix shall pay for the return of the product to Customer if the shipment is to a location within the country in which the Tektronix service center is located. Customer shall be responsible for paying all shipping charges, duties, taxes, and any other charges for products returned to any other locations.

This warranty shall not apply to any defect, failure or damage caused by improper use or improper or inadequate maintenance and care. Tektronix shall not be obligated to furnish service under this warranty a) to repair damage resulting from attempts by personnel other than Tektronix representatives to install, repair or service the product; b) to repair damage resulting from improper use or connection to incompatible equipment; c) to repair any damage or malfunction caused by the use of non-Tektronix supplies; or d) to service a product that has been modified or integrated with other products when the effect of such modification or integration increases the time or difficulty of servicing the product.

THIS WARRANTY IS GIVEN BY TEKTRONIX WITH RESPECT TO THE PRODUCT IN LIEU OF ANY OTHER WARRANTIES, EXPRESS OR IMPLIED. TEKTRONIX AND ITS VENDORS DISCLAIM ANY IMPLIED WARRANTIES OF MERCHANTABILITY OR FITNESS FOR A PARTICULAR PURPOSE. TEKTRONIX' RESPONSIBILITY TO REPAIR OR REPLACE DEFECTIVE PRODUCTS IS THE SOLE AND EXCLUSIVE REMEDY PROVIDED TO THE CUSTOMER FOR BREACH OF THIS WARRANTY. TEKTRONIX AND ITS VENDORS WILL NOT BE LIABLE FOR ANY INDIRECT, SPECIAL, INCIDENTAL, OR CONSEQUENTIAL DAMAGES IRRESPECTIVE OF WHETHER TEKTRONIX OR THE VENDOR HAS ADVANCE NOTICE OF THE POSSIBILITY OF SUCH DAMAGES.

[W16 – 15AUG04]



# Table of Contents

General Safety Summary .....	iii
Compliance Information .....	v
EMC Compliance .....	v
Safety Compliance .....	vii
Environmental Considerations .....	ix
Preface .....	x
Key Features .....	x
Getting Started .....	1
Standard Accessories .....	1
Options and Optional Accessories .....	1
Specifications .....	2
Operating Requirements .....	2
Installing the System .....	3
Cleaning .....	6
Operating Basics .....	7
Front Panel at a Glance .....	7
Rear Panel at a Glance .....	9
Front-panel Operation .....	10
Index .....	





# General Safety Summary

Review the following safety precautions to avoid injury and prevent damage to this product or any products connected to it.

To avoid potential hazards, use this product only as specified.

*Only qualified personnel should perform service procedures.*

## To Avoid Fire or Personal Injury

**Use proper power cord.** Use only the power cord specified for this product and certified for the country of use.

**Use proper voltage setting.** Before applying power, ensure that the line selector is in the proper position for the source being used.

**Ground the product.** This product is grounded through the grounding conductor of the power cord. To avoid electric shock, the grounding conductor must be connected to earth ground. Before making connections to the input or output terminals of the product, ensure that the product is properly grounded.

**Observe all terminal ratings.** To avoid fire or shock hazard, observe all ratings and markings on the product. Consult the product manual for further ratings information before making connections to the product.

**Power disconnect.** The power switch disconnects the product from the power source. See instructions for the location. Do not block the power switch; it must remain accessible to the user at all times.

**Do not operate without covers.** Do not operate this product with covers or panels removed.

**Do not operate with suspected failures.** If you suspect that there is damage to this product, have it inspected by qualified service personnel.

**Avoid exposed circuitry.** Do not touch exposed connections and components when power is present.

**Use proper fuse.** Use only the fuse type and rating specified for this product.

**Do not operate in wet/damp conditions.**

**Do not operate in an explosive atmosphere.**

**Keep product surfaces clean and dry.**

**Provide proper ventilation.** Refer to the manual's installation instructions for details on installing the product so it has proper ventilation.

## Terms in This Manual

These terms may appear in this manual:



---

**WARNING.** Warning statements identify conditions or practices that could result in injury or loss of life.

---



---

**CAUTION.** Caution statements identify conditions or practices that could result in damage to this product or other property.

---

## Symbols and Terms on the Product

These terms may appear on the product:

- DANGER indicates an injury hazard immediately accessible as you read the marking.
- WARNING indicates an injury hazard not immediately accessible as you read the marking.
- CAUTION indicates a hazard to property including the product.

The following symbol(s) may appear on the product:

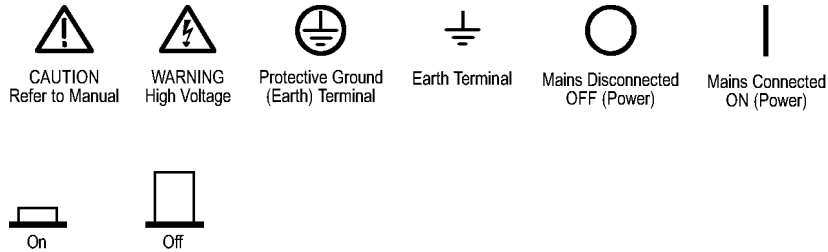

# Compliance Information

This section lists the EMC (electromagnetic compliance), safety, and environmental standards with which the instrument complies.

## EMC Compliance

### EC Declaration of Conformity – EMC

Meets intent of Directive 2004/108/EC for Electromagnetic Compatibility. Compliance was demonstrated to the following specifications as listed in the Official Journal of the European Communities:

**EN 61326-1 2006.** EMC requirements for electrical equipment for measurement, control, and laboratory use. <sup>1 2 3</sup>

- CISPR 11:2003. Radiated and conducted emissions, Group 1, Class A
- IEC 61000-4-2:2001. Electrostatic discharge immunity
- IEC 61000-4-3:2002. RF electromagnetic field immunity
- IEC 61000-4-4:2004. Electrical fast transient / burst immunity
- IEC 61000-4-5:2001. Power line surge immunity
- IEC 61000-4-6:2003. Conducted RF immunity
- IEC 61000-4-11:2004. Voltage dips and interruptions immunity <sup>4</sup>

**EN 61000-3-2:2006.** AC power line harmonic emissions

**EN 61000-3-3:1995.** Voltage changes, fluctuations, and flicker

### European contact.

Tektronix UK, Ltd.  
Western Peninsula  
Western Road  
Bracknell, RG12 1RF  
United Kingdom

- <sup>1</sup> This product is intended for use in nonresidential areas only. Use in residential areas may cause electromagnetic interference.
- <sup>2</sup> Emissions which exceed the levels required by this standard may occur when this equipment is connected to a test object.
- <sup>3</sup> For compliance with the EMC standards listed here, high quality shielded interface cables should be used.
- <sup>4</sup> Output voltage, current limit, and output state upon restoration of AC input power after a power interruption are determined by user preference settings. Under the factory default settings, output voltage and current limit values will be restored to the previous settings, but output state will be set to off. Change the user preferences if restoration of previous output state upon restoration of AC input power is desired.

### **Australia / New Zealand Declaration of Conformity – EMC**

Complies with the EMC provision of the Radiocommunications Act per the following standard, in accordance with ACMA:

- CISPR 11:2003. Radiated and Conducted Emissions, Group 1, Class A, in accordance with EN 61326-1:2006.

### **Australia / New Zealand contact.**

Baker & McKenzie  
Level 27, AMP Centre  
50 Bridge Street  
Sydney NSW 2000, Australia

## Safety Compliance

### EC Declaration of Conformity – Low Voltage

Compliance was demonstrated to the following specification as listed in the Official Journal of the European Communities:

Low Voltage Directive 2006/95/EC.

- EN 61010-1: 2001. Safety requirements for electrical equipment for measurement control and laboratory use.

### U.S. Nationally Recognized Testing Laboratory Listing

- UL 61010-1:2004, 2<sup>nd</sup> Edition. Standard for electrical measuring and test equipment.

### Canadian Certification

- CAN/CSA-C22.2 No. 61010-1:2004. Safety requirements for electrical equipment for measurement, control, and laboratory use. Part 1.

### Additional Compliances

- IEC 61010-1: 2001. Safety requirements for electrical equipment for measurement, control, and laboratory use.

### Equipment Type

Test and measuring equipment.

### Safety Class

Class 1 – grounded product.

### Pollution Degree Description

A measure of the contaminants that could occur in the environment around and within a product. Typically the internal environment inside a product is considered to be the same as the external. Products should be used only in the environment for which they are rated.

- Pollution Degree 1. No pollution or only dry, nonconductive pollution occurs. Products in this category are generally encapsulated, hermetically sealed, or located in clean rooms.
- Pollution Degree 2. Normally only dry, nonconductive pollution occurs. Occasionally a temporary conductivity that is caused by condensation must be expected. This location is a typical office/home environment. Temporary condensation occurs only when the product is out of service.
- Pollution Degree 3. Conductive pollution, or dry, nonconductive pollution that becomes conductive due to condensation. These are sheltered locations where neither temperature nor humidity is controlled. The area is protected from direct sunshine, rain, or direct wind.
- Pollution Degree 4. Pollution that generates persistent conductivity through conductive dust, rain, or snow. Typical outdoor locations.

## **Pollution Degree**

Pollution Degree 2 (as defined in IEC 61010-1). Note: Rated for indoor use only.

## **Installation (Overvoltage) Category Descriptions**

Terminals on this product may have different installation (overvoltage) category designations. The installation categories are:

- Measurement Category IV. For measurements performed at the source of low-voltage installation.
- Measurement Category III. For measurements performed in the building installation.
- Measurement Category II. For measurements performed on circuits directly connected to the low-voltage installation.
- Measurement Category I. For measurements performed on circuits not directly connected to MAINS.

## **Overvoltage Category**

Overvoltage Category II (as defined in IEC 61010-1)

## Environmental Considerations

This section provides information about the environmental impact of the product.

### Product End-of-Life Handling

Observe the following guidelines when recycling an instrument or component:

**Equipment recycling.** Production of this equipment required the extraction and use of natural resources. The equipment may contain substances that could be harmful to the environment or human health if improperly handled at the product's end of life. To avoid release of such substances into the environment and to reduce the use of natural resources, we encourage you to recycle this product in an appropriate system that will ensure that most of the materials are reused or recycled appropriately.



This symbol indicates that this product complies with the applicable European Union requirements according to Directives 2002/96/EC and 2006/66/EC on waste electrical and electronic equipment (WEEE) and batteries. For information about recycling options, check the Support/Service section of the Tektronix Web site ([www.tektronix.com](http://www.tektronix.com)).

### Restriction of Hazardous Substances

This product is classified as Monitoring and Control equipment, and is outside the scope of the 2002/95/EC RoHS Directive.

# Preface

## Key Features

The PWS2000 Series offer:

- Single-output, DC power
- 3-year warranty
- Linear regulation
- 0.05% Basic voltage accuracy
- 0.2% Basic current accuracy
- Less than 3 mV<sub>pp</sub> ripple and noise
- 20 user-defined setup memories

<b>Model</b>	<b>Description</b>
PWS2185	DC power supply. 18 V, 5 A, 1 channel
PWS2323	DC power supply. 32 V, 3 A, 1 channel
PWS2326	DC power supply. 32 V, 6 A, 1 channel
PWS2721	DC power supply. 72 V, 1.5 A, 1 channel



# Getting Started

## Standard Accessories

Accessory	Tektronix part number
<i>PWS2185, PWS2323, PWS2326, and PWS2721 Power Supply User Manual (available in 10 languages)</i> Contains safety and installation information.	071-2751-XX to 071-2760-XX
Power Cord: based upon the international power option	(See page 1, <i>Options and Optional Accessories</i> .)
Certificate of calibration	
PWS2000 Linear Power Supplies Documentation Browser CD	063-4282-XX

## Options and Optional Accessories

For the current list of accessories, upgrades, and options available for your PWS2000 Series Power Supply, visit the Tektronix Web site, [www.tektronix.com](http://www.tektronix.com).

**Table 1: Standard accessories**

Accessory	Tektronix part number
<i>PWS2185, PWS2323, PWS2326, and PWS2721 Power Supply Technical Reference</i> , in English. Contains detailed information about the instrument, including specifications and how to verify performance. Available for download from <a href="http://www.tektronix.com/manuals">www.tektronix.com/manuals</a> .	077-0482-XX
Power Cord	<i>One of the following:</i>
	North America (Option A0). The factory sets the 110V/220V selector switch to 110 V.
	Universal Euro (Option A1). The factory sets the 110V/220V selector switch to 220 V.
	United Kingdom (Option A2). The factory sets the 110V/220V selector switch to 220 V.
	Australia (Option A3). The factory sets the 110V/220V selector switch to 220 V.
	Switzerland (Option A5). The factory sets the 110V/220V selector switch to 220 V.
	China (Option A10). The factory sets the 110V/220V selector switch to 220 V.
	India (Option A11). The factory sets the 110V/220V selector switch to 220 V.
	Brazil (Option A12). The factory sets the 110V/220V selector switch to 220 V.

## Specifications

For more specifications, refer to the PWS2185, PWS2323, PWS2326, and PWS2721 Technical Reference.

**Table 2: Electrical ratings for the power connection**

Model	Line Selector Switch Setting	Frequency	Fuse Rating	Max Power
PWS2185	110 V / 220 V	50 / 60 Hz	For 110 V: 5 A TH, 250 V For 220 V: 2.5 A TH, 250 V	350 VA
PWS2323	110 V / 220 V	50 / 60 Hz	For 110 V: 5 A TH, 250 V For 220 V: 2.5 A TH, 250 V	350 VA
PWS2326	110 V / 220 V	50 / 60 Hz	For 110 V: 6.3 A TH, 250 V For 220 V: 3.15 A TH, 250 V	675 VA
PWS2721	110 V / 220 V	50 / 60 Hz	For 110 V: 5 A TH, 250 V For 220 V: 2.5 A TH, 250 V	350 VA

**Table 3: Environmental performance**

Parameter	PWS2185	PWS2323	PWS2326	PWS2721
Temperature	Operating: +0 °C to +40 °C			
Humidity	Operating: 5% to 95% relative humidity (% RH) at up to +40 °C, non-condensing			
Altitude	Operating: 100% capability up to 2,000 meters			
Pollution Degree 2, For indoor use only				

### Nominal Voltage Ratings

There are two ranges for all models, selectable by the line-voltage selector switch. Check the voltage select switch on the bottom before turning on: 110 V setting, 110 / 115 / 120 VAC; 220 V setting, 220 / 230 / 240 VAC. Fluctuations must not exceed 10% of the nominal rated voltage.

### Float Voltage Rating

Float voltage rating: up to 100 V (DC + peak AC) between earth ground and any output terminal.

## Operating Requirements

1. Place the instrument on a bench or similar surface.
2. Before operating, ensure that the ambient temperature is between +0 °C and +40 °C (+32 °F to +104 °F).



**WARNING.** To ensure proper cooling, keep the front, sides, and rear of the instrument clear of obstructions. Do not operate the instrument on a table without the handle in the down and locked position. This allows air flow to the bottom of the instrument.



---

**WARNING.** Observe all safety precautions listed in this manual before using this product and any associated instruments. Although some instruments and accessories would be used with non-hazardous voltages, there are situations where hazardous conditions may be present. This product is intended for use by qualified personnel who recognize shock hazards and are familiar with the safety precautions required to avoid possible injury. Read and follow all installation, operation, and maintenance information carefully before using the product. Refer to this manual for complete product specifications. Before performing any maintenance, disconnect the line cord and all test cables. Operators of this instrument must be protected from electric shock at all times. The responsible body must ensure that operators are prevented access and/or insulated from every connection point. In some cases, connections must be exposed to potential human contact. Product operators in these circumstances must be trained to protect themselves from the risk of electric shock. If the circuit is capable of operating at or above 1000 volts, no conductive part of the circuit may be exposed.

---



---

**WARNING.** Use properly rated load wires. All load wires must be heavy enough not to overheat when carrying the maximum short-circuit output current of the power supply. If there is more than one load, then any pair of load wires must be capable of safely carrying the full-rated short-circuit output current of the power supply.

---



---

**WARNING.** Do not loosen any screw on this product. There are no user serviceable components inside.

---



---

**WARNING.** To reduce risk of fire and shock, ensure the mains supply voltage fluctuations do not exceed 10% of the operating voltage range.

---

## Installing the System

This section contains information on how to install your PWS2000 power supply.

- Unpack the instrument and check that you received all the items listed as standard accessories.
- Check that you also received any other accessories that you ordered with your instrument.
- Check the Tektronix Web site ([www.tektronix.com](http://www.tektronix.com)) for the most current information.

To verify that the power supply is ready to use, follow these procedures:

### Powering the Instrument On and Off

To power on the instrument follow these steps:

1. Make all the connections.
2. Properly set the 110 V / 220 V selector switch on the bottom of the instrument.

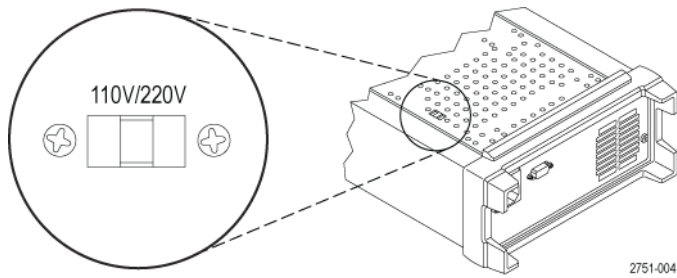

3. Connect the power cord that was provided with the instrument to the power connector on the rear panel. Connect the power cord plug to a properly grounded electrical outlet.
4. Push the power button on the front panel.

To power off the instrument, push the front panel power button.



---

**WARNING.** To satisfy safety requirements, always use load wires heavy enough not to overheat when carrying the maximum short-circuit output current of the power supply. If there is more than one load, then every pair of load wires must be capable of safely carrying the full-rated current of the power supply.

---

### What to Do if the Power Supply Does Not Turn On

To solve problems you might encounter when turning on the instrument, follow these steps:

1. Verify that there is AC power to the power supply.

First, check that the AC power cord is firmly plugged into the power connector on the rear panel of the power supply. You should also make sure that the AC power source you plugged the power supply into is energized. Then, check that the power supply is turned on.

2. Verify the power-line voltage settings.

Check that the line voltage selector switch on the bottom of the instrument is set to the proper value for your country (110 V<sub>AC</sub> or 220 V<sub>AC</sub>). Change the voltage setting if it is not correct.

---

**NOTE.** Under certain circumstances, powering the instrument from a mains voltage for which it is not configured can cause the mains fuse to open.

---

3. Verify that the correct power-line fuse is installed.

If the fuse is damaged, replace the fuse for your power supply.

If you set the line selection to 110 V, use a 5 A, TH 250 V fuse.

If you set the line selection to 220 V, use a 2.5 A, TH 250 V fuse.

4. If you need more help, contact Tektronix.

## Check the Output

The following procedures check that the power supply develops its rated outputs and properly responds to operation from the front panel.

**Voltage output check.** To verify basic voltage functions without a load, follow these steps.

1. Remove all leads from the output connectors.
2. Turn on the power supply.
3. Push **Menu** to bring up the **Reset All** menu. This menu allows you to set the instrument to default settings.
4. Push **Enter**.
5. Push the up arrow button to select **Yes**. Push **Enter** to restore the default settings.
6. Push the output **On/Off** button to enable the output. The **OFF** message above and to the left of the voltage display will turn from **Off** to **CV**. The meter indicator should be lit and the meter readings should show 1 V and 0 A.
7. Check that the front-panel voltmeter properly responds to the number keys.

Push **V-set**, use the number keys to set the voltage value to 0 and push **Enter**. Check if the displayed voltage value is approximately 0 V and check if the displayed current value is approximately 0 A. You can confirm the 0 V setting with a voltmeter.

8. Push **V-set** and use the numeric keys and **Enter** button to set the voltage value to the maximum allowable for your power supply, as indicated on the front panel of the unit.
9. Check if the displayed voltage value is approximately the same value as the voltage setting.

**Current output check.** To verify the basic current functions with a short across the power supply output, follow these steps:

1. Remove all leads from the output connectors.
2. Turn on the power supply.
3. Push **Menu** to bring up the **Reset All** menu. This menu allows you to set the instrument to default settings.
4. Push **Enter**.
5. Push the up arrow button to select **Yes**. Push **Enter** to enable the default settings.
6. Ensure that the output is disabled and the display **OFF** message is turned on. If needed, push the output **On/Off** button.
7. Use an insulated test lead to connect a short across the (+) and (-) output terminals.

Use a wire size sufficient to handle the maximum current. You should use at least a 22 gauge wire.



**WARNING.** To satisfy safety requirements, always use load wires heavy enough not to overheat when carrying the maximum short-circuit output current of the power supply. If there is more than one load, then every pair of load wires must be capable of safely carrying the full-rated current of the power supply.

8. Push the output **On/Off** button to enable the output. The **CC** message should be lit.
9. Push **I-set** and use the numeric keys and **Enter** button to set the current value to 0 A. Check if the displayed current value is approximately 0 A.

10. Push **I-set** and use the numeric keys and **Enter** button to set the current value to the maximum allowable for your current supply. Check if the displayed current value is approximately the same value as the maximum allowable.
11. Turn off the power supply and remove the short wire from the (+) and (-) output terminals.

## Cleaning

Inspect the power supply as often as operating conditions require. To clean the exterior surface, perform the following steps:

1. Remove loose dust on the outside of the power supply with a lint-free cloth. Use care to avoid scratching the display.
2. Use a soft cloth dampened with water to clean the power supply. Use an aqueous solution of 75% isopropyl alcohol for more efficient cleaning.



**CAUTION.** *To avoid damage to the surface of the power supply, do not use any abrasive or chemical cleaning agents.*

---



**CAUTION.** *Avoid getting moisture inside the unit during external cleaning. Use only enough cleaning solution to dampen the cloth or swab.*

---

# Operating Basics

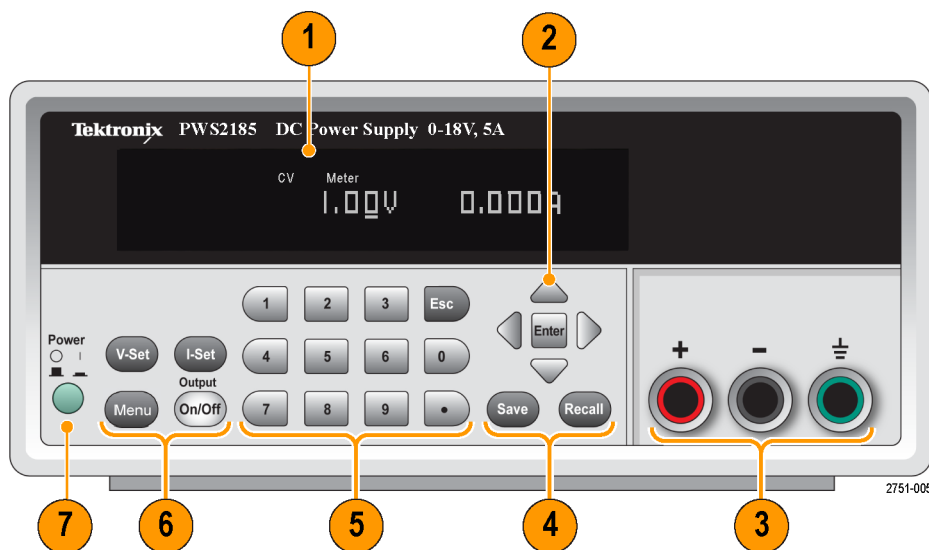

## Front Panel at a Glance

Controls and display elements are shown in the following illustrations and tables.







1. Display containing information about the settings or output for voltage (left) and current (right)
2. Up, down, right, and left arrow keys (▲ and ▼) and **Enter** button
3. Output connectors
4. **Save** and **Recall** function buttons
5. Number keys (0 to 9 and **Esc**) for direct numeric entry
6. **V-Set**, **I-Set**, **Menu**, and **Output On/Off** function buttons
7. Power button

### Function button descriptions

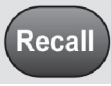
Button	Description
	Sets the voltage limit
	Sets the current limit
	Saves the present settings to a specified setup memory location (1 to 20). Select the memory location with the multipurpose knob, the up or down arrow keys, or the numeric keypad. The power supply saves the settings after you push <b>Enter</b> .

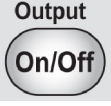
### Function button descriptions (cont.)

Button	Description
	Recalls a saved setting from a specified setup memory location (1 to 20). Select the memory location with the multipurpose knob, the up or down arrow keys, or the numeric keypad. The power supply recalls the settings after you push <b>Enter</b> .
	Use to access the following power supply settings: Reset All, Max Volt, Key Lock, Out Recall, Save Last, Key Beep, and Sys Info. Push <b>Enter</b> to select the displayed menu item.
	Turns on or off the output channel of the power supply. The regulation mode, constant voltage (CV) or constant current (CC), is shown on the display when the output is turned on.
	Backs out of the selected function. If the instrument's focus is in a menu, pushing <b>Esc</b> will back up one menu level.

### Menu button descriptions

Primary Menu	Secondary Menu	Description
Reset All		Returns the instrument to the factory default setup values.
	Yes	Select to return the instrument to the factory default setup values and then press the <b>Enter</b> button
	No	Select if you do not want to return the instrument to the factory default setup values and then press the <b>Enter</b> button
Max Volt		Sets the maximum output voltage value to which you can set the instrument
Key Lock		When activated, this feature locks the front panel controls and prompts for a password to enable settings changes. This feature does not lock the power switch or the output on/off switch.
Out Recall	On (Def)	Sets the power output On/Off state after power up. "On" restores the state to that which was in use before the power was last turned off. "Off" disables this function and configures the output channel to power up on the off state.
	Off	
Save Last	On (Def)	Recalls the operating parameters of the power supply after power up. It does this by saving the last setting of operating parameters before you turn the instrument off and then restoring the saved setting when you turn the instrument back on.  <i><b>NOTE.</b> Wait 3 seconds after changing the settings to allow the settings to be completely stored before powering off the instrument</i>
	Off	
Key Beep		Turns on or off a beeper sound when you push a button or press a key. "On" enables the key sound. "Off" disables it.
Sys Info		Provides instrument information including model number, serial number, and software version.

### Display messages

Symbol	Description
OFF	The power supply output is off



**Display messages (cont.)**

Symbol	Description
<b>CV</b>	Constant voltage mode
<b>CC</b>	Constant current mode
<b>Meter</b>	The Volt meter display is active
<b>Lock</b>	Front panel controls are locked. Enter password to unlock.

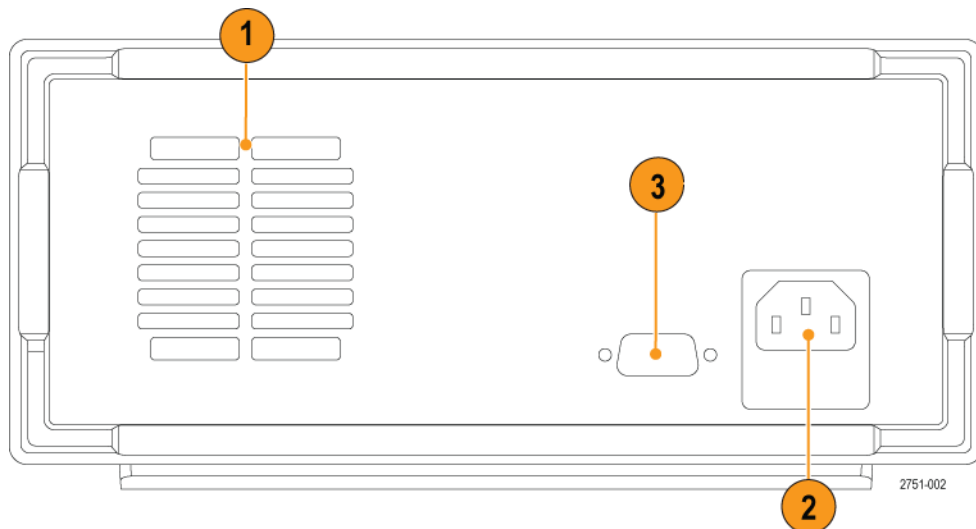
**Rear Panel at a Glance**

1. Cooling vents
2. 110 V/220 V power connector
3. Factory test port



**CAUTION.** *Unauthorized use of the factory test port could damage this product.*

4. 110 V/220 V selector switch

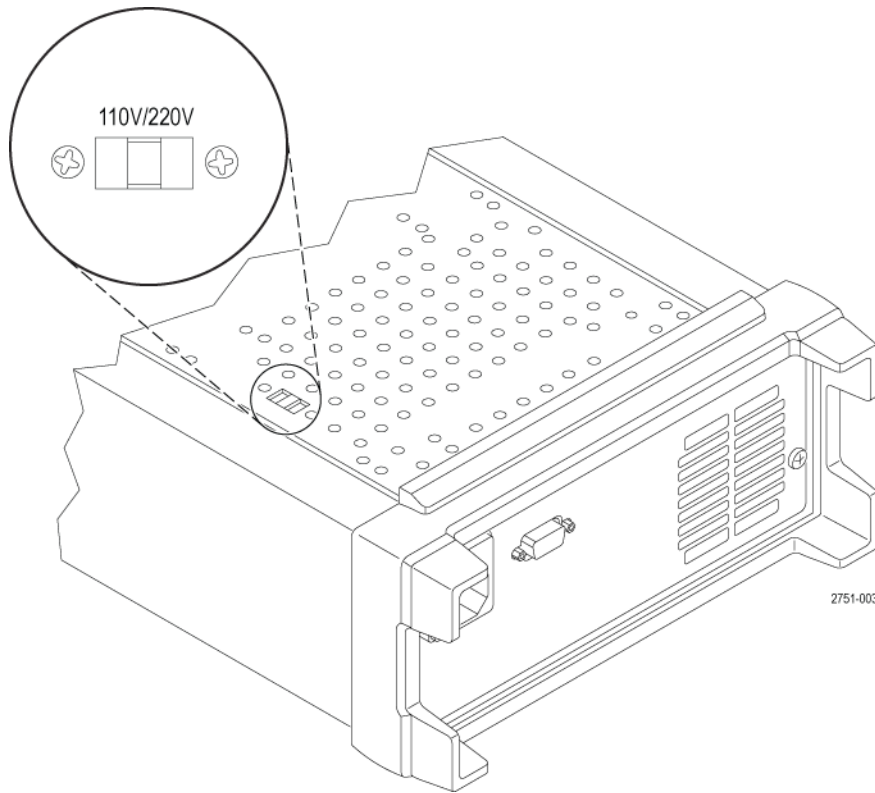

## Front-panel Operation

Within a few seconds after powering on, the power supply goes into **Meter** mode. It displays the actual voltage and current output value. To see the voltage or current limits, press the **Enter** button. Pressing the **V-Set** or **I-Set** button puts the meter into **Set** mode. Both voltage and current limit settings will show, but either the voltage or current setting will flash to indicate which parameter can be adjusted. The settings will continue to show until the power supply returns to **Meter** mode. Press the up and down arrow keys to adjust the selected limit. The power supply automatically goes from **Set** mode to **Meter** mode if you do not press any key for 3 seconds.

You can enable or disable the output of the power supply from the front panel by pushing the **Output On/Off** button. When the output is off, the **OFF** message will appear on the display above the current and voltage values.

The display shows the present operating status of the power supply with display messages. When the power supply operates in constant voltage mode, the **CV** message displays above the voltage. When it operates in the constant current mode, the **CC** message displays above the voltage.

---

**NOTE.** If the front panel was locked with a password, enter the correct password after you push one of the front panel buttons, then you can change the settings.

---



---

**NOTE.** To cancel a function operation (**V-set**, **I-set**, **Save**, and **Recall**), push the **Esc** button.

---

## Configuring the Instrument for Your Application

The menu system includes settings like **Max Volt** that determines the maximum voltage output of the power supply and settings, like **Out Recall** and **Save Last**, that determine how the instrument initializes itself on power-up.

This power supply features a constant voltage/constant current automatic crossover. This feature permits continuous operation in the transition from constant-voltage mode to constant-current mode as the load changes. The intersection of the constant-current and constant-voltage modes is called the crossover point.

For example, if the load is such that the power supply is operating in constant-voltage mode, the power supply provides a regulated output voltage. The output voltage remains constant as the load increases until the preset current limit is reached. Then the crossover occurs. At that point, the output current becomes constant and the output voltage drops in proportion to further load increases.

Crossover is indicated by the front panel **CC** and **CV** messages. If the **CV** message appears, the instrument is operating in constant-voltage mode. If the **CC** message appears, the instrument is operating in constant-current mode.

Crossover from the constant-current mode to the constant-voltage mode also occurs automatically in response to a decrease in load. For example, suppose you are charging a 12 V battery. Initially, the open circuit voltage of the power supply is preset for 13.8 V. A low-battery places a heavy load on the power supply, and it operates in constant-current mode. You adjust the instrument to charge the battery at the rate of 1 A. As the battery becomes charged and its voltage approaches 13.8 V, the load decreases to the point where the battery no longer demands the full 1 A charging rate. The power supply then crosses over to constant-voltage mode.

## Initializing to the Default Setup

Use the default setup to get the power supply into a default initial state.

1. Remove all leads from the output connectors.
2. Turn on the power supply.
3. Push **Menu** to bring up the **Reset System** menu. This menu allows you to set the instrument to default settings.
4. Push **Enter**.
5. Push the up arrow button to select **Yes** and push **Enter** to enable the default settings.

The default settings are:

- **Output On/Off = OFF**
- **V-Set = 1.000V**
- **I-Set = 0.1000A**
- **Max Volt Set = Off**
- **Save Last = On**
- **Out Recall = On**
- **Key Beep = Off**

### Setting the Current Limit (I-Set)

You may set the current limit from 0 A to the maximum current value of each model. The maximum current rating is shown on the instrument name plate.

1. Push **I-Set**.
2. Use the numeric keys and push **Enter** to set the current limit. You can also use the up, down, right, and left arrow keys.

### Setting the Voltage Limit (V-Set)

You may set the voltage limit from 0 V to the maximum voltage rating shown on the instrument nameplate.

1. Push **V-set**.
2. Use the numeric keys and push **Enter** to set the voltage limit. You can also use the up, down, right, and left arrow keys.

### Save and Recall Setups (SAVE and RECALL)

You can store up to 20 different setups in setup memory locations (1 to 20). Each setup includes the set voltage limit, the set current limit, and the maximum output voltage value. When shipped from the factory, setup memories 1 through 20 are empty. Save and recall setups as follows:

#### Saving setups.

1. After you set up the power supply (voltage limit, current limit, and the maximum output voltage) push the **Save** button.
2. Use the number keys or the arrow keys to select the setup memory (1 to 20) that you want to store the values in.
3. Push **Enter** to confirm the memory location.

#### Recalling setups.

1. Push **Recall**.
2. Use the number keys or the arrow keys to select the setup that you want to recall.
3. Push **Enter**.

### Set the Maximum Voltage (>MAX VOLT)

This control determines the maximum voltage that you can set using the **V-set** control. This can help keep accidental over-voltage from being applied to sensitive loads. To set the maximum voltage, follow these steps:

1. Push **Menu**.
2. Use the down arrow key to select **Max Volt**.
3. Push **Enter** and use the number keys to enter the voltage value.
4. Push **Enter** to turn on the maximum voltage feature. **Limit Done** should appear briefly and then **Max Volt** will appear.
5. Push **Esc** to exit the menu.
6. Push **V-Set**.
7. Use the numeric keys or the arrow keys to change the voltage value. The value must be less than the maximum voltage output.

8. Push **Enter**.
9. Push **Esc** to exit the menu system.

---

**NOTE.** The default maximum voltage is the full voltage range of the particular power supply being used.

---

### Recall the Power Supply ON/OFF Output State at Power On (>OUT RECALL)

This parameter determines the initial On or Off output state after the power supply is powered on. If you select **On**, the power supply will restore the state of the output to that which was in use before the power was last turned off. If the output was turned **On** when the power supply is turned off or loses power then the output will return to the **On** state when the power supply is turned back on or power is restored. **Off** will disable this function and the output channel will always be set to **Off** after the power supply is powered on.

To enable or disable this control,

1. Push the **Menu**.
2. Use the down arrow key to select **OUT RECALL**.
3. Push **Enter**.
4. Use the up arrow key to select **On** or **Off**.
5. Push **Enter**.
6. Push **Esc** to exit the menu system.

---

**NOTE.** The default selection is set to *Off*.

---

### Recall the Power Supply Operating Parameters at Power On (>SAVE LAST)

This parameter determines whether the power supply saves its most recent settings, such as voltage and current, and restores these settings at power on. If you set this parameter to **Off** then the power supply returns to the default settings at power on. If you select **On**, the power supply will restore the state to that which was in use before the power was last turned off.

To enable or disable this control,

1. Push **Menu**.
2. Use the down arrow key to select **Save Last**.
3. Push **Enter**.
4. Use the arrow keys to select **On** or **Off**.
5. Push **Enter**.
6. Push **Esc** to exit the menu system.

---

**NOTE.** The default selection is set to *On*.

---

### Set the Key Beep (>KEY BEEP)

This control can switch on or off the sound that occurs when you push any button or press any key. To enable or disable this feature,

1. Push **Menu**.
2. Use the down arrow key to select **Key Beep**.
3. Push **Enter**.
4. Use the arrow keys to select **On** or **Off**.
5. Push **Enter**.
6. Push **Esc** to exit the menu system.

---

**NOTE.** *The default selection is set to Off.*

---

# Index

## Symbols and Numbers

110 V/220 V selector switch, 10

## A

Accessories  
     optional, 1  
     standard, 1

## B

Button  
     I-set, 7  
     Menu, 8  
     On/off, 8  
     Recall, 8  
     Save, 7  
     V-set, 7

## C

Checkout  
     current, 5  
     no power, 4  
     voltage, 5  
 Connectors, 7  
 Crossover, 11  
 Current display, 7  
 Current limit adjustment, 12

## D

Display, 7  
     messages, 8

## F

Features, x  
 Front panel, 10  
 Front panel indicators and buttons, 7

Function button

    I-set, 7  
     Menu, 8  
     On/off, 8  
     Recall, 8  
     Save, 7  
     V-set, 7

## I

I-set button, 7  
 Initial output, 13  
 Installation, 3

## K

Key  
     arrow, 7  
     function, 7  
     number, 7  
     Save and Recall, 7  
 Key Beep, 14

## M

Max Volt Set, 12  
 Menu button, 8  
 Messages, 8

## N

No power, 4

## O

On/off button, 8  
 Operating requirements, 2  
 Operation  
     current limit adjustment, 12  
     recalling setups, 12  
     saving setups, 12  
     voltage limit adjustment, 12  
 Optional accessories, 1  
 Options, 1

Output

    Display, 7  
 Output recall, 13

## P

Power  
     button, 7  
     off, 4  
     on, 3  
     socket, 9

## R

Rear panel, 9  
 Recall button, 8  
 Recall output, 13  
 Requirements  
     operating, 2

## S

Safety Summary, iii  
 Save  
     Button, 7  
     Last, 13  
 Saving and recalling setups, 12  
 Setting  
     current limit, 12  
     voltage limit, 12  
 Settings display, 7  
 Specifications, 2  
 Standard accessories, 1

## T

Troubleshooting, 4

## V

V-set button, 7  
 Voltage limit adjustment, 12  
 Volts display, 7