

Series 2400

SourceMeter® Line



S J ELECTRONICS
POWER • TEST & MEASUREMENT

0800 583 44 55

Tel: +44 1536 416 200

Fax: 0800 583 55 66

sales@sjelectronics.co.uk

www.sjelectronics.co.uk



Keithley's SourceMeter family is designed specifically for test applications that demand tightly coupled sourcing and measurement. All SourceMeter models provide precision voltage and current sourcing as well as measurement capabilities. Each SourceMeter instrument is both a highly stable DC power source and a true instrument-grade 5½-digit multimeter. The power source characteristics include low noise, precision, and readback. The multimeter capabilities include high repeatability and low noise. The result is a compact, single-channel, DC parametric tester. In operation, these instruments can act as a voltage source, a current source, a voltage meter, a current meter, and an ohmmeter. Manufacturers of components and modules for the communications, semiconductor, computer, automotive, and medical industries will find the SourceMeter instruments invaluable for a wide range of characterization and production test applications.

Advantages of a Tightly Integrated Instrument

By linking source and measurement circuitry in a single unit, these instruments offer a variety of advantages over systems configured with separate source and measurement instruments. For example, they minimize the time required for test station development, setup, and maintenance, while lowering the overall cost of system ownership. They simplify the test process itself by eliminating many of the complex synchronization and connection

issues associated with using multiple instruments. And, their compact half-rack size conserves precious "real estate" in the test rack or bench.

The Power of Three Instruments in One

The tightly coupled nature of a SourceMeter instrument provides many advantages over separate instruments. For example, it provides faster test times by reducing GPIB traffic and simplifies the remote programming interface. It also protects the device under test from damage due to accidental overloads, thermal runaway, etc. Both the current and voltage source are programmable with readback to help maximize device measurement integrity. If the readback reaches a programmed compliance limit, then the source is clamped at the limit, providing fault protection.

- Family of products offers wide dynamic range: 10pA to 10A, 1µV to 1100V, 20W to 1000W
- 4-quadrant operation
- 0.012% basic accuracy with 5½-digit resolution
- 6-wire Ω measurement with programmable I source and V clamp
- 1700 readings/second at 4½ digits via GPIB
- Built-in comparator for fast pass/fail testing
- Optional contact check function
- Digital I/O for fast binning and connection to component handlers
- GPIB, RS-232, and Trigger Link interfaces
- TestPoint™ and LabVIEW® drivers

ACCESSORIES AVAILABLE

TEST LEADS AND PROBES

1754	2-Wire Universal 10-Piece Test Lead Kit
5804	Kelvin (4-Wire) Universal 10-Piece Test Lead Kit
5805	Kelvin (4-Wire) Spring-Loaded Probes
5806	Kelvin (4-Wire) Clip Lead Set
8607	2-Wire, 1000V Banana Cables, 1m (3.3 ft)
CA-18-1	Shielded Dual Banana Cable, 1.2m (4 ft)

SWITCHING HARDWARE

7001	Two-Slot Switch System
7002	Ten-Slot Switch System
7019-C	6-Wire Ohms Switch Card
7053	High-Current Switch Card

CABLES/ADAPTERS

7007-1	Shielded GPIB Cable, 1m (3.3 ft)
7007-2	Shielded GPIB Cable, 2m (6.6 ft)
7009-5	RS-232 Cable

COMMUNICATION INTERFACE

KPCI-488LP	IEEE-488 Interface/Controller for the PCI Bus
KPXI-488	IEEE-488 Interface Board for the PXI Bus
KUSB-488A	IEEE-488 USB-to-GPIB Interface Adapter

TRIGGERING AND CONTROL

2499-DIGIO	Digital I/O Expander Assembly
8501-1	Trigger Link Cable, DIN-to-DIN, 1m (3.3 ft)
8501-2	Trigger Link Cable, DIN-to-DIN, 2m (6.6 ft)
8502	Trigger Link to BNC Breakout Box
8503	Trigger Link Cable, DIN-to-Dual BNC, 1m (3.3 ft)
8505	Male to 2-Female Y-DIN Cable for Trigger Link

RACK MOUNT KITS

4288-1	Single Fixed Rack Mount Kit
4288-2	Dual Fixed Rack Mount Kit

SOFTWARE

LabTracer 2.0	Curve Tracing Software (downloadable)
---------------	---------------------------------------

Tightly coupled precision sourcing and measurement

SOURCE AND MEASURE

1.888.KEITHLEY (U.S. only)

www.keithley.com

KEITHLEY

Series 2400

SourceMeter® Line

Ordering Info

2400	200V, 1A, 20W SourceMeter
2400-C	200V, 1A, 20W SourceMeter with Contact Check
2400-LV	20V, 1A, 20W SourceMeter
2410	1100V, 1A, 20W SourceMeter
2410-C	1100V, 1A, 20W SourceMeter with Contact Check
2420	60V, 3A, 60W SourceMeter
2420-C	60V, 3A, 60W SourceMeter with Contact Check
2425	100V, 3A, 100W SourceMeter
2425-C	100V, 3A, 100W SourceMeter with Contact Check
2430	100V, 10A, 1000W Pulse Mode SourceMeter
2430-C	100V, 10A, 1000W Pulse Mode SourceMeter with Contact Check
2440	40V, 5A, 50W SourceMeter
2440-C	40V, 5A, 50W SourceMeter with Contact Check

Accessories Supplied

Test Leads
 LabVIEW Software Driver (downloadable)
 LabTracer Software (downloadable)
 TestPoint Software Driver (downloadable)

I-V Characteristics

All SourceMeter instruments provide four-quadrant operation. In the first and third quadrants they operate as a source, delivering power to a load. In the second and fourth quadrants they operate as a sink, dissipating power internally. Voltage, current, and resistance can be measured during source or sink operation.

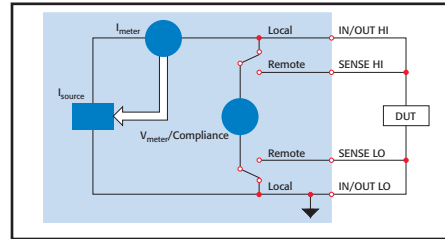

Source I, Measure V, I, or Ω configuration

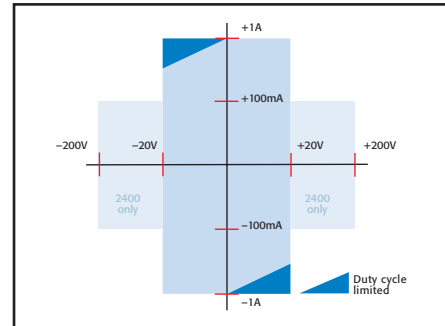

Model 2400 and 2400-LV SourceMeter

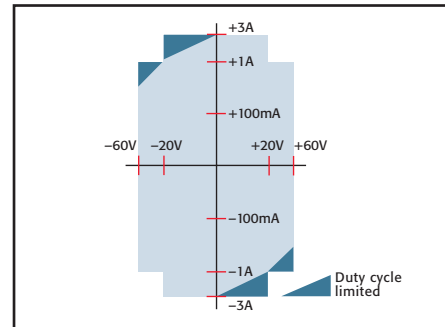

Model 2420 3A SourceMeter

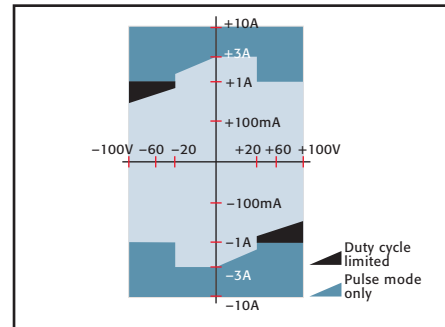

Model 2430 1kW Pulse Mode SourceMeter

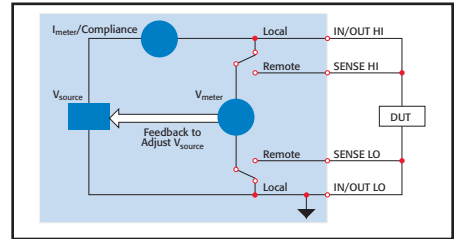

Source V, Measure I, V, or Ω configuration

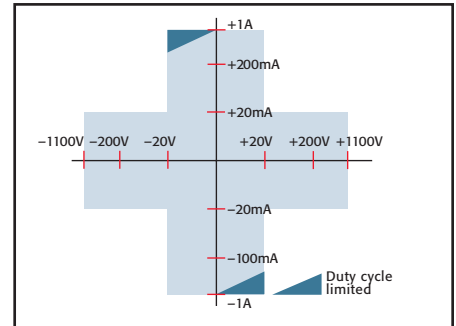

Model 2410 High-Voltage SourceMeter

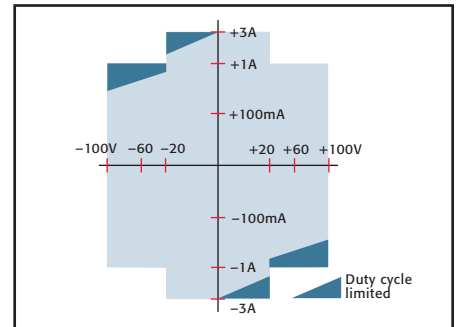

Model 2425 100W SourceMeter

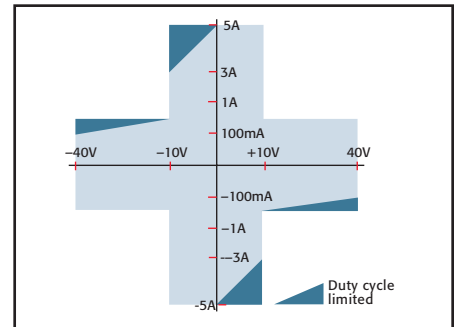

Model 2440 5A SourceMeter

Automation for Speed

A SourceMeter instrument streamlines production testing. It sources voltage or current while making measurements without needing to change connections. It is designed for reliable operation in non-stop production environments. To provide the throughput demanded by production applications, the SourceMeter instrument offers many built-in features that allow it to run complex test sequences without computer control or GPIB communications slowing things down.

Standard and Custom Sweeps

Sweep solutions greatly accelerate testing with automation hooks. Three basic sweep waveforms are provided that can be programmed for single-event or continuous operation. They are ideal for I/V, I/R, V/I, and V/R characterization.

- Linear Staircase Sweep: Moves from the start level to the stop level in equal linear steps
- Logarithmic Staircase Sweep: Done on a log scale with a specified number of steps per decade
- Custom Sweep: Allows construction of special sweeps by specifying the number of measurement points and the source level at each point
- Up to 1700 readings/second at 4½ digits to the GPIB bus
- 5000 5½-digit readings can be stored in the non-volatile buffer memory

Built-In Test Sequencer (Source Memory List)

The Source Memory list provides faster and easier testing by allowing you to setup and execute up to 100 different tests that run without PC intervention.

- Stores up to 100 instrument configurations, each containing source settings, measurement settings, pass/fail criteria, etc.
- Pass/fail limit test as fast as 500µs per point
- Onboard comparator eliminates the delay caused when sending data to the computer for analysis
- Built-in, user definable math functions to calculate derived parameters

Example Test Sequence

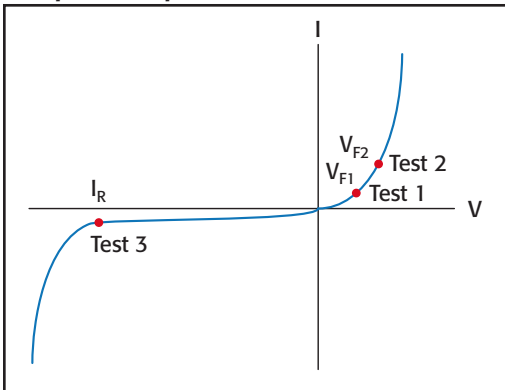

Test	Pass/Fail Test	If Passes Test	If Fails Test
Test 1	Check V_{F1} at 100mA against pass/fail limits	Go to Test 2	1. Bin part to bad bin 2. Transmit data to computer while handler is placing new part 3. Return to Test 1
Test 2	Check V_{F2} at 1A against pass/fail limits	Go to Test 3	
Test 3	Check leakage current at -500V and test against pass/fail limits	1. Bin part to good bin 2. Transmit readings to computer while handler is placing new part 3. Return to Test 1	

TYPICAL APPLICATIONS

Devices:

- Discrete semiconductor devices
- Passive devices
- Transient suppression devices
- ICs, RFICs, MMICs
- Laser diodes, laser diode modules, LEDs, photodetectors
- Circuit protection devices: TVS, MOV, Fuses, etc.
- Airbags
- Connectors, switches, relays

Tests:

- Leakage
- Low voltage/resistances
- LIV
- IDDQ
- I-V characterization
- Isolation and trace resistance
- Temperature coefficient
- Forward voltage, reverse breakdown, leakage current
- DC parametric test
- DC power source
- HIPOT
- Dielectric withstanding

Series 2400

SourceMeter® Line

Digital I/O Interface

The digital I/O interface can link the SourceMeter instrument to many popular component handlers, including Aetrium, Aeco, and Robotronics. Other capabilities of the interface include:

- Tight systems integration for applications such as binning and sorting
- Built-in component handler interface
- Start of test and end of test signals
- 5V, 300mA power supply
- Optional expander accessory (Model 2499-DIGIO) adds 16 digital I/O lines

Trigger Link Interface

All SourceMeter instruments include Keithley's unique Trigger Link interface which provides high-speed, seamless communications with many of Keithley's other instruments. For example, use the Trigger Link interface to connect a SourceMeter instrument with a Series 7000 Switching System for a complete multi-point test solution. With Trigger Link, the 7000 Series Switching Systems can be controlled by a SourceMeter during a high-speed test sequence independent of a computer and GPIB.

Optional Contact Check Function

The Contact Check function makes it simple to verify good connections quickly and easily before an automated test sequence begins. This eliminates measurement errors and false product failures associated with contact fatigue, breakage, contamination, loose or broken connection, relay failures, etc. Some capabilities of this function are:

- 350 μ s verification and notification process time
- The output of the SourceMeter instrument is automatically shut off after a fault and is not re-activated until good contact is verified, protecting the device under test from damage and the operator from potential safety hazards
- 3 pass/fail threshold values: 2 Ω , 15 Ω , and 50 Ω
- No energy passes through the device under test during the operation
- Enabled either from the front panel or remotely over the GPIB
- 3 fault notification methods

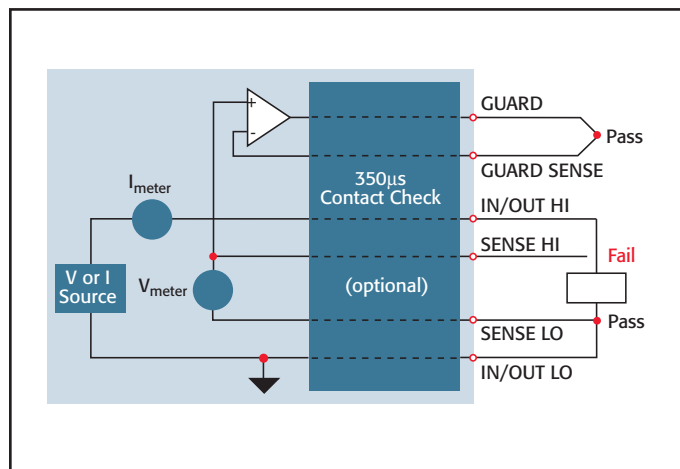

Contact check option for 4-wire or 6-wire applications

Unique 6-Wire Ohms Technique

SourceMeter instruments can make standard 4-wire, split Kelvin, and 6-wire, guarded ohms measurements and can be configured for either the constant current or constant voltage method. The 6-wire ohms technique:

- Uses guard and guard sense leads in addition to the 4-wire sense and source leads
- Locks out parallel current paths when measuring resistor networks or hybrid circuits to isolate the component under test
- Allows users to configure and plot data easily from Series 2400 SourceMeter instruments, making characterization of two, three, and four terminal devices a snap

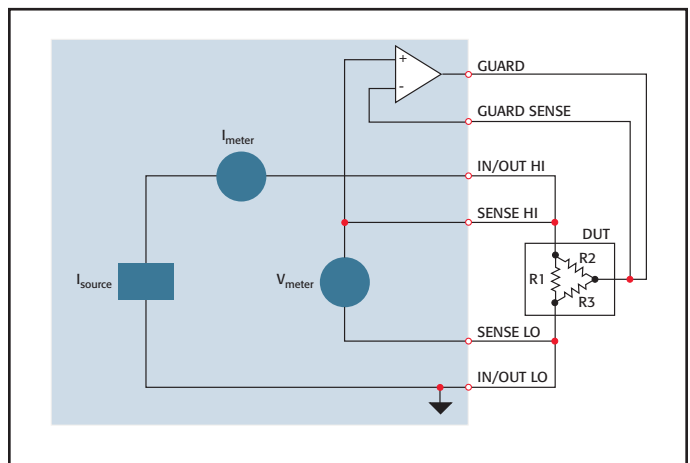

6-Wire Ohms Circuit. All test current flows through R1 because the high current guard drives the voltage across R2 to 0V.

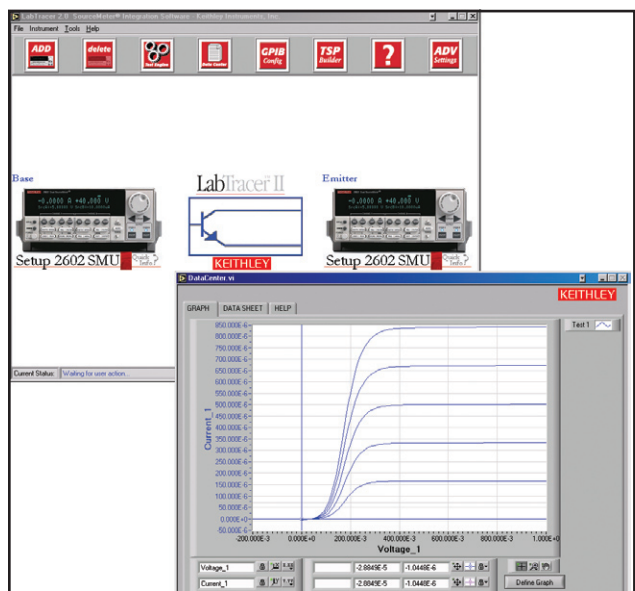

Free LabTracer 2.0 device characterization software (downloadable)

Voltage Accuracy (Local or Remote Sense)

Model	Range	Programming Resolution	Source ¹ Accuracy (1 Year) 23°C ±5°C ±(% rdg. + volts)	Default Measurement Resolution	Measurement ^{2,3,4} Accuracy (1 Year) 23°C ±5°C ±(% rdg. + volts)	Output Slew Rate (±30%)	Source/Sink Limit
2400, 2400-C	200.000 mV	5 μV	0.02% + 600 μV	1 μV	0.012% + 300 μV		
	2.00000 V	50 μV	0.02% + 600 μV	10 μV	0.012% + 300 μV		±21 V @ ±1.05 A
	20.0000 V	500 μV	0.02% + 2.4 mV	100 μV	0.015% + 1.5 mV	0.08 V/μs	±210 V @ ±105 mA
	200.000 V	5 mV	0.02% + 24 mV	1 mV	0.015% + 10 mV	0.5 V/μs	
2400-1V	200.000 mV	5 μV	0.02% + 600 μV	1 μV	0.012% + 300 μV		
	2.00000 V	50 μV	0.02% + 600 μV	10 μV	0.012% + 300 μV		±21 V @ ±1.05 A
	20.0000 V	500 μV	0.02% + 2.4 mV	100 μV	0.015% + 1.5 mV	0.08 V/μs	
2410, 2410-C	200.000 mV	5 μV	0.02% + 600 μV	1 μV	0.012% + 300 μV		
	2.00000 V	50 μV	0.02% + 600 μV	10 μV	0.012% + 300 μV		±21 V @ ±1.05 A
	20.0000 V	500 μV	0.02% + 2.4 mV	100 μV	0.015% + 1 mV	0.15 V/μs	±1100 V @ ±21 mA
	100.000 V	50 mV	0.02% + 100 mV	10 mV	0.015% + 50 mV	0.5 V/μs	
2420, 2420-C	200.000 mV	5 μV	0.02% + 600 μV	1 μV	0.012% + 300 μV		
	2.00000 V	50 μV	0.02% + 600 μV	10 μV	0.012% + 300 μV		±21 V @ ±3.15 A
	20.0000 V	500 μV	0.02% + 2.4 mV	100 μV	0.015% + 1 mV	0.08 V/μs	±63 V @ ±1.05 A
	60.0000 V	1.5 mV	0.02% + 7.2 mV	1 mV	0.015% + 3 mV	0.14 V/μs	
2425, 2425-C	200.000 mV	5 μV	0.02% + 600 μV	1 μV	0.012% + 300 μV		
	2.00000 V	50 μV	0.02% + 600 μV	10 μV	0.012% + 300 μV		±21 V @ ±3.15 A
	20.0000 V	500 μV	0.02% + 2.4 mV	100 μV	0.015% + 1 mV	0.08 V/μs	±105 V @ ±1.05 A
	100.0000 V	2.5 mV	0.02% + 12 mV	1 mV	0.015% + 5 mV	0.25 V/μs	
2430, 2430-C	200.000 mV	5 μV	0.02% + 600 μV	1 μV	0.012% + 300 μV		
	2.00000 V	50 μV	0.02% + 600 μV	10 μV	0.012% + 300 μV		±105 V @ ±1.05 A
	20.0000 V	500 μV	0.02% + 2.4 mV	100 μV	0.015% + 1 mV	0.08 V/μs	±105 V @ ±10.5 A
	100.0000 V	2.5 mV	0.02% + 12 mV	1 mV	0.015% + 5 mV	0.25 V/μs	(pulse mode only)
2440, 2440-C	200.000 mV	5 μV	0.02% + 600 μV	1 μV	0.012% + 300 μV		
	2.00000 V	50 μV	0.02% + 600 μV	10 μV	0.012% + 300 μV		±10.5 V @ ±5.25 A
	10.0000 V	500 μV	0.02% + 1.2 mV	100 μV	0.015% + 750 μV	0.08 V/μs	±42 V @ ±1.05 A
	40.0000 V	5 mV	0.02% + 4.8 mV	1 mV	0.015% + 3 mV	0.25 V/μs	

TEMPERATURE COEFFICIENT (0°–18°C & 28°–50°C): ±(0.15 × accuracy specification)/°C.
VOLTAGE REGULATION: Line: 0.01% of range. **Load:** 0.01% of range + 100μV.
OVER VOLTAGE PROTECTION: User selectable values, 5% tolerance. Factory default = none.
CURRENT LIMIT: Bipolar current limit (compliance) set with single value. Min. 0.1% of range.
OVERSHOOT: <0.1% typical (full scale step, resistive load, 10mA range).

ADDITIONAL SOURCE SPECIFICATIONS (All Models)

TRANSIENT RESPONSE TIME: 30μs minimum for the output to recover to its spec. following a step change in load.
COMMAND PROCESSING TIME: Maximum time required for the output to begin to change following the receipt of :SOURCE:VOLTage|CURRent <nrf> command. **Autorange On:** 10ms. **Autorange Off:** 7ms.
OUTPUT SETTLING TIME: Time required to reach 0.1% of final value after command is processed. 100μs typical. Resistive load. 10μA to 100mA range.
DC FLOATING VOLTAGE: Output can be floated up to ±250VDC (Model 2440 ±40VDC) from chassis ground.
REMOTE SENSE: Up to 1V drop per load lead.
COMPLIANCE ACCURACY: Add 0.3% of range and ±0.02% of reading to base specification.
OVER TEMPERATURE PROTECTION: Internally sensed temperature overload puts unit in standby mode.
RANGE CHANGE OVERSHOOT: Overshoot into a fully resistive 100kΩ load, 10Hz to 1MHz BW, adjacent ranges: 100mV typical, except 20V/200V (20V/60V on Model 2420), 20V/100V on Model 2425 and 2430, range boundary, and Model 2440.
MINIMUM COMPLIANCE VALUE: 0.1% of range.

ADDITIONAL PULSE MODE SOURCE SPECIFICATIONS (2430 and 2430-C only)

MAXIMUM DUTY CYCLE: 8%, hardware limited, 10A range only. All other ranges 100%.
MAXIMUM PULSE WIDTH: 5ms from 90% rising to 90% falling edge, 2.5ms 10A range.
MINIMUM PULSE WIDTH: 150μs.
MINIMUM PULSE RESOLUTION: 50μs typical, 70μs max., limited by system jitter.
SOURCE ACCURACY: Determined by settling time and source range specifications.
OUTPUT SETTLING TIME 0.1%:
 800μs typ., source I = 10A into 10Ω, limited by voltage slew rate.
 500μs typ., source I = 10A into 1Ω, limited by voltage slew rate.
OUTPUT SLEW RATE:
Voltage (10Ω load): 0.25V/μs ±30% on 100V range. 0.08V/μs ±30% on 20V range, 10A range.
Current (0Ω load): 0.25A/μs ±30% on 100V range. 0.08A/μs ±30% on 20V range, 10A range.

NOTES

- 2400, 2410 Only: Specifications valid for continuous output currents below 105mA. For operation above 105mA continuous for >1 minute, derate accuracy 10%/35mA above 105mA.
- Speed = Normal (1 PLC). For 0.1 PLC, add 0.005% of range to offset specifications, except 200mV, 1A, 10A ranges, add 0.05%. For 0.01 PLC, add 0.05% of range to offset specifications, except 200mV, 1A, 10A ranges, add 0.5%.
- Accuracies apply to 2- or 4-wire mode when properly zeroed.
- In pulse mode, limited to 0.1 PLC measurement.

Current Accuracy (Local or Remote Sense)

Model	Range	Programming Resolution	Source ^{1,3} Accuracy (1 Year) ³ 23°C ±5°C ±(% rdg. + amps)	Default Measurement Resolution	Measurement ^{5, 6, 7} Accuracy (1 Year) ³ 23°C ±5°C ±(% rdg. + amps)	Source/Sink Limit
2400, 2400-C, 2400-LV	1.00000 µA	50 pA	0.035% + 600 pA	10 pA	0.029% + 300 pA	±1.05A @ ±21 V ±105 mA @ ±210 V ⁸
	10.0000 µA	500 pA	0.033% + 2 nA	100 pA	0.027% + 700 pA	
	100.000 µA	5 nA	0.031% + 20 nA	1 nA	0.025% + 6 nA	
	1.00000 mA	50 nA	0.034% + 200 nA	10 nA	0.027% + 60 nA	
	10.0000 mA	500 nA	0.045% + 2 µA	100 nA	0.035% + 600 nA	
	100.000 mA	5 µA	0.066% + 20 µA	1 µA	0.055% + 6 µA	
	1.00000 A ²	50 µA	0.27 % + 900 µA	10 µA	0.22 % + 570 µA	
2410, 2410-C	1.00000 µA	50 pA	0.035% + 600 pA	10 pA	0.029% + 300 pA	±1.05A @ ±21 V ±21 mA @ ±1100 V
	10.0000 µA	500 pA	0.033% + 2 nA	100 pA	0.027% + 700 pA	
	100.000 µA	5 nA	0.031% + 20 nA	1 nA	0.025% + 6 nA	
	1.00000 mA	50 nA	0.034% + 200 nA	10 nA	0.027% + 60 nA	
	10.0000 mA	500 nA	0.045% + 4 µA	100 nA	0.035% + 1.2 µA	
	100.000 mA	5 µA	0.066% + 20 µA	1 µA	0.055% + 6 µA	
	1.00000 A ²	50 µA	0.27 % + 900 µA	10 µA	0.22 % + 570 µA	
2420, 2420-C	10.0000 µA	500 pA	0.033% + 2 nA	100 pA	0.027% + 700 pA	±3.15A @ ±21 V ±1.05 A @ ±63 V
	100.000 µA	5 nA	0.031% + 20 nA	1 nA	0.025% + 6 nA	
	1.00000 mA	50 nA	0.034% + 200 nA	10 nA	0.027% + 60 nA	
	10.0000 mA	500 nA	0.045% + 2 µA	100 nA	0.035% + 600 nA	
	100.000 mA	5 µA	0.066% + 20 µA	1 µA	0.055% + 6 µA	
	1.00000 A ²	50 µA	0.067% + 900 µA	10 µA	0.066% + 570 µA	
	3.00000 A ²	50 µA	0.059% + 2.7 mA	10 µA	0.052% + 1.71 mA	
2425, 2425-C	10.0000 µA	500 pA	0.033% + 2 nA	100 pA	0.027% + 700 pA	±3.15A @ ±21 V ±1.05 A @ ±105 V
	100.000 µA	5 nA	0.031% + 20 nA	1 nA	0.025% + 6 nA	
	1.00000 mA	50 nA	0.034% + 200 nA	10 nA	0.027% + 60 nA	
	10.0000 mA	500 nA	0.045% + 2 µA	100 nA	0.035% + 600 nA	
	100.000 mA	5 µA	0.066% + 20 µA	1 µA	0.055% + 6 µA	
	1.00000 A ²	50 µA	0.067% + 900 µA	10 µA	0.060% + 570 µA	
	3.00000 A ²	50 µA	0.059% + 2.8 mA	10 µA	0.052% + 1.71 mA	
2430, 2430-C	10.0000 µA	500 pA	0.033% + 2 nA	100 pA	0.027% + 700 pA	±1.05A @ ±105 V ±10.5 A @ ±105 V (pulse mode only)
	100.000 µA	5 nA	0.031% + 20 nA	1 nA	0.025% + 6 nA	
	1.00000 mA	50 nA	0.034% + 200 nA	10 nA	0.027% + 60 nA	
	10.0000 mA	500 nA	0.045% + 2 µA	100 nA	0.035% + 600 nA	
	100.000 mA	5 µA	0.066% + 20 µA	1 µA	0.055% + 6 µA	
	1.00000 A	50 µA	0.067% + 900 µA	10 µA	0.060% + 570 µA	
	3.00000 A ²	500 µA	0.059% + 2.8 mA	10 µA	0.052% + 1.71 mA	
	10.00000 A ⁴	500 µA	0.089% + 5.9 mA	10 µA	0.082% + 1.71 mA	
2440, 2440-C	10.0000 µA	500 pA	0.033% + 2 nA	100 pA	0.027% + 700 pA	±5.25A @ ±10.5 V ±1.05 A @ ±42 V
	100.000 µA	5 nA	0.031% + 20 nA	1 nA	0.025% + 6 nA	
	1.00000 mA	50 nA	0.034% + 200 nA	10 nA	0.027% + 60 nA	
	10.0000 mA	500 nA	0.045% + 2 µA	100 nA	0.035% + 600 nA	
	100.000 mA	5 µA	0.066% + 20 µA	1 µA	0.055% + 6 µA	
	1.00000 A	50 µA	0.067% + 900 µA	10 µA	0.060% + 570 µA	
	5.00000 A	50 µA	0.10 % + 5.4 mA	10 µA	0.10 % + 3.42 mA	

TEMPERATURE COEFFICIENT (0°–18°C & 28°–50°C): ±(0.15 × accuracy specification)/°C.

CURRENT REGULATION: Line: 0.01% of range. Load: 0.01% of range (except Model 2440 5A range 0.05%) + 100pA.

VOLTAGE LIMIT: Bipolar voltage limit (compliance) set with single value. Min. 0.1% of range.

OVERSHOOT: <0.1% typical (1mA step, RL = 10kΩ, 20V range for Model 2400, 2410, 2420, 2425, 2430), (10V range for Model 2440).

CONTACT CHECK SPECIFICATIONS (requires -C version)

SPEED: 350µs for verification and notification.

CONTACT CHECK: 2 Ω 15 Ω 50 Ω

No contact check failure <1.00 Ω <13.5 Ω <47.5 Ω

Always contact check failure >3.00 Ω >16.5 Ω >52.5 Ω

NOTES

- 2400, 2410 Only: Specifications valid for continuous output currents below 105mA. For operation above 105mA continuous for >1 minute, derate accuracy 10%/35mA above 105mA.
- Full operation (1A) regardless of load to 30°C (50°C for Model 2420 and 2440). Above 30°C (50°C for Model 2420 and 2440) ambient, derate 35mA/°C and prorata 35mA/Ω load. 4-wire mode. For current sink operation on 1A, 3A, or 5A ranges, maximum continuous power is limited to approximately 1/2 rated power or less, depending on current, up to 30°C ambient. See power equations in the User's Manual to calculate allowable duty cycle for specific conditions.
- For sink mode, 1µA to 100mA range, accuracy is:
Model 2400: ±(0.15% + offset*4). Models 2410, 2420, 2425, 2430, 2440: ±(0.5% + offset*3).
For 1A range, accuracy is:
Model 2400: ±(1.5% + offset*8). Models 2410, 2420, 2425, 2430, 2440: ±(1.5% + offset*3).
- 10A range only in pulse mode. Limited to 2.5ms pulse width maximum. 10% duty cycle maximum.
- Speed = Normal (1 PLC). For 0.1 PLC, add 0.005% of range to offset specifications, except 200mV, 1A, 10A ranges, add 0.05%. For 0.01 PLC, add 0.05% of range to offset specifications, except 200mV, 1A, 10A ranges, add 0.5%.
- Accuracies apply to 2- or 4-wire mode when properly zeroed.
- In pulse mode, limited to 0.1 PLC measurement.
- Model 2400 and 2400-C only.

1.888.KEITHLEY (U.S. only)

www.keithley.com

KEITHLEY

Resistance Measurement Accuracy (Local or Remote Sense)^{1, 2, 5}

Range	Default Resolution	Default Test Current 2400, 2410	Default Test Current 2420, 2425, 2430, 2440	Normal Accuracy (23°C ±5°C) 1 Year, ±(% rdg. + ohms)			Enhanced Accuracy (23°C ±5°C) ⁴ 1 Year, ±(% rdg. + ohms)
				2400	2410	2420, 2425, 2430, 2440	2400
<0.20000Ω ³	–	–	–	Source I _{ACC} + Meas. V _{ACC}	Source I _{ACC} + Meas. V _{ACC}	Source I _{ACC} + Meas. V _{ACC}	Source I _{ACC} + Meas. V _{ACC}
2.00000Ω ³	10 μΩ	–	1 A	Source I _{ACC} + Meas. V _{ACC}	Source I _{ACC} + Meas. V _{ACC}	0.17% + 0.0003Ω	Source I _{ACC} + Meas. V _{ACC}
20.0000 Ω	100 μΩ	100 mA	100 mA	0.10% + 0.003 Ω	0.11% + 0.006 Ω	0.10% + 0.003 Ω	0.07% + 0.001 Ω
200.000 Ω	1 mΩ	10 mA	10 mA	0.08% + 0.03 Ω	0.09% + 0.1 Ω	0.08% + 0.03 Ω	0.05% + 0.01 Ω
2.00000kΩ	10 mΩ	1 mA	1 mA	0.07% + 0.3 Ω	0.08% + 0.6 Ω	0.07% + 0.3 Ω	0.05% + 0.1 Ω
20.0000kΩ	100 mΩ	100 μA	100 μA	0.06% + 3 Ω	0.07% + 6 Ω	0.06% + 3 Ω	0.04% + 1 Ω
200.000kΩ	1 Ω	10 μA	10 μA	0.07% + 30 Ω	0.07% + 60 Ω	0.07% + 30 Ω	0.05% + 10 Ω
2.00000MΩ ⁶	10 Ω	1 μA	1 μA	0.11% + 300 Ω	0.12% + 600 Ω	0.11% + 300 Ω	0.05% + 100 Ω
20.0000MΩ ⁷	100 Ω	1 μA	1 μA	0.11% + 1 kΩ	0.12% + 2.4 kΩ	0.11% + 1 kΩ	0.05% + 500 Ω
200.000MΩ ³	1 kΩ	100 nA	–	0.66% + 10 kΩ	0.66% + 24 kΩ	Source I _{ACC} + Meas. V _{ACC}	0.35% + 5 kΩ
>200.000MΩ ³	–	–	–	Source I _{ACC} + Meas. V _{ACC}	Source I _{ACC} + Meas. V _{ACC}	Source I _{ACC} + Meas. V _{ACC}	Source I _{ACC} + Meas. V _{ACC}

TEMPERATURE COEFFICIENT (0°–18°C & 28°–50°C): ±(0.15 × accuracy specification)/°C.

SOURCE I MODE, MANUAL OHMS: Total uncertainty = I source accuracy + V measure accuracy (4-wire remote sense).

SOURCE V MODE, MANUAL OHMS: Total uncertainty = V source accuracy + I measure accuracy (4-wire remote sense).

6-WIRE OHMS MODE: Available using active ohms guard and guard sense. Max. Guard Output Current: 50mA (except 1A range). Accuracy is load dependent. Refer to White Paper no. 2033 for calculation formula.

GUARD OUTPUT IMPEDANCE: <0.1Ω in ohms mode.

NOTES:

- Speed = Normal (1 PLC). For 0.1 PLC, add 0.005% of range to offset specifications, except 200mV, 1A, 10A ranges, add 0.05%. For 0.01 PLC, add 0.05% of range to offset specifications, except 200mV, 1A, 10A ranges, add 0.5%.
- Accuracies apply to 2- or 4-wire mode when properly zeroed.
- Manual ohms only – except 2420, 2425, 2430, 2440 for 2Ω range and 2410 or 2400 for 200MΩ range.
- Source readback enabled, offset compensation ON. Also available on 2410, 2420, 2425, 2430, and 2440 with similar accuracy enhancement.
- In pulse mode, limited to 0.1 PLC measurement.
- Except 2440; default test current is 5μA.
- Except 2440; default test current is 0.5μA.

SERVICES AVAILABLE

2400-3Y-EW	1-year factory warranty extended to 3 years from date of shipment
2400-C-3Y-EW	1-year factory warranty extended to 3 years from date of shipment
2400-1V-3Y-EW	1-year factory warranty extended to 3 years from date of shipment
2410-3Y-EW	1-year factory warranty extended to 3 years from date of shipment
2410-C-3Y-EW	1-year factory warranty extended to 3 years from date of shipment
2420-3Y-EW	1-year factory warranty extended to 3 years from date of shipment
2420-C-3Y-EW	1-year factory warranty extended to 3 years from date of shipment
2425-3Y-EW	1-year factory warranty extended to 3 years from date of shipment
2425-C-3Y-EW	1-year factory warranty extended to 3 years from date of shipment
2430-3Y-EW	1-year factory warranty extended to 3 years from date of shipment
2430-C-3Y-EW	1-year factory warranty extended to 3 years from date of shipment
2440-3Y-EW	1-year factory warranty extended to 3 years from date of shipment
2440-C-3Y-EW	1-year factory warranty extended to 3 years from date of shipment
C/2400-3Y-ISO	3 (ISO-17025 accredited) calibrations within 3 years of purchase for Models 2400, 2400-C, 2400-1V*
C/2410-3Y-ISO	3 (ISO-17025 accredited) calibrations within 3 years of purchase for Models 2410, 2410-C*
C/2420-3Y-ISO	3 (ISO-17025 accredited) calibrations within 3 years of purchase for Models 2420, 2420-C*
C/2425-3Y-ISO	3 (ISO-17025 accredited) calibrations within 3 years of purchase for Models 2425, 2425-C*
C/2430-3Y-ISO	3 (ISO-17025 accredited) calibrations within 3 years of purchase for Models 2430, 2430-C*
C/2440-3Y-ISO	3 (ISO-17025 accredited) calibrations within 3 years of purchase for Models 2440, 2440-C*
TRN-2400-1-C	Course: Unleashing the Power of Your SourceMeter Instrument

*Not available in all countries

1.888.KEITHLEY (U.S. only)

www.keithley.com

KEITHLEY



System Speeds

MEASUREMENT¹

MAXIMUM RANGE CHANGE RATE: 75/second.

MAXIMUM MEASURE AUTORANGE TIME: 40ms (fixed source).²

Sweep Operation³ Reading Rates (rdg./second) for 60Hz (50Hz):

Speed	NPLC/Trigger Origin	Measure		Source-Measure		Source-Measure ⁵ Pass/Fail Test ^{4, 5}		Source-Memory ⁴	
		To Mem.	To GPIB	To Mem.	To GPIB	To Mem.	To GPIB	To Mem.	To GPIB
Fast	0.01 / internal	2081 (2030)	1754	1551 (1515)	1369	902 (900)	981	165 (162)	165
IEEE-488.1 Mode	0.01 / external	1239 (1200)	1254	1018 (990)	1035	830 (830)	886	163 (160)	163
Fast	0.01 / internal	2081 (2030)	1198 (1210)	1551 (1515)	1000 (900)	902 (900)	809 (840)	165 (162)	164 (162)
IEEE-488.2 Mode	0.01 / external	1239 (1200)	1079 (1050)	1018 (990)	916 (835)	830 (830)	756 (780)	163 (160)	162 (160)
Medium	0.10 / internal	510 (433)	509 (433)	470 (405)	470 (410)	389 (343)	388 (343)	133 (126)	132 (126)
IEEE-488.2 Mode	0.10 / external	438 (380)	438 (380)	409 (360)	409 (365)	374 (333)	374 (333)	131 (125)	131 (125)
Normal	1.00 / internal	59 (49)	59 (49)	58 (48)	58 (48)	56 (47)	56 (47)	44 (38)	44 (38)
IEEE-488.2 Mode	1.00 / external	57 (48)	57 (48)	57 (48)	57 (47)	56 (47)	56 (47)	44 (38)	44 (38)

Single Reading Operation Reading Rates (rdg./second) for 60Hz (50Hz):

Speed	NPLC/Trigger Origin	Measure To GPIB	Source-Measure ⁵ To GPIB	Source-Measure Pass/Fail Test ^{4, 5} To GPIB
Fast (488.1)	0.01 / internal	537	140	135
Fast (488.2)	0.01 / internal	256 (256)	79 (83)	79 (83)
Medium (488.2)	0.10 / internal	167 (166)	72 (70)	69 (70)
Normal (488.2)	1.00 / internal	49 (42)	34 (31)	35 (30)

Component for 60Hz (50Hz):^{4, 6}

Speed	NPLC/Trigger Origin	Measure To GPIB	Source Pass/Fail Test	Source-Measure Pass/Fail Test ^{5, 7} To GPIB
Fast	0.01 / external	1.04 ms (1.08 ms)	0.5 ms (0.5 ms)	4.82 ms (5.3 ms)
Medium	0.10 / external	2.55 ms (2.9 ms)	0.5 ms (0.5 ms)	6.27 ms (7.1 ms)
Normal	1.00 / external	17.53 ms (20.9 ms)	0.5 ms (0.5 ms)	21.31 ms (25.0 ms)

¹ Reading rates applicable for voltage or current measurements. Auto zero off, autorange off, filter off, display off, trigger delay = 0, and binary reading format.

² Purely resistive load. 1µA and 10µA ranges <65ms.

³ 1000 point sweep was characterized with the source on a fixed range.

⁴ Pass/Fail test performed using one high limit and one low math limit.

⁵ Includes time to re-program source to a new level before making measurement.

⁶ Time from falling edge of START OF TEST signal to falling edge of END OF TEST signal.

⁷ Command processing time of :SOUR:VOLTage|CURRent:TRIGgered <nrf> command not included.

GENERAL

Noise Rejection:

	NPLC	NMRR	CMRR
Fast	0.01	—	80 dB
Medium	0.1	—	80 dB
Slow	1	60 dB	100 dB ¹

¹ Except lowest 2 current ranges = 90dB.

LOAD IMPEDANCE: Stable into 20,000pF typical.

COMMON MODE VOLTAGE: 250V DC (40V DC for Model 2440).

COMMON MODE ISOLATION: >10⁹Ω, <1000pF.

OVERRANGE: 105% of range, source and measure.

MAX. VOLTAGE DROP BETWEEN INPUT/OUTPUT AND SENSE TERMINALS: 5V.

MAX. SENSE LEAD RESISTANCE: 1MΩ for rated accuracy.

SENSE INPUT IMPEDANCE: >10¹⁰Ω.

GUARD OFFSET VOLTAGE: <150µV, typical (300µV for Models 2430, 2440).

SOURCE OUTPUT MODES:

- Pulse (Model 2430 only)
- Fixed DC level
- Memory List (mixed function)
- Stair (linear and log)

MEMORY BUFFER: 5,000 readings @ 5 digits (two 2,500 point buffers). Includes selected measured value(s) and time stamp. Lithium battery backup (3 yr+ battery life).

SOURCE MEMORY LIST: 100 points max.

PROGRAMMABILITY: IEEE-488 (SCPI-1995.0), RS-232, 5 user-definable power-up states plus factory default and *RST.

DIGITAL INTERFACE:

Interlock: Active low input.

Handler Interface: Start of test, end of test, 3 category bits. +5V@ 300mA supply.

Digital I/O: 1 trigger input, 4 TTL/Relay Drive outputs (33V @ 500mA, diode clamped).

POWER SUPPLY: 100V to 240V rms, 50–60Hz (automatically detected at power up). Model 2400: 190VA. Model 2410: 210VA. Model 2420: 220VA. Model 2425, 2430: 250VA. Model 2440: 240VA.

COOLING: (Model 2410, 2420, 2425, 2430, 2440): Forced air, variable speed.

EMC: Conforms to European Union Directive 89/336/EEC, EN 61326-1.

SAFETY: Conforms to European Union Directive 73/23/EEC, EN61010-1.

VIBRATION: MIL-PRF-28800F Class 3 Random.

WARM-UP: 1 hour to rated accuracies.

DIMENSIONS: 89mm high × 213mm wide × 370mm deep (3½ in × 8½ in × 14½ in). Bench Configuration (with handle & feet): 104mm high × 238mm wide × 370mm deep (4½ in × 9½ in × 14½ in).

WEIGHT: 3.21kg (7.08 lbs) (Model 2425, 2430, 2440: 4.1kg, 9.0 lbs).

ENVIRONMENT: Operating: 0°–50°C, 70%R.H. up to 35°C. Derate 3% R.H./°C, 35°–50°C.

Storage: –25°C to 65°C.