

AEL-5000 Series AC & DC Electronic Load

The AEL-5000 series's AC rectifier load simulation complies with IEC62040-3 and IEC61683 test specifications.

IEC62040-3: Uninterruptible power systems (UPS) - Part 3: Method of specifying the performance and test requirements

IEC61683: Photovoltaic Systems - Power Conditioners - Procedure for Measuring Efficiency

AEL-5000 complies with IEC62040-3 and IEC61683 test specifications.

The AC rectifier mode of the AEL-5000 supports non-linear load (Non-Linear CC) mode during rectification and non-linear load (Non-Linear CC) + resistance load (CR) mode.

Ideal for evaluating UPS to PV inverters (PCS).

The 3.75kW model is a 4U size, 33.5kg ultra-compact AC / DC electronic load.



CC, Linear CC, CR, CV, CP and AC Rectifier Load Mode

Frequency Range : DC, 40~440Hz

Turbo Mode for 2 Times the Current and Power of Electronic Load within 1 second

Three Units Parallel up to 90kW and Three-phase Δ or Y Load Connection Can be Synchronized Control by One Master Unit

Loading and Unloading Angle Control; 0~359 Degree is Settable

Positive Half-cycle or Negative Half-cycle Loading

Supports SCR/TRIAC Current Phase Modulation Waveforms, 90 Degree Trailing Edge and Leading Edge

Optional Interface : GPIB、RS232、USB、LAN

MODEL	Power (W)	Current(A)	Voltage(Volt)
AEL-5002-350-18.75	1875 W	18.75 Arms / 56.25Apeak	50~350Vrms / 500Vdc
AEL-5003-350-28	2800W	28 Arms / 84Apeak	
AEL-5004-350-37.5	3750 W	37.5 Arms / 112.5Apeak	
AEL-5002-425-18.75	1875 W	18.75 Arms / 56.25Apeak	50~425Vrms / 600Vdc
AEL-5003-425-28	2800W	28 Arms / 84Apeak	
AEL-5004-425-37.5	3750 W	37.5 Arms / 112.5Apeak	
AEL-5006-350-56	5600 W	56.0 Arms / 168Apeak	50~350Vrms / 500Vdc
AEL-5008-350-75	7500 W	75.0 Arms / 225Apeak	
AEL-5012-350-112.5	11250W	112.5 Arms / 337.5Apeak	
AEL-5015-350-112.5	15000W	112.5 Arms / 337.5Apeak	
AEL-5019-350-112.5	18750W	112.5 Arms / 337.5Apeak	
AEL-5023-350-112.5	22500W	112.5 Arms / 337.5Apeak	
AEL-5006-425-56	5600 W	56.0 Arms / 168Apeak	50~425Vrms / 600Vdc
AEL-5008-425-75	7500 W	75.0 Arms / 225Apeak	
AEL-5012-425-112.5	11250W	112.5 Arms / 337.5Apeak	
AEL-5015-425-112.5	15000W	112.5 Arms / 337.5Apeak	
AEL-5019-425-112.5	18750W	112.5 Arms / 337.5Apeak	
AEL-5023-425-112.5	22500W	112.5 Arms / 337.5Apeak	
AEL-5003-480-18.75	2800W	18.75 Arms / 56.25Apeak	50~480Vrms / 700Vdc
AEL-5004-480-28	3750 W	28 Arms / 84Apeak	

AC rectified load simulation meet the IEC62040-3 and IEC61683 test specifications

The AEL-5000 series Rectifier Load Mode supports IEC 62040-3 and IEC 61683 test specifications.

Rectifier Load Mode supports non-linear load (Non-Linear CC) mode and non-linear load (Non-Linear CC) + resistance load (CR) mode during rectification. The AEL-5000 series is suitable for evaluating UPS to PV power converters (PCS).

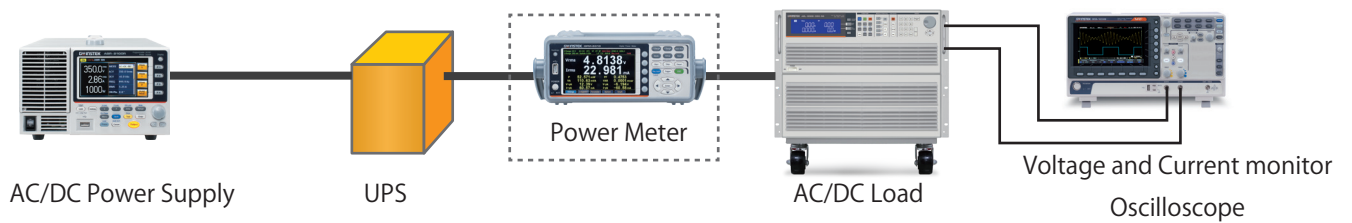
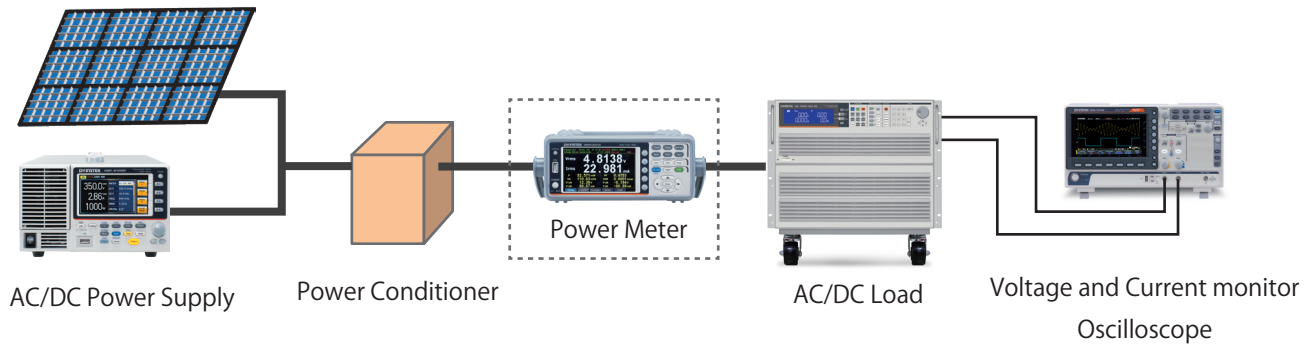

Voltage and current waveforms can be observed!

The AEL-5000 is equipped with a voltage / current monitor terminal on the Rear panel. Since the voltage / current monitor terminal is isolated, it can be safely observed with an oscilloscope.

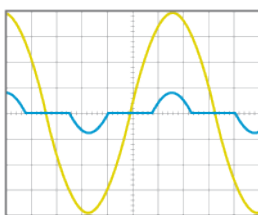
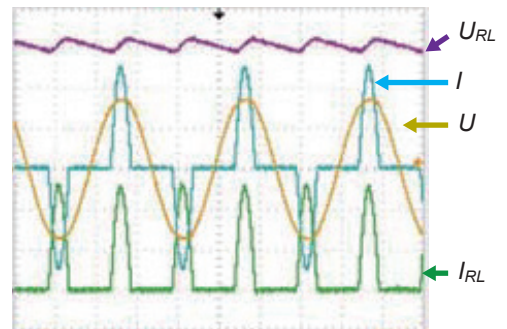
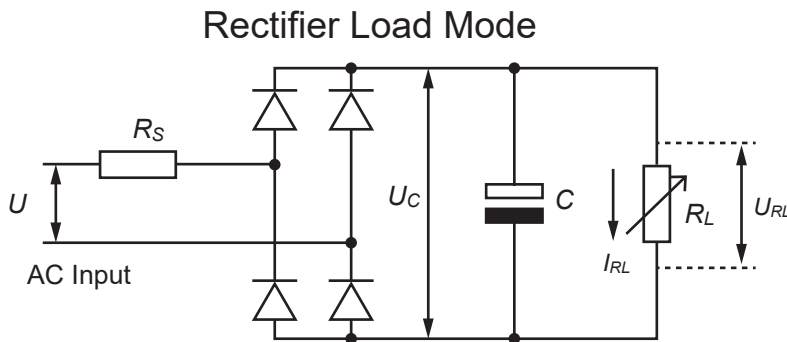
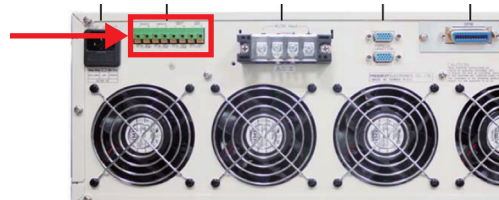

Non-Linear CC mode for UPS test

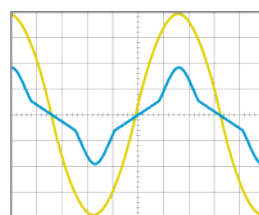
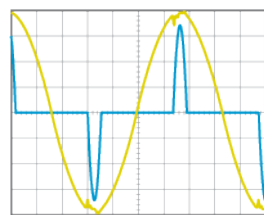

110V, 5A + 22 ohms
Test Waveform

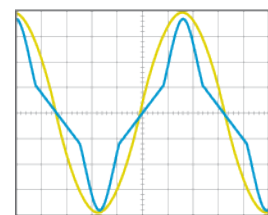

110V, 10A + 11 ohms
Test Waveform

Current / voltage waveform during PV power converter test