

User's Guide

EL30000 Series DC Electronic Loads



Notices	6
Copyright Notice	6
Manual Part Number	6
Edition	6
Published by	6
Warranty	6
Technology Licenses	6
U.S. Government Rights	7
Third Party Licenses	7
Waste Electrical and Electronic Equipment (WEEE)	7
Declarations of Conformity	7
Safety Information	8
Safety and Regulatory Information	9
Safety Considerations	9
Safety Symbols	12
Regulatory Markings	13
South Korean Class A EMC declaration:	13
Safety and EMC Requirements	13
Environmental Conditions	14
1 Getting Started	15
Product Introduction	16
Front panel at a glance (EL33133A/EL34143A)	18
Front panel at a glance (EL34243A)	19
Rear panel at a glance (EL33133A/EL34143A)	20
Rear panel at a glance (EL34243A)	21
Meter view	22
Data logger view	24
Scope view	25
Dimension diagram	26
Setup the instrument	26
Prepare Instrument for Use	27
Initial inspection	27
Standard shipped items	27
Documentation and firmware revisions	27
Recommended calibration interval	27
Load Operating Modes	28
CC mode	28
CV mode	29
CP mode	29
CR mode	30
Programming Ranges	31
Installation	33
Connecting the power cord	33
Connecting the inputs	34
Parallel connections (EL34243A only)	37
4-wire sense connection	39
Interface connections	41
Installing the optional GPIB interface (EL34143A and EL34243A only)	45
Rack mounting the instrument	46
Remote Interface Configuration	47

Keysight IO Libraries Suite	47
GPIB configuration	47
LAN configuration	48
Using sockets	52
More about IP addresses and dot notation	53
Remote Control	54
Web interface	54
Technical connection details	56
Use the Built-in Help System	57
View the help information for the front panel key	57
View the list of help topics	57
Firmware Update	59
Front Panel Menu Reference	60
2 General Operating Information	61
Turning the Unit On	62
Using the front panel knobs	63
View the error log	63
Controlling the Inputs	64
Step 1 - Select an input (EL34243A only)	64
Step 2 - Set the load operating mode	64
Step 3 - Set the input voltage, current, resistance, or power	64
Step 4 - Enable the input	65
Step 5 - View the input voltage and current	65
Using the Protection Function	67
Protection function	67
Configuring protection	67
Clears OVP, OCP and OPP Event	69
Specifying 2-Wire or 4-Wire Sense	70
Configuring the Input Turn-On/Turn-Off Sequence	71
Step 1 - Set the input voltage, current, power or resistance of the input channels:	71
Step 2 - Configure the turn-on turn-off delays:	71
Step 3 - Coupling selected inputs:	71
Step 4 - Use the All Inputs On and Off keys:	71
Specifying the Load Operating Mode	73
Configuring the Load Settings	74
Operating modes	74
Specifying the Operation Mode (EL34243A only)	78
Using the Digital Control Port	79
Bi-directional digital IO	79
Digital input	81
Fault output	81
Inhibit input	82
Fault/inhibit system protection	83
Trigger input	84
Trigger output	85
Input couple controls	86
Using the Sequencer Function (EL34143A and EL34243A only)	88
LIST mode	88
Step 1 - Add/remove steps to/from the LIST	88
Step 2 - Configure the input sequence	89
Step 3 - Run the input sequence list	91

Continuous mode	93
Step 1 – Configure the sequence properties	93
Step 2 – Run the input sequence	94
Pulse mode	96
Step 1 – Configure the sequence properties	96
Step 2 – Run the input sequence	97
Toggle mode	99
Step 1 – Configure the sequence properties	99
Step 2 – Run the input sequence	100
Using the Data Logger Function	101
Logging data	101
Step 1 – Set the load operating mode to CC	101
Step 2 – Program the input current values	101
Step 3 – Program the sequence for the input channels	101
Step 4 – Configure the data logger traces	102
Step 5 – Configure the data logger properties	102
Step 6 – Configure and enable the DUT output accordingly	103
Step 7 – Turn on Input 1, start the sequencing and log the data	103
Step 8 – Export the data	103
Data logger view	105
Data logger marker view	106
Using the knob in data logger view	107
Data logger properties and waveform settings	108
Save the data log	112
Using the Scope Function	115
Making measurement	115
Step 1 – Set the load operating mode to CC	115
Step 2 – Program the input current values	115
Step 3 – Configure the input turn-on sequence	115
Step 4 – Configure the Scope View traces	116
Step 5 – Configure the Scope properties:	116
Step 6 – Configure and enable the DUT output accordingly	117
Step 7 – Turn on the inputs and measure the current:	117
From the remote interface:	117
Scope View	118
Scope marker view	120
Using the knob in scope view	121
Scope properties and waveform settings	122
Scope marker properties	125
Save the scope data	125
Locking/Unlocking the Front Panel	126
Capturing a Screen	126
Utilities Menu	127
Utilities Menu – Store and Recall State	127
Store Settings	128
Recall Settings	129
Power On Setting	130
Set to Defaults	130
Utilities Menu – I/O Configuration	131
LAN Settings	131
Digital IO	132
GPIB (optional)	132

Utilities Menu - Test / Setup	133
Calibration	133
Self-Test	133
User Settings	134
Low Range	135
Help	135
Utilities Menu - Error	137
Utilities Menu - Manage Files	138
Action	138
Browse	139
File Name	139
3 Characteristics and Specifications	140

Notices

Copyright Notice

© Keysight Technologies 2020

No part of this manual may be reproduced in any form or by any means (including electronic storage and retrieval or translation into a foreign language) without prior agreement and written consent from Keysight Technologies as governed by United States and international copyright laws.

Manual Part Number

EL34243-90000

Edition

Edition 1, November 15, 2020

Published by

Keysight Technologies
Bayan Lepas Free Industrial Zone
11900 Bayan Lepas, Penang
Malaysia

Warranty

THE MATERIAL CONTAINED IN THIS DOCUMENT IS PROVIDED "AS IS," AND IS SUBJECT TO BEING CHANGED, WITHOUT NOTICE, IN FUTURE EDITIONS. FURTHER, TO THE MAXIMUM EXTENT PERMITTED BY APPLICABLE LAW, KEYSIGHT DISCLAIMS ALL WARRANTIES, EITHER EXPRESS OR IMPLIED, WITH REGARD TO THIS MANUAL AND ANY INFORMATION CONTAINED HEREIN, INCLUDING BUT NOT LIMITED TO THE IMPLIED WARRANTIES OF MERCHANTABILITY AND FITNESS FOR A PARTICULAR PURPOSE. KEYSIGHT SHALL NOT BE LIABLE FOR ERRORS OR FOR INCIDENTAL OR CONSEQUENTIAL DAMAGES IN CONNECTION WITH THE FURNISHING, USE, OR PERFORMANCE OF THIS DOCUMENT OR OF ANY INFORMATION CONTAINED HEREIN. SHOULD KEYSIGHT AND THE USER HAVE A SEPARATE WRITTEN AGREEMENT WITH WARRANTY TERMS COVERING THE MATERIAL IN THIS DOCUMENT THAT CONFLICT WITH THESE TERMS, THE WARRANTY TERMS IN THE SEPARATE AGREEMENT SHALL CONTROL.

Technology Licenses

The hardware and/or software described in this document are furnished under a license and may be used or copied only in accordance with the terms of such license.

U.S. Government Rights

The Software is “commercial computer software,” as defined by Federal Acquisition Regulation (“FAR”) 2.101. Pursuant to FAR 12.212 and 27.405-3 and Department of Defense FAR Supplement (“DFARS”) 227.7202, the U.S. government acquires commercial computer software under the same terms by which the software is customarily provided to the public. Accordingly, Keysight provides the Software to U.S. government customers under its standard commercial license, which is embodied in its End User License Agreement (EULA), a copy of which can be found at <http://www.keysight.com/find/sweula>. The license set forth in the EULA represents the exclusive authority by which the U.S. government may use, modify, distribute, or disclose the Software. The EULA and the license set forth therein, does not require or permit, among other things, that Keysight: (1) Furnish technical information related to commercial computer software or commercial computer software documentation that is not customarily provided to the public; or (2) Relinquish to, or otherwise provide, the government rights in excess of these rights customarily provided to the public to use, modify, reproduce, release, perform, display, or disclose commercial computer software or commercial computer software documentation. No additional government requirements beyond those set forth in the EULA shall apply, except to the extent that those terms, rights, or licenses are explicitly required from all providers of commercial computer software pursuant to the FAR and the DFARS and are set forth specifically in writing elsewhere in the EULA. Keysight shall be under no obligation to update, revise or otherwise modify the Software. With respect to any technical data as defined by FAR 2.101, pursuant to FAR 12.211 and 27.404.2 and DFARS 227.7102, the U.S. government acquires no greater than Limited Rights as defined in FAR 27.401 or DFAR 227.7103-5 (c), as applicable in any technical data.

Third Party Licenses

Portions of this software are licensed by third parties including open source terms and conditions. For more information, please contact Keysight support, <http://www.keysight.com/find/assist>.

Waste Electrical and Electronic Equipment (WEEE)

This product complies with the WEEE Directive marking requirement. The affixed product label (see below) indicates that you must not discard this electrical/electronic product in domestic household waste.

Product category: With reference to the equipment types in the WEEE directive Annex 1, this product is classified as “Monitoring and Control instrumentation” product. Do not dispose in domestic household waste.

To return unwanted products, contact your local Keysight office, or see

about.keysight.com/en/companyinfo/environment/takeback.shtml for more information.



Declarations of Conformity

Declarations of Conformity for this product and for other Keysight products may be downloaded from the Web. Go to <https://regulations.about.keysight.com/DoC/default.htm>. You can then search by product number to find the latest Declaration of Conformity.

Safety Information

CAUTION

A CAUTION notice denotes a hazard. It calls attention to an operating procedure, practice, or the like that, if not correctly performed or adhered to, could result in damage to the product or loss of important data. Do not proceed beyond a CAUTION notice until the indicated conditions are fully understood and met.

WARNING

A WARNING notice denotes a hazard. It calls attention to an operating procedure, practice, or the like that, if not correctly performed or adhered to, could result in personal injury or death. Do not proceed beyond a WARNING notice until the indicated conditions are fully understood and met.

Safety and Regulatory Information

Safety Considerations

The following general safety precautions must be observed during all phases of operation, service, and repair of this instrument. Failure to comply with these precautions or with specific warnings elsewhere in this manual violates safety standards of design, manufacture, and intended use of the instrument. Keysight Technologies assumes no liability for the customer's failure to comply with these requirements.

WARNING BEFORE APPLYING POWER

- Verify that the product is set to match the available line voltage and all safety precautions are taken. Note the instrument's external markings are described under **Safety Symbols**.
- Ensure the mains supply voltage fluctuation do not exceed $\pm 10\%$ of the nominal supply voltage.

GROUND THE INSTRUMENT

This product is a Safety Class I instrument (provided with a protective earth terminal). To minimize shock hazard, the instrument chassis and cover must be connected to an electrical ground. The instrument must be connected to the AC mains through a three-conductor power cable, with the third wire firmly connected to an electrical ground (safety ground) at the power outlet. Any interruption of the protective (grounding) conductor or disconnection of the protective earth terminal will cause a potential shock hazard that could result in personal injury.

DO NOT OPERATE IN AN EXPLOSIVE ATMOSPHERE OR WET ENVIRONMENTS

Do not operate the device around flammable gases or fumes, vapor, or wet environments.

DO NOT OPERATE DAMAGED OR DEFECTIVE INSTRUMENTS

Instruments that appear damaged or defective should be made inoperative and secured against unintended operation until they can be repaired by qualified service personnel.

DO NOT SUBSTITUTE PARTS OR MODIFY INSTRUMENT

Because of the danger of introducing additional hazards, do not install substitute parts or perform any unauthorized modification to the instrument. Return the instrument to a Keysight Technologies Sales and Service Office for service and repair to ensure that safety features are maintained. To contact Keysight for sales and technical support, refer to the support links on the following Keysight website: www.keysight.com/find/assist (worldwide contact information for repair and service).

USE THE POWER CORD PROVIDED

Use the device with the power cord provided with the shipment.

USE THE DEVICE AS SPECIFIED

If the device is used in a manner not specified by manufacturer, the device protection may be impaired.

DO NOT BLOCK VENTILATION HOLES

Do not block the rear ventilation hole and keep at least 130 mm free space from the rear panel.

OBSERVE ALL DEVICE MARKINGS BEFORE CONNECTING TO DEVICE

Observe all markings on the device before connecting any wiring to the device.

TURN DEVICE OFF BEFORE CONNECTING TO INPUT TERMINALS

Turn off the device power before connecting to the input terminals.

WARNING ENSURE THE REAR MATING CONNECTOR IS FIRMLY SCREWED

Ensure the rear mating connector is firmly screwed to the rear input terminal. This connector comes together with the instrument and is connected to the rear input terminal.

DO NOT REMOVE REAR MATING CONNECTOR

- Do not remove the rear mating connector as it acts as safety cover to the rear input terminal.
 - Rear input terminal connection must be performed with the presence of mating connector.
-

ENSURE COVER IS SECURED IN PLACE

Do not operate the device with the cover removed or loosened.

TURN DEVICE OFF AND REMOVE ALL CONNECTIONS BEFORE INSTALLING THE GPIB INTERFACE

Turn off the power and remove all connections, including the power cord, from the instrument prior installation of the GPIB interface.

ENSURE PROPER AWG CABLE IS USED

Use a cable with the correct voltage and AWG rating based on the intended setup when operating the EL30000 Series DC electronic loads.

DO NOT TOUCH CABLES DURING OPERATION

Do not touch the cable while the instrument input is operational to prevent electric shock hazard and burn hazard.

DO NOT CONNECT FRONT AND REAR INPUT TERMINAL CONCURRENTLY

Do not connect the front and rear input terminal concurrently for the same input channel. Failing to observe the connection requirement could potentially raise a fire hazard if the input current exceeding 60 A.

LETHAL VOLTAGES AND CURRENTS

- Keep away from live circuits. This instrument operates up to 150 V_{DC} and 60 A_{DC} at its input terminals and sense terminal.
 - SHOCK HAZARD. Floating voltage must not exceed 240 V_{DC}. The total voltage on the input terminal and the floating voltage must not be more than 240 V_{DC} from chassis ground.
 - The input terminal is designed for DC application. Ensure that transient voltages do not exceed 480 V_{PK} or 480 V_{DC}.
 - The connector screw terminals will be at hazardous potential when in operation.
 - Personal injury on contact may result if these terminals are touched when equipment is in operation.
 - To avoid injuries, always disconnect power, discharge circuits, and remove external voltage sources before any installation.
 - Installation procedures must be performed by a qualified and trained personnel on this equipment.
-

DO NOT REMOVE THE INSTRUMENT COVER

Operating personnel must not remove instrument covers. Component replacement and internal adjustments must be made only by qualified service personnel.

CLEANING

To prevent electric shock, unplug the unit before cleaning.









COIN BATTERY REPLACEMENT

- Be sure to use battery (KPN 1420-0942) for the coin battery replacement.
 - Incorrect battery type and battery polarity used during the battery replacement can cause damage to the instrument.
 - Refer to *EL30000 Service Guide* for coin battery replacement procedures. Battery replacement must be made only by qualified service personnel.
-

CAUTION**CLEAN WITH DRY CLOTH**

Clean the outside of the instrument with a soft, lint-free, dry cloth. Do not use detergent, volatile liquids, or chemical solvents.

Safety Symbols

Symbol	Description
	Caution, risk of danger (refer to the manual for specific Warning or Caution information)
	Caution, risk of electric shock
	Protective earth (ground) terminal.
	Earth ground
	Frame or chassis (ground) terminal.
	Standby supply. The instrument is not completely disconnected from AC mains when switch is off.
	Alternating current (AC).
	Plus, positive polarity.
	Minus, negative polarity.
WARNING	A WARNING sign denotes a hazard. It calls attention to a procedure, practice, or the like, which, if not correctly performed or adhered to, could result in personal injury or death. Do not proceed beyond a WARNING sign until the indicated conditions are fully understood and met.
CAUTION	A CAUTION sign denotes a hazard. It calls attention to an operating procedure, or the like, which, if not correctly performed or adhered to, could result in damage to or destruction of part or all of the product. Do not proceed beyond CAUTION sign until the indicated conditions are fully understood and met.
NOTE	A NOTE sign denotes important information. It calls attention to a procedure, practice, condition or the like, which is essential to highlight.

Regulatory Markings

Symbol	Description
	The RCM mark is a registered trademark of the Australian Communications and Media Authority.
	The CE mark is a registered trademark of the European Community. This CE mark shows that the product complies with all the relevant European Legal Directives. ICES/NMB-001 indicates that this ISM device complies with the Canadian ICES-001. Cet appareil ISM est conforme a la norme NMB-001 du Canada. ISM GRP.1 Class A indicates that this is an Industrial Scientific and Medical Group 1 Class A product.
	This symbol indicates the time period during which no hazardous or toxic substance elements are expected to leak or deteriorate during normal use. Forty years is the expected useful life of the product.
	This symbol is a South Korean Class A EMC Declaration. This is a Class A instrument suitable for professional use and in electromagnetic environment outside of the home.
	The CSA mark is a registered trademark of the Canadian Standards Association.

South Korean Class A EMC declaration:

Information to the user:

This equipment has been conformity assessed for use in business environments. In a residential environment this equipment may cause radio interference.

- This EMC statement applies to the equipment only for use in business environment.

사 용 자 안 내 문

이 기기는 업무용 환경에서 사용할 목적으로 적합성평가를 받은 기기로서 가정용 환경에서 사용하는 경우 전파간섭의 우려가 있습니다.

- 사용자 안내문은 “업무용 방송통신기자재”에만 적용한다.

Safety and EMC Requirements

CAUTION This electronic load is designed to comply with the following safety and EMC (Electromagnetic Compatibility) requirements:

- Low Voltage Directive
- EMC Directive

Environmental Conditions

CAUTION

The EL30000 Series is designed for indoor use. The table below shows the general environmental requirements for this instrument.

Environmental condition	Requirement
Temperature	Operating condition: 0 °C to 40 °C Storage condition: -40 °C to 70 °C
Humidity	Operating condition: Up to 85% RH at temperature up to 40 °C (non-condensing) Storage condition: Up to 90% RH (non-condensing)
Altitude	Up to 2000 m
Pollution degree	2
Installation category	II (for AC input)
Mains voltage (rms)	100 VAC to 240 VAC ±10%
Mains frequency	50/60 Hz
Acoustic noise declaration	Sound pressure: $L_p < 65$ dB(A) at operator position, $L_p < 70$ dB(A) at bystander position Sound power: $L_w < 70$ dB(A)

1 Getting Started

Product Introduction

Prepare Instrument for Use

Load Operating Modes

Programming Ranges

Installation

Remote Interface Configuration

Remote Control

Using the Built-in Help System

Firmware Update

Front Panel Menu Reference

This chapter gets you started with the EL30000 Series DC electronic loads.

Product Introduction

The EL30000 Series DC electronic loads are designed with superior performance in compact bench form factor. Ideal for design/verification of consumer power supplies, batteries, battery modules, solar panels, LED drivers, as well power converters.

The series includes single and dual inputs models:

- EL33133A: Single Input DC Electronic Load; 150 V, 40 A, 250 W
- EL34143A: Single Input DC Electronic Load; 150 V, 60 A, 350 W
- EL34243A: Dual Input DC Electronic Load; 2 x 150 V, 60 A, 300 W (total 600 W)

Features:

Clean, reliable load

- 250 to 600 W, 0 to 150 V, 0 to 60 A
- Four modes: constant voltage (CV), constant current (CC), constant power (CP), and constant resistance (CR)
- Excellent programming/readback accuracy
- High resolution
- 2-wire or 4-wire remote sense
- Over voltage, over current, and over temperature protection

Convenient benchtop capabilities

- Dynamic transient response up to 100 kHz
- Thermal-control fan speed for lower acoustic noise
- Input parallel connections (EL34243A only)
- Front and rear input terminal

Intuitive and easy to use interfaces

- 4.3-inch LCD color display
- Color-coded channels
- Individual knobs for voltage and current input
- LAN (LXI), USB, and GPIB (optional)

Advance characterization

- Scope view
- Data logging
- Input sequencing
- Low range current measurement
- Adjustable voltage slew rate

The model-specific features are shown below.

Feature	EL33133A	EL34143A	EL34243A
Power input	250 W	350 W	300 W per input, total 600 W
IO interface	USB	USB/LAN standard, GPIB optional	USB/LAN standard, GPIB optional
Maximum operating voltage/current	150 V/40 A	150 V/60 A	150 V/60 A
Digital IO		✓	✓
Scope view	✓	✓	✓
Input-parallel mode			✓
Input sequencing		✓	✓
Low range current measurement		✓	✓
Data logging	✓	✓	✓
BenchVue software	✓	✓	✓

Front panel at a glance (EL33133A/EL34143A)



Item	Description
1	Information-packed, high contrast 4.3-inch LCD color display; easily viewable even from sharp angles
2	Vertical and Horizontal knobs Use Vertical knob to set the input value for input 1. These knobs are active in Meter View, Scope View, Data Logger View, and Settings page.
3	Meter View, List Run/Stop, and Scope/Datalog keys <ul style="list-style-type: none"> – [Meter View] turns on the meter view for the selected input. – [List Run/Stop] runs or stop input sequencer list on all channels simultaneously. – [Scope/Datalog] toggles between Scope view and Data Logger view.
4	Navigation keys. – Navigate through the control dialog windows; press [Enter] key to select a control.
5	Numeric keypad <ul style="list-style-type: none"> – Enters numeric values. Press [Enter] key to complete the entry. – Deletes the values entered into the dialog using the back key.
6	Input On key Turns the input On or Off; input is on when the key is lit.
7	Sense terminals
8	Input terminals
9	Power key and LED indicator Turns on the instrument. If the LED is amber, the instrument is in standby mode with AC inlet power connected, and if it is green, the instrument is on.
10	Softkeys Accesses the soft front panel menu.
11	USB port

Item	Description
11	USB port Allows an external USB drive to be connected to the instrument.

Front panel at a glance (EL34243A)



Item	Description
1	Information-packed, high contrast 4.3-inch LCD color display; easily viewable even from sharp angles
2	Input selection keys Selects an input to control. The lit key indicates the selected input. Tip: When this key is selected, pressing this key again will toggle between multiple and single input view.
3	Vertical and Horizontal knobs Set the input value for input 1 and input 2. These knobs are active in Meter View, Scope View, Data Logger View, and Settings page.
4	Meter View, List Run/Stop, and Scope/Datalog keys <ul style="list-style-type: none"> – [Meter View] turns on the meter view for the selected input. – [List Run/Stop] runs or stop input sequencer list on all channels simultaneously. – [Scope/Datalog] toggles between Scope view and Data Logger view.
5	Navigation keys. – Navigate through the control dialog windows; press [Enter] key to select a control.
6	Numeric keypad <ul style="list-style-type: none"> – Enters numeric values. Press [Enter] key to complete the entry. – Deletes the values entered into the dialog using the back key.
7	Input On key Turns individual inputs On or Off; inputs are on when the key is lit.
8	Input terminals

Item	Description
9	Power key and LED indicator Turns on the instrument. If the LED is amber, the instrument is in standby mode with AC inlet power connected, and if it is green, the instrument is on.
10	All input on/off key Turns all inputs On and Off according to the specified turn-on and turn-off delays.
11	Softkeys Accesses the soft front panel menu.
12	USB port Allows an external USB drive to be connected to the instrument.

Rear panel at a glance (EL33133A/EL34143A)

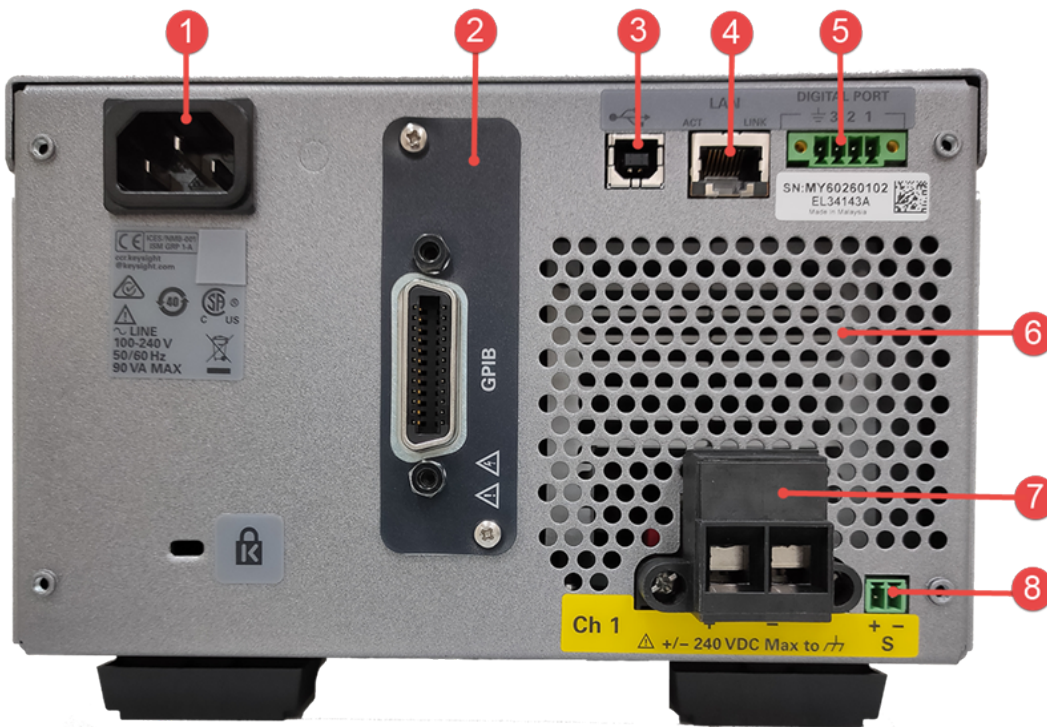

Item	Description
1	AC inlet
2	GPIB port (EL34143A only – Option GPIB)
3	USB port (EL34143A only)
4	LAN port (EL34143A only)
5	Digital I/O terminal port (EL34143A only)
6	Fan ventilation hole
7	Input 1 terminal port with mating connector
8	Input 1 sense terminal port

Rear panel at a glance (EL34243A)

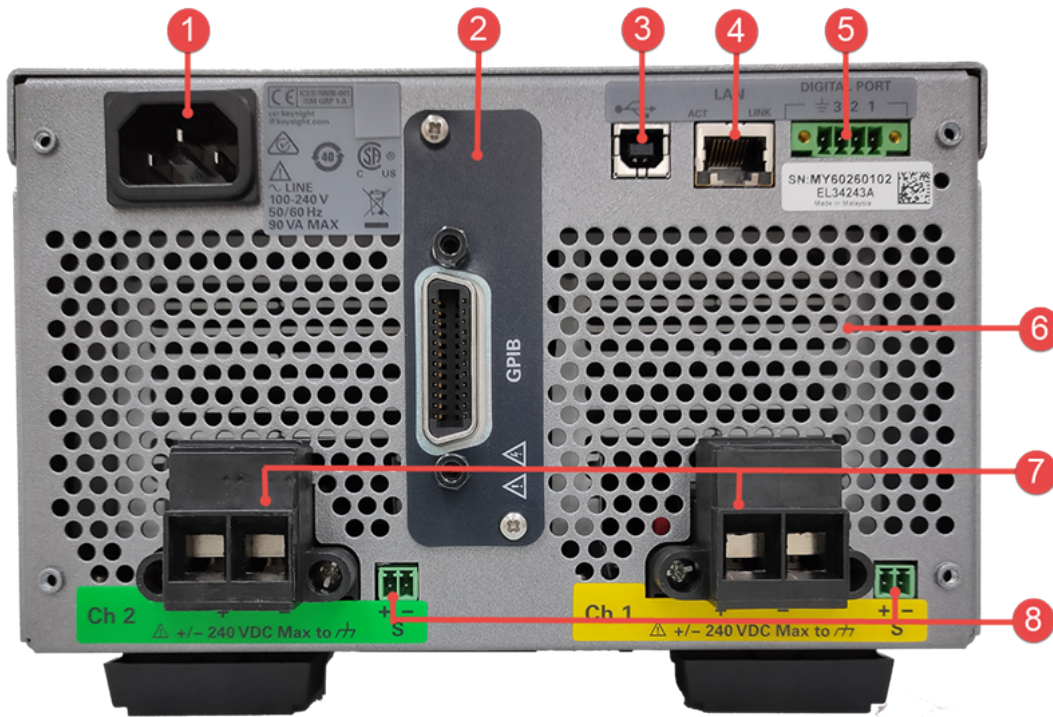

Item	Description
1	AC inlet
2	GPIB port (Option GPIB)
3	USB port
4	LAN port
5	Digital I/O terminal port
6	Fan ventilation hole
7	Input 1 and input 2 terminal ports with mating connectors
8	Input 1 and input 2 sense terminal ports

Meter view

The electronic load's front panel features a high contrast 4.3-inch LCD color display.

Press **[Meter View]**. This key toggles between multiple (EL34243A only) and single input view.

EL33133A/EL34143A

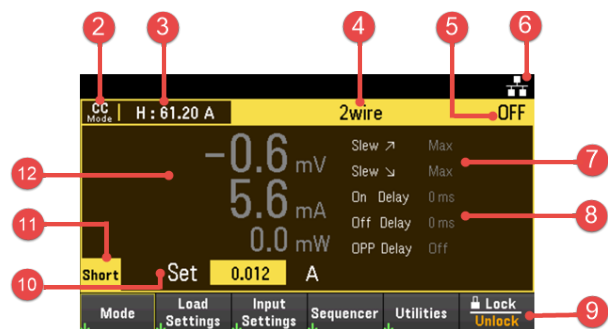

EL34243A

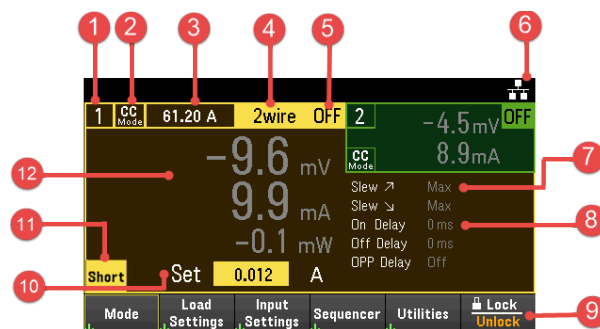

Item	Description
1	Input identifier (EL34243A only) When an input is selected, the background becomes highlighted.
2	Load operating mode identifier. Displays the selected operating mode. CV mode: Constant voltage mode CC mode: Constant current mode CP mode: Constant power mode CR mode: Constant resistance mode
3	Input range Displays the input range setting.
4	Remote sense status 2wire or 4wire indicates that 2-wire or 4-wire sensing measurement is in use.
5	Input status OFF: The input is off CV: The input is in constant voltage mode CC: The input is in constant current mode UR: The input is unregulated OV: Over-voltage protection is tripped OC: Over-current protection is tripped OT: Over-temperature protection is tripped CP: The input is in constant power mode CR: The input is in constant resistance mode CP+: Positive power limit condition has disabled the input OV-: Negative over-voltage protection is tripped UVI: Under-voltage inhibit protection is tripped Inh: The input is inhibited by an external INHibit signal SH: The input terminals are shorted
6	Interface status : The instrument is connected to USB. : The instrument is connected to LAN. (blinking): The instrument is under identification mode via remote interface. : The instrument is not connected to LAN. (blinking): The LAN connection is at fault.
7	Slew rate Displays the rising slew and falling slew rate

Item	Description
8	Input delay Displays the Over-protection delay and Input On/Off delay status/values.
9	Soft front panel menu
10	Input settings Displays the present input value settings in voltage, ampere, ohms and watts. Use the numeric keypad or turn the front panel knob to adjust these settings.
11	Input short indicator Displays when input short is enabled.
12	Input meters Displays the actual input voltage, current and power.

Data logger view

Press [**Scope/Data Log**]. This key toggles between Data Logger view and Scope view.

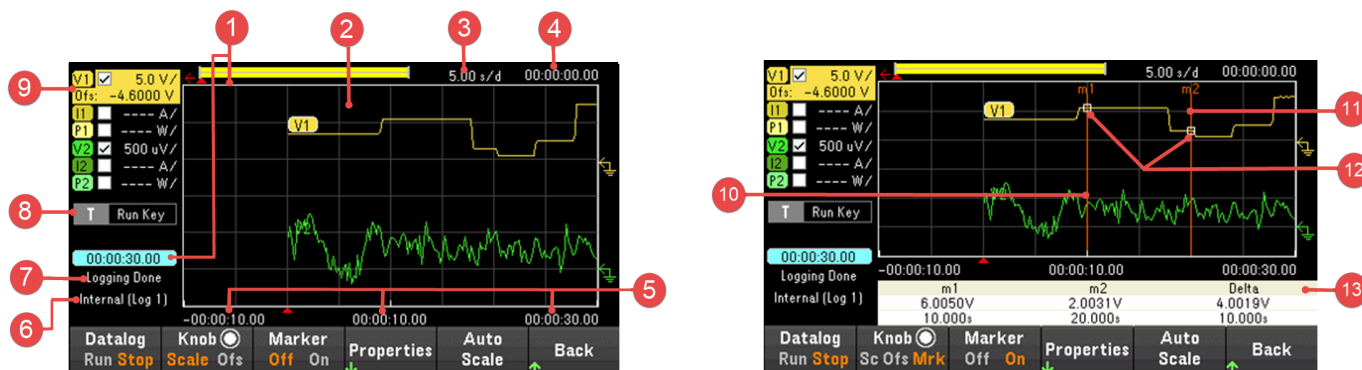

Item	Description
1	Data bar and time elapsed Displays the progress of the data logger. The yellow bar indicates the visible data. Numbers to the left indicate time elapsed/total duration.
2	Data traces Voltage, current, or power traces. Voltage traces V1 and V2 is shown. Press Auto Scale to auto scale all traces.
3	Time/Div Indicates the horizontal time-base setting.
4	Offset time Indicates the time that the right gridline is offset or away from the end of the data log.
5	Grid time Displays the time on the gridline.
6	Filename Indicates the file to which the data is being logged.
7	Status Indicates whether the Data Logger is logging data, done logging, or is empty.
8	Trigger Source Indicates the trigger source for the data logger.
9	Trace controls Identifies the voltage or current trace that will be displayed. Dashes (---) indicate that the specified trace is turned off. Select the trace and press [Enter] to turn it on or off.
10	m1 marker Measurement Marker 1 enabled. This can be adjusted using the Vertical knob after pressing Knob Mrk .
11	m2 marker Measurement Marker 2 enabled. This can be adjusted using the Horizontal knob after pressing Knob Mrk .
12	Intersect point Shows where the measurement markers intersect the waveform.
13	Measurements Shows the calculations of the waveform data between Marker 1 and Marker 2.

Scope view

Press [**Scope/Datalog**]. This key toggles between Data Logger view and Scope view.

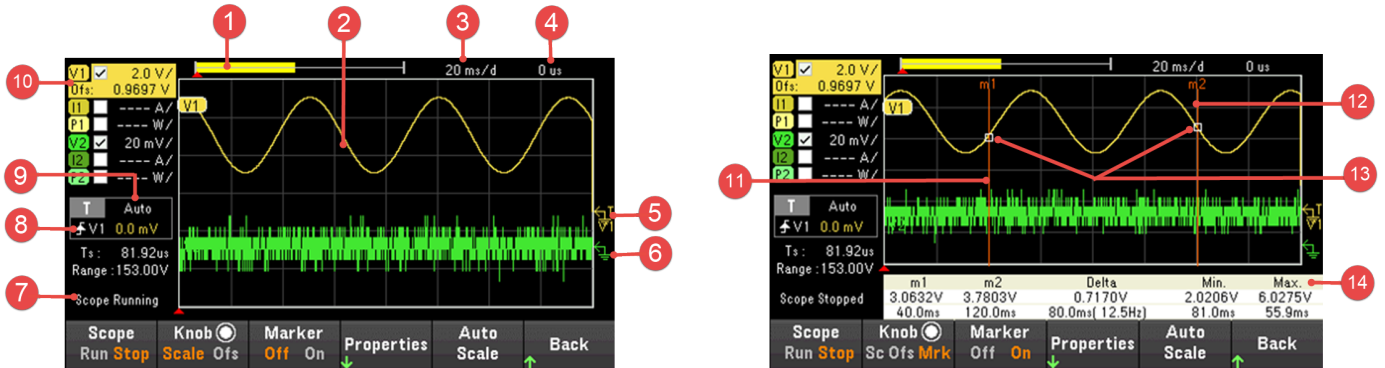

Item	Description
1	Data bar The highlighted area shows how much of the entire measurement is actually shown on the display.
2	Scope traces Voltage, current, or power traces. Voltage traces V1 and V2 is shown for EL34243A. Press Auto Scale to auto scale all traces.
3	Time/Div Indicates the horizontal time-base setting. This can be adjusted using the Horizontal knob after pressing Knob Scale .
4	Offset time Indicates the time from the trigger point indicator to the horizontal reference. Negative values indicate horizontal reference is to the left of the trigger point. Positive values indicate the horizontal reference is to the right of the trigger point.
5	Trigger level Identifies the trigger level through which the waveform must pass before the scope will trigger.
6	Ground Identifies the ground reference level for the trace. The initial vertical offset of each trace is set to a different level to prevent the traces from overlapping.
7	Scope status Indicates whether the scope is idle, running, or waiting for a trigger.
8	Trigger source Identifies the trigger source and trigger level. V1 indicates a voltage level on input 1 is the trigger source.
9	Trigger mode Identifies the trigger mode setting. This can be selected by pressing Properties > Settings .
10	Trace controls Identifies the voltage, current, or power trace that will be displayed. Dashes (----) indicate that the specified trace is turned off. Select the trace and press [Enter] to turn it on or off.
11	m1 marker Measurement Marker 1 enabled. This can be adjusted using the Vertical knob after pressing Knob Mrk .
12	m2 marker Measurement Marker 2 enabled. This can be adjusted using the Horizontal knob after pressing Knob Mrk .

Item	Description
13	Intersect point Shows where the measurement markers intersect the waveform.
14	Measurements Shows the calculations of the waveform data between Marker 1 and Marker 2.

Dimension diagram

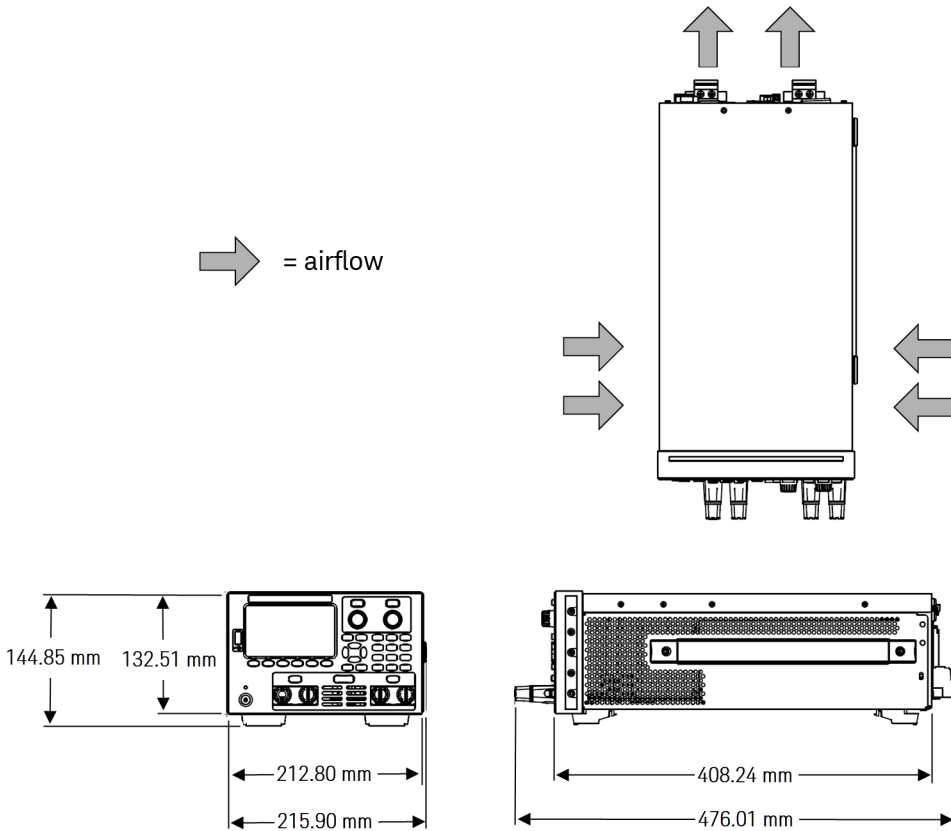

Setup the instrument

Place the instrument's feet on a flat, smooth horizontal surface. Connect input to the front panel or connect input and sense leads to the rear panel, being careful not to short the leads together. Attach the power cable to the rear panel, then plug it into main power. Connect LAN, USB, or GPIB cables as desired, and you may also secure the instrument with a security lock cable.

Before disconnecting cables and cords from the instrument, turn the instrument off using the front-panel **[Power]** key and disconnect from the supply source by unplugging the detachable power cord.

Prepare Instrument for Use

Initial inspection

When you receive your instrument, inspect it for any obvious damage that may have occurred during shipment. If there is damage, notify the shipping carrier and nearest Keysight Sales and Support Office immediately. Refer to www.keysight.com/find/assist.

Until you have checked out the instrument, save the shipping carton and packing materials in case the unit has to be returned. Check the list under **Standard Shipped Items** and verify that you have received these items with your instrument. If anything is missing, please contact your nearest Keysight Sales and Support Office.

Standard shipped items

- Keysight **EL33133A**/EL34143A/EL34243A DC electronic load
- AC power cord
- Certificate of calibration

Shipped with the EL34143A models:

- One 10 A, 3.5 mm female 4-pin terminal I/O block connector
- One 8 A, 3.5 mm 2-pin terminal sense block connector
- One 85 A, 12 mm 2-pin mating connector

Shipped with the EL34243A model:

- One 10 A, 3.5 mm female 4-pin terminal I/O block connector
- Two 8 A, 3.5 mm 2-pin terminal sense block connector
- Two 85 A, 12 mm 2-pin mating connector

Documentation and firmware revisions

The Keysight EL30000 Series documentation listed below can be downloaded for free through our website at www.keysight.com/find/el30000.

- Keysight EL30000 Series DC Electronic Load User's Guide. This manual.
- Keysight EL30000 Series DC Electronic Load Programming Guide
- Keysight EL30000 Series DC Electronic Load Service Guide

For the latest firmware revision and firmware update instruction, go to www.keysight.com/find/el30000.

Recommended calibration interval

Keysight Technologies recommends a one-year calibration cycle for the EL30000 Series DC electronic load.

Load Operating Modes

The load operating modes for Keysight EL30000 Series DC electronic load are:

- Constant current (CC) mode
- Constant voltage (CV) mode
- Constant power (CP) mode
- Constant resistance (CR) mode

When programmed to a mode, the electronic load remains in that mode until the mode is changed or until a fault condition, such as an overpower or over-temperature occurs.

CC mode

In this mode, the load unit will sink a current in accordance with the programmed value regardless of the input voltage.

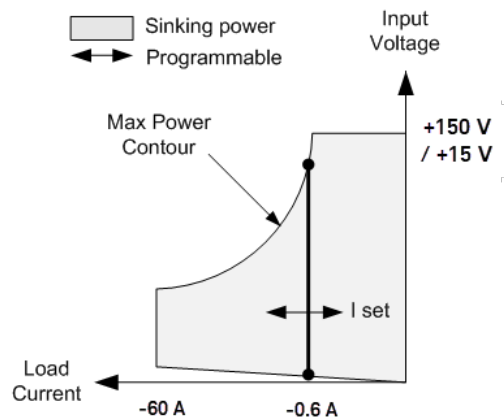

The heavy solid vertical line illustrates the locus of possible operating points as a function of the load current. A CC (constant current) status flag indicates that the load current is at the specified setting. A voltage limit is not programmable in CC mode. Also, if the DUT imposes a voltage that is above 110% of the rated input voltage, the overvoltage protection will trip and the load's input will turn off.

Current may be programmed in one of three overlapping ranges, a Low, Medium and a High current range. The low range provides better programming and measurement resolution at low current settings.

CV mode

In this mode, the load unit will attempt to sink enough current to maintain the input voltage at its programmed value.

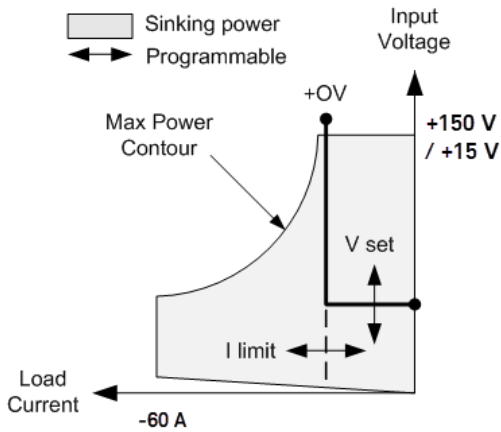

The heavy solid line illustrates the locus of possible operating points as a function of the load voltage. Note that in CV mode, a current limit can be imposed. As shown by the horizontal portion of the line, the input voltage remains regulated at its programmed setting as long as the input current remains within the current limit setting. A CV (constant voltage) status flag indicates that the input current is within the limit settings.

When the input current reaches the current limit, the unit is no longer in constant voltage operation and the input voltage is no longer held constant. Instead, the load unit will now regulate the input current at its current limit setting. A CL (current limit) status flag is set to indicate that a current limit has been reached. If the input voltage increases until it exceeds 110% of the rated input voltage, the overvoltage protection will trip and the load's input will turn off.

Voltage may be programmed in one of two overlapping ranges, a Low and a High range. The low range provides better programming and measurement resolution at low voltage settings.

CP mode

In this mode, the load unit will regulate the power being drawn from the DUT according to the programmed constant-power value.

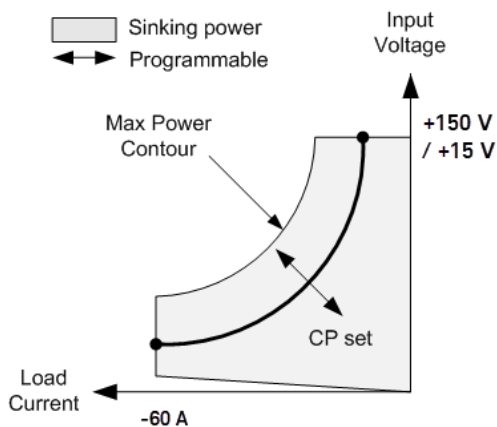

The load unit regulates the input power by measuring the input voltage and current and adjusting the input power based on data streamed from the measurement ADCs.

Power may be programmed in one of three overlapping ranges, a Low, Medium and a High power range. The low range provides better programming and measurement resolution at low power settings. The load unit have a built-in over-power protection function that will not let you exceed 110% of the power rating of the load module (the Max Power Contour).

CR mode

In this mode, the load unit will sink current proportional to the input voltage in accordance with the programmed resistance.

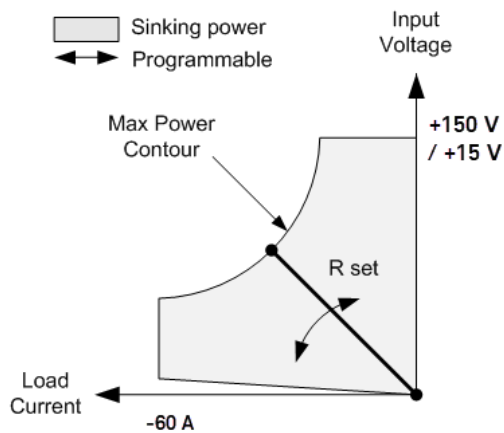

The heavy solid line illustrates the locus of possible operating points as a function of the resistance. Resistance may be programmed in one of three overlapping ranges - a Low, Medium, and a High resistance range. The lower ranges provide better programming and measurement resolution at lower resistance settings. The load unit automatically selects the resistance range that best corresponds to the resistance value that you program. If the resistance value falls in a region where ranges overlap, the load selects the range with the highest resolution for the resistance value.

Programming Ranges

The following table shows the input ranges (voltage, current, power and resistance) and its default value that can be programmed for each model in EL30000 Series.

Operating Mode	Range		EL33133A	EL34143A	EL34243A	
CV	High	MAXimum	153 V	153 V	Single/Parallel: 153 V	
		MINimum	0.02 V	0.015 V	Single/Parallel: 0.015 V	
	Low	MAXimum	15.3 V	15.3 V	Single/Parallel: 15.3 V	
		MINimum	0.005 V	0.003 V	Single/Parallel: 0.003 V	
	DEFAult (*RST)		0.02 V	0.015 V	Single/Parallel: 0.015 V	
CC	High	MAXimum	40.8 A	61.2 A	Single: 61.2 A Parallel: 122.4 A	
		MINimum	0.01 A	0.012 A	Single: 0.012 A Parallel: 0.024 A	
	Medium	MAXimum	-	6.12 A	Single: 6.12 A Parallel: 12.24 A	
		MINimum	-	0.002 A	Single: 0.002 A Parallel: 0.004 A	
	Low	MAXimum	4.08 A	0.612 A	Single: 0.612 A Parallel: 1.224 A	
		MINimum	0.001 A	0.0002 A	Single: 0.0002 A Parallel: 0.0004 A	
	DEFAult (*RST)		0.01 A	0.012 A	0.012 A	
	CP	High	MAXimum	255 W	357 W	Single: 306 W Parallel: 612 W
			MINimum	1.5 W	2 W	Single: 2 W Parallel: 4 W
		Medium	MAXimum	25.5 W	35.7 W	Single: 30.6 W Parallel: 61.2 W
MINimum			0.15 W	0.3 W	Single: 0.2 W Parallel: 0.4 W	
Low		MAXimum	5.1 W	8.16 W	Single: 7.14 W Parallel: 14.28 W	
		MINimum	0.02 W	0.01 W	Single: 0.01 W Parallel: 0.02 W	
DEFAult (*RST)			1.5 W	2 W	2 W	

Operating Mode	Range		EL33133A	EL34143A	EL34243A	
CR	Ultra-High	MAXimum	-	100 k Ω	Single: 100 k Ω Parallel: 50 k Ω	
		MINimum	-	250 Ω	Single: 250 Ω Parallel: 125 Ω	
	High	MAXimum	4 k Ω	4000 Ω	Single: 4000 Ω Parallel: 2000 Ω	
		MINimum	100 Ω	100 Ω	Single: 100 Ω Parallel: 50 Ω	
	Medium	MAXimum	1.25 k Ω	1250 Ω	Single: 1250 Ω Parallel: 625 Ω	
		MINimum	10 Ω	10 Ω	Single: 10 Ω Parallel: 5 Ω	
	Low	MAXimum	30 Ω	30 Ω	Single: 30 Ω Parallel: 15 Ω	
		MINimum	0.08 Ω	0.05 Ω	Single : 0.05 Ω Parallel: 0.025 Ω	
	DEFault (*RST)			4 k Ω	100 k Ω	100 k Ω

Installation

Connecting the power cord

Connecting the inputs

Parallel connections

4-wire sense connection

Interface connections

Installing the optional GPIB interface

Rackmounting the instrument

Connecting the power cord

WARNING

FIRE HAZARD

Use only the power cord that was supplied with your instrument. Using other types of power cords may cause overheating of the power cord, resulting in fire and electric shock hazard.

SHOCK HAZARD

The power cord provides a chassis ground through a third conductor. Be certain that your power outlet is of the three-conductor type with the correct pin connected to earth ground.

Connect the power cord to the AC inlet connector on the rear of the unit. If the wrong power cord was shipped with your unit, contact your nearest Keysight Sales and Support Office.

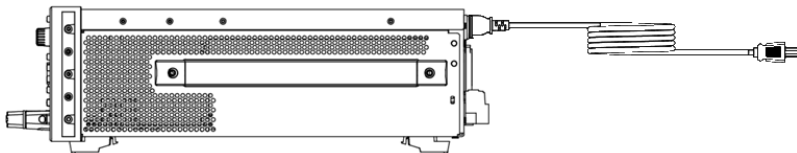

Removing the power cord will disconnect AC input power to the unit.

Connecting the inputs

WARNING

SHOCK HAZARD

The input terminal is designed for DC application. Ensure that transient voltages do not exceed 480 V_{PK} or 480 V_{DC}.

SHOCK HAZARD

Floating voltage must not exceed 240 V_{DC}. The total voltage on the input terminal and the floating voltage must not be more than 240 V_{DC} from chassis ground.

DO NOT CONNECT FRONT AND REAR INPUT TERMINAL CONCURRENTLY

Do not connect the front and rear input terminal concurrently for the same input channel. When the front input terminal is in used, the rear input terminal must be left unused. Failing to observe the connection requirement could potentially raise a fire hazard if the input current exceeding 60 A.

DO NOT REMOVE THE MATING CONNECTOR

Do not remove the rear mating connector as it acts as safety cover to the rear input terminal.

All DUTs should either be connected to the front panel binding post or rear panel input.

Binding posts

WARNING

SHOCK HAZARD

Turn off AC power before connecting wires to the front panel. All wires and straps must be properly connected with the binding posts securely tightened.

SHOCK HAZARD

To prevent accidental contact with hazardous voltages, do not extend the wire beyond the contact area inside the input connector.

The binding posts accept wires sizes up to AWG 6 in location (A).

Wire size AWG 6 or 8 is the recommended wire. If you are connecting more than one wire on each binding post, twist the wires to ensure a good contact and securely fasten all wires by hand-tightening the binding posts. If you are using a slotted screwdriver, tighten the binding post to 8 in-lb (90 N-cm) for a secure connection.

Maximum current rating:

(A) = 60 A

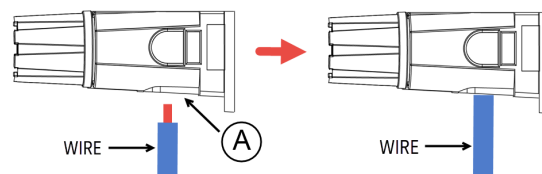

Rear inputs connections

WARNING

SHOCK HAZARD

Turn off AC mains before connecting wires to the rear panel. All wires and straps must be properly connected with the terminal block screws securely tightened.

SHOCK HAZARD

Floating voltage must not exceed 240 V_{DC}. The total voltage on the input terminal and the floating voltage must not be more than 240 V_{DC} from chassis ground.

DO NOT REMOVE THE MATING CONNECTOR

Rear input terminal connection must be performed with the presence of mating connector.

The mating connector accepts wires sizes from AWG 14 to AWG 6. The mating connector is 60 A rated for the EL34143A and EL34243A. Wire sizes smaller than AWG 14 are not recommended. Connect the DUT wires to the + and - terminals. Connect the sense wires to the +s and -s terminals.

Securely fasten all wires by tightening the screw terminals.

Part number information for the connector kit is provided under [Standard Shipped Items](#).

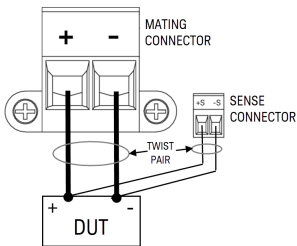

Wire sizing

WARNING

FIRE HAZARD

Select a wire size large enough to carry short-circuit current without overheating (refer to the following table). To satisfy safety requirements, load wires must be heavy enough not to overheat while carrying the short-circuit output current of the DUT connected to electronic load.

AWG	Ampacity ¹ (A)	Resistance ² (Ω/m)
14	25	0.0103
12	30	0.0065
10	40	0.0041
8	60	0.0025
6	80	0.0016
4	105	0.0010
2	140	0.00064

AWG	Ampacity ¹ (A)	Resistance ² (Ω /m)
1/0	195	0.00040
2/0	225	0.00032
3/0	260	0.00025
4/0	300	0.00020

Notes:

1. Ampacity is based on 30 °C ambient temperature with conductor rated at 60 °C. For ambient temperature other than 30 °C, multiply the above ampacities by the following constants:

Temperature (°C)	Constant
21 - 25	1.08
26 - 30	1.00
31 - 35	0.91
36 - 40	0.82
41 - 45	0.71
46 - 50	0.58
51 - 55	0.41

2. Resistance is nominal at 75 °C wire temperature.

Parallel connections (EL34243A only)

CAUTION

Equipment Damage

Only connect inputs that have identical voltage and current ratings in parallel. Keysight EL30000 Series electronic loads can be paralleled, but ONLY when operated in CC, CR and CP mode. CV mode is not allowed.

WARNING

SHOCK HAZARD

Floating voltage must not exceed 240 V_{DC}. The total voltage on the input terminal and the floating voltage must not be more than 240 V_{DC} from chassis ground.

Do not perform series connection on the input terminal.

Connecting inputs in parallel provides a greater power dissipation than that which can be achieved from a single input.

Each input will dissipate the power it has been programmed for. For example, if two inputs are connected in parallel (with input 1 programmed for 30 A), input 1 and input 2 will draw 15 A respectively.

The following figures show how to connect two inputs when in Input-Parallel mode.

Front panel

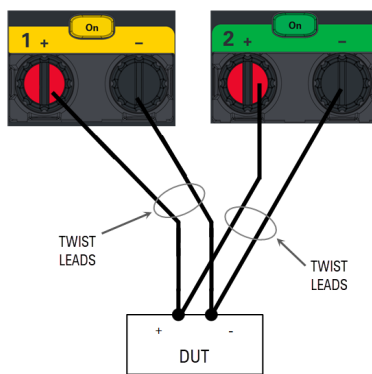

Rear panel

The figure on the left illustrates 2-wire sensing. If voltage drop in the load leads is a concern, the figure on the right shows how to connect the sense leads directly at the DUT.

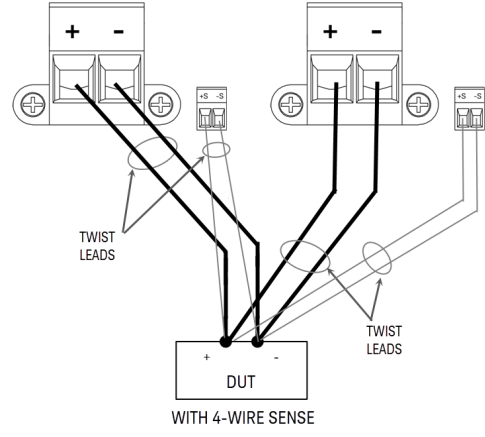
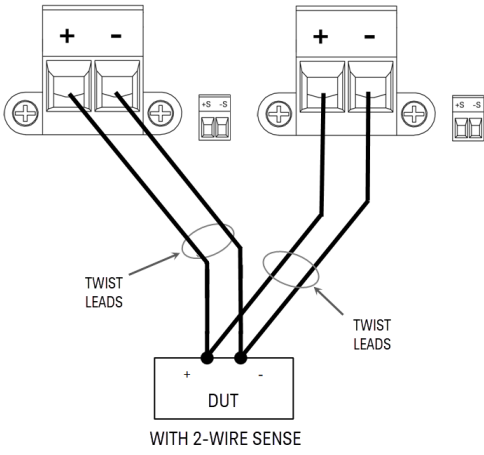

4-wire sense connection

WARNING

SHOCK HAZARD

Turn off AC mains before making rear panel connections. All wires and straps must be properly connected with the terminal block screws securely tightened.

SHOCK HAZARD

Floating voltage must not exceed 240 V_{DC}. The total voltage on the input terminal and the floating voltage must not be more than 240 V_{DC} from chassis ground.

The electronic load includes built-in relays that connect or disconnect the \pm sense terminals from their corresponding \pm input terminals. As shipped, the sense terminals are internally connected to the input terminals. This is referred to as 2-wire, or local sensing.

4-wire, or remote sensing improves the voltage regulation at the load by monitoring the voltage at the DUT rather than at the load input terminals. This automatically compensates for the voltage drop in the load leads, which is especially useful for CV operation with load impedance that vary or have significant lead resistance. Remote voltage sensing also provides greater accuracy when using voltage readback in all operating modes. Because remote sensing is independent of other load functions, it can be used regardless of how the instrument is programmed. Remote sensing has no effect during CC operation.

The following figures illustrate DUT connections using 2-wire sensing and 4-wire sensing.

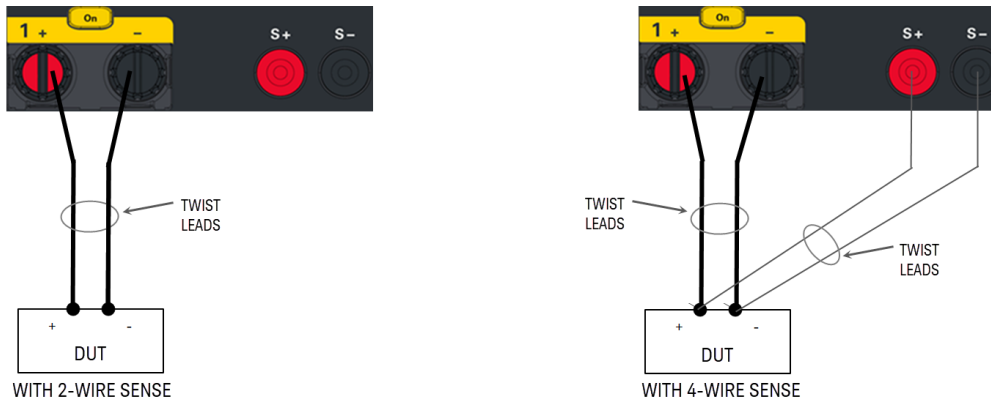

Connect the DUT to the input terminals using separate connecting wires. Keep the wire-pair as short as possible and twist or bundle it to reduce lead inductance and noise pickup. Keep the load leads under 14.7 meters (50 feet) per lead because of inductance effects.

Connect the sense leads as close to the DUT as possible. Do NOT bundle the sense wire-pair together with the load leads; keep the load wires and sense wires separate. The sense leads carry only a few milliamperes of current and can be a lighter gauge than the load leads. However, any voltage drop in the sense leads can degrade the voltage regulation of the instrument.

After turning the unit on, activate 4-wire remote voltage sensing by pressing **Source Settings** > **Sense 4w**. Refer to [Specifying 2-Wire or 4-Wire Sense](#).

Open sense leads

The sense leads are part of the input's feedback path. Connect them in such a way so that they do not inadvertently become open circuited. The electronic load includes protection resistors that reduce the effect of open sense leads during 4-wire-sensing. If the sense leads open during operation, the electronic load returns to the local sensing mode, with the voltage at the input terminals approximately 5% higher than the programmed value.

Over-voltage protection considerations

You must take into account any voltage drop in the load leads when setting the over-voltage trip point. This is because the OVP circuit senses at the input terminals and not at the sense terminals. Due to the voltage drop in the load leads, the voltage sensed by the OVP circuit could be lower than the voltage being regulated at the DUT.

Output noise considerations

Any noise picked up on the sense leads will appear at the input terminals and may adversely affect CV load regulation. Twist the sense leads or use a ribbon cable to minimize the pickup of external noise. In extremely noisy environments it may be necessary to shield the sense leads. Ground the shield at the electronic load end only; do not use the shield as one of the sensing conductors.

Interface connections

GPIB connections

USB connections

LAN connections - site and private

Digital port connections

This section describes how to connect to the various communication interfaces on your electronic load. For further information about configuring the remote interfaces, refer to [Remote Interface Configuration](#).

NOTE

If you have not already done so, install the Keysight IO Libraries Suite, which can be found at www.keysight.com/find/iolib. For detailed information about interface connections, refer to the Keysight Technologies USB/LAN/GPIB Interfaces Connectivity Guide included with the Keysight IO Libraries Suite.

GPIB connections (optional)

The following figure illustrates a typical GPIB interface system.

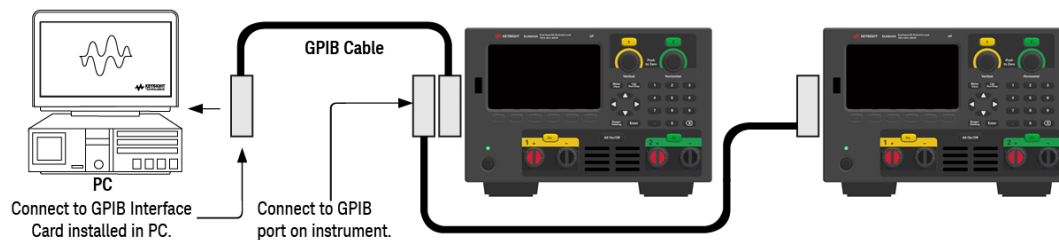

1. If you do not have a GPIB interface card installed on your computer, turn off your computer and install the GPIB card.
2. Connect your instrument to the GPIB interface card using a GPIB interface cable.
3. Use the Connection Expert utility of the Keysight IO Libraries Suite to configure the GPIB card's parameters.
4. The electronic load is shipped with its GPIB address set to 5. Use the front panel menu if you need to change the GPIB address.
5. You can now use Interactive IO within the Connection Expert to communicate with your instrument, or you can program your instrument using the various programming environments.

USB connections

The following figure illustrates a typical USB interface system.

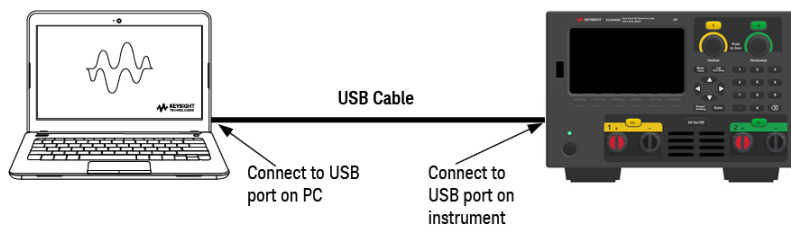

1. Connect your instrument to the USB port on your computer using a USB cable.
2. With the Connection Expert utility of the Keysight IO Libraries Suite running, the computer will automatically recognize the instrument. This may take several seconds. When the instrument is recognized, your computer will display the VISA alias, IDN string, and VISA address. This information is located in the USB folder. You can also view the instrument's VISA address from the front panel menu.
3. You can now use Interactive IO within the Connection Expert to communicate with your instrument, or you can program your instrument using the various programming environments.

NOTE

The USB cable is not recommended to be longer than 3 meters.

LAN connections - site and private

A **site LAN** is a local area network in which LAN-enabled instruments and computers are connected to the network through routers, hubs, and/or switches. They are typically large, centrally-managed networks with services such as DHCP and DNS servers. The following figure illustrates a typical site LAN system.

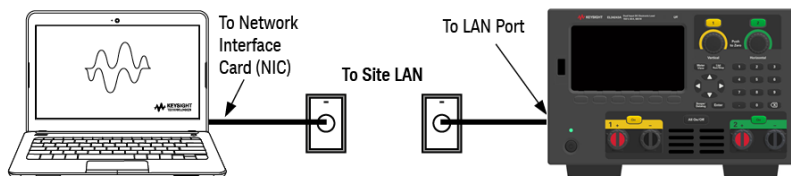

1. Connect the instrument to the site LAN or to your computer using a LAN cable. The as-shipped instrument LAN settings are configured to automatically obtain an IP address from the network using a DHCP server (DHCP is ON by default). The DHCP server will register the instrument's hostname with the dynamic DNS server. The hostname as well as the IP address can then be used to communicate with the instrument. The front panel **LAN** indicator will come on when the LAN port has been configured.

NOTE

If you need to manually configure any instrument LAN settings, refer to [Remote Interface Configuration](#) for information about configuring the LAN settings from the front panel of the instrument.

2. Use the Connection Expert utility of the Keysight IO Libraries Suite to add the electronic load and verify a connection. To add the instrument, you can request the Connection Expert to discover the instrument. If the instrument cannot be found, add the instrument using its hostname or IP address.

NOTE

If this does not work, refer to “Troubleshooting Guidelines” in the Keysight Technologies USB/LAN/GPIB Interfaces Connectivity Guide included with the Keysight IO Libraries Suite.

3. You can now use Interactive IO within the Connection Expert to communicate with your instrument, or you can program your instrument using the various programming environments. You can also use the Web browser on your computer to communicate with the instrument as described under **Remote Control**.

A **private LAN** is a network in which LAN-enabled instruments and computers are directly connected, and not connected to a site LAN. They are typically small, with no centrally-managed resources. The following figure illustrates a typical private LAN system.

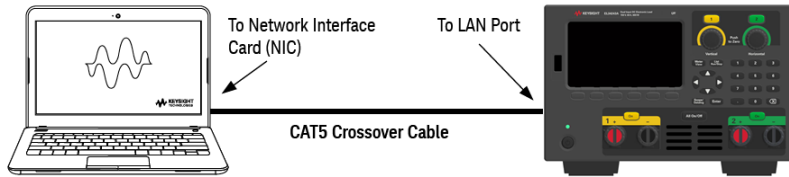

1. Connect the instrument to the computer using a LAN crossover cable. Alternatively, connect the computer and the instrument to a standalone hub or switch using regular LAN cables.

NOTE

Make sure your computer is configured to obtain its address from DHCP and that NetBIOS over TCP/IP is enabled. Note that if the computer had been connected to a site LAN, it may still retain previous network settings from the site LAN. Wait one minute after disconnecting it from the site LAN before connecting it to the private LAN. This allows Windows to sense that it is on a different network and restart the network configuration.

2. The factory-shipped instrument LAN settings are configured to automatically obtain an IP address from a site network using a DHCP server. You can leave these settings as they are. Most Keysight products and most computers will automatically choose an IP address using auto-IP if a DHCP server is not present. Each assigns itself an IP address from the block 169.254.nnn. Note that this may take up to one minute. The front panel LAN indicator will come on when the LAN port has been configured.

NOTE

Turning off DHCP reduces the time required to fully configure a network connection when the electronic load is turned on. To manually configure the instrument LAN settings, refer to **Remote Interface Configuration** for information about configuring the LAN settings from the front panel of the instrument.

3. Use the Connection Expert utility of the Keysight IO Libraries Suite to add the electronic load and verify a connection. To add the instrument, you can request the Connection Expert to discover the instrument. If the instrument cannot be found, add the instrument using its hostname or IP address.

NOTE

If this does not work, refer to “Troubleshooting Guidelines” in the Keysight Technologies USB/LAN/GPIB Interfaces Connectivity Guide included with the Keysight IO Libraries Suite.

4. You can now use Interactive IO within the Connection Expert to communicate with your instrument, or you can program your instrument using the various programming environments. You can also use the Web browser on your computer to communicate with the instrument as described under **Remote Control**.

Digital port connections

A 4-pin connector is provided on each instrument to access the three digital control port functions. The digital control connector accepts wire sizes from AWG 16 to AWG 22.

NOTE

It is good engineering practice to twist and shield all signal wires to and from the digital connectors. If shielded wire is used, connect only one end of the shield to the chassis ground to prevent ground loops.

The wire connection to the digital port is not recommended to be longer than 3 meters.

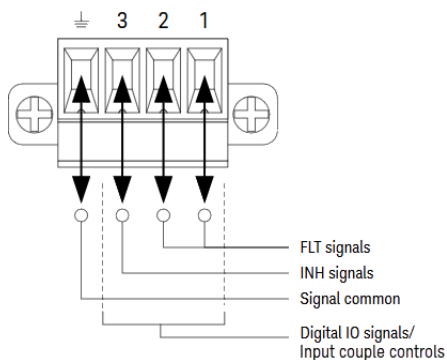

Pin functions

The following table describes the possible pin configuration for the digital port functions. For a complete description of the electrical characteristics of the digital I/O port, refer to the product data sheet.

Pin function	Available configurable pins
Digital I/O and Digital In	Pins 1 through 3
External Trigger In/Out	Pins 1 through 3
Fault Out	Pin 1 and Pin 2
Inhibit In	Pin 3
Input Coupling	Pins 1 through 3
Common	Pin 4

In addition to the configurable pin functions, the active signal polarity for each pin is also configurable. When Positive polarity is selected, a logical true signal is a voltage high at the pin. When Negative polarity is selected, a logical true signal is a voltage low at the pin.

For more information on configuring the digital port functions, refer to [Using the Digital Control Port](#).

Installing the optional GPIB interface (EL34143A and EL34243A only)

WARNING

TURN OFF POWER AND REMOVE ALL CONNECTIONS PRIOR TO INSTALLATION

Turn off the power and remove all connections, including the power cord, from the instrument prior installation of the GPIB interface.

RETAIN GPIB COVER PLATE

After installing the GPIB option, retain the cover plate for use in the event that you ever remove the GPIB option. The instrument should never be connected to AC mains or input terminal when the rear-panel opening is not securely covered with either GPIB module or the cover plate.

The following tools are required.

- Torx screwdriver

Make sure you turn the electronic load upside down before proceeding.

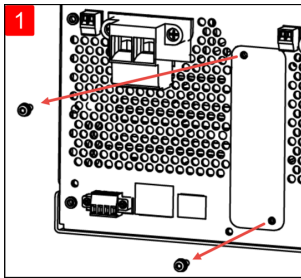

Use a Torx screwdriver to remove the M3 screws from the GPIB cover plate. Retain the screws for use later in this procedure.

Then, remove the cover plate.

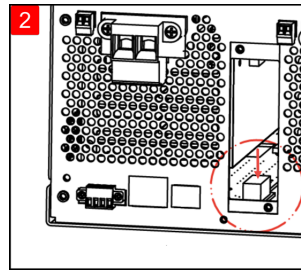

Locate the connector, just inside the unit, to connect the cable that is attached to the GPIB module.

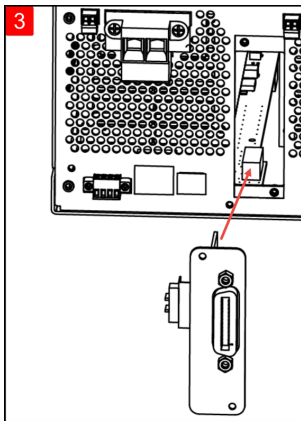

Attach the cable to the connector located in the previous step.

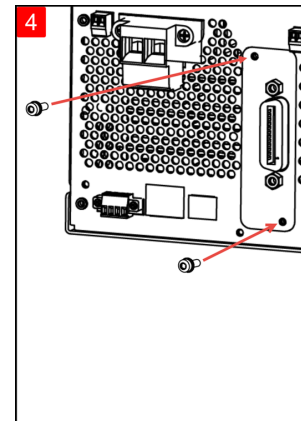

Put the module into the unit. Use the screws that was removed earlier to secure the GPIB plate in place.

This concludes the GPIB installation procedure.

Rack mounting the instrument

WARNING

DO NOT BLOCK VENTILATION HOLES

Do not block the rear ventilation hole and keep at least 130 mm free space from the rear panel.

CAUTION

To prevent overheating, do not block airflow to or from the instrument. Allow enough clearance at the rear, sides, and bottom of the instrument to permit adequate internal air flow.

NOTE

Use the Rack Mount kit as stated below to rack mount the instrument. Installation instructions are provided with the rack mount kit.

The electronic load can be mounted in a standard 19-inch rack cabinet. They are designed to fit in three rack-units (3U) of space.

Remove the feet before rack mounting the unit. Do not block the air intake and exhausts at the sides and rear of the unit.

Rack mounting a single instrument

To rack mount a single instrument, order adapter kit (1CM116A).

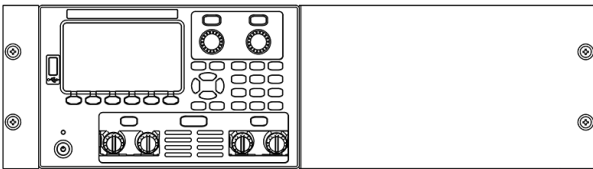

Rack mounting instruments side-by-side

To rack mount two instruments side-by-side, order lock-link kit (5061-8769). Be sure to use the support rails in the rack cabinet.

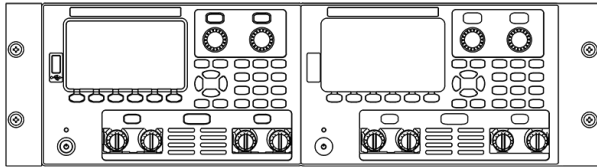

Rackmount kit without handles (1CM104A)

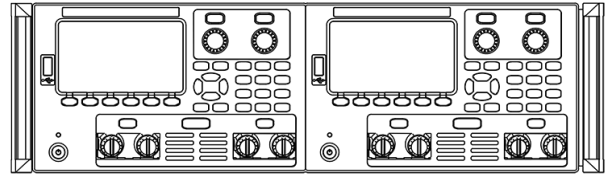

Front handle kit (1CN107A)

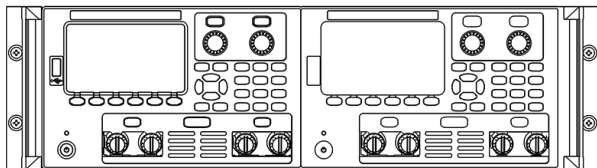

Rackmount kit with handles (1CP108A)

Remote Interface Configuration

The instrument supports remote interface communication over three interfaces: USB, GPIB, and LAN.

- USB Interface: Use the rear-panel USB port to communicate with your PC.
- GPIB Interface: Set the instrument's GPIB address and connect to your PC using a GPIB cable.
- LAN Interface: By default, DHCP is on, which may enable communication over LAN. The acronym DHCP stands for Dynamic Host Configuration Protocol, a protocol for assigning dynamic IP addresses to networked devices. With dynamic addressing, a device can have a different IP address every time it connects to the network.

Keysight IO Libraries Suite

NOTE

Ensure that the Keysight IO Libraries Suite is installed before you proceed for the remote interface configuration.

Keysight IO Libraries Suite is a collection of free instrument control software that automatically discovers instruments and allows you to control instruments over LAN, USB, GPIB, RS-232, and other interfaces. For more information, or to download IO Libraries, go to www.keysight.com/find/iosuite.

GPIB configuration

NOTE

There are no SCPI commands to configure the GPIB parameter. All GPIB configuration must be done from the front panel.

Each device on the GPIB (IEEE-488) interface must have a unique whole number address between 0 and 30. The instrument ships with a default address of 5.

- This setting is non-volatile; it will not be changed by power cycling or *RST or SYSTEM:PRESet.
 - Your computer's GPIB interface card address must not conflict with any instrument on the interface bus.
1. Press **Utilities** > **I/O Config** > **GPIB** to access the GPIB window.
 2. From this window, you can set the GPIB address using the numeric keys and press **[Enter]**.
 3. Press **Back** to exit.

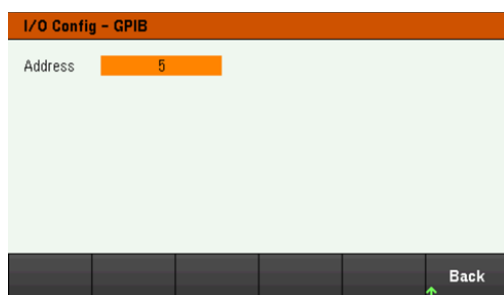

LAN configuration

The following sections describe the primary front panel LAN configuration functions on the front-panel menu.

NOTE

There are no SCPI commands to configure the LAN parameters. All LAN configuration must be done from the front panel.

After changing the LAN settings, you must save the changes. Press Back once you have completed the changes. You will be prompted to press Yes to save the LAN setting or No to exit without saving. Press Yes cycles power to the instrument and activates the settings. LAN settings are nonvolatile, they will not be changed by power cycling or *RST. If you do not want to save your changes, press No to cancel all changes.

When shipped, DHCP is on, which may enable communication over LAN. The acronym DHCP stands for Dynamic Host Configuration Protocol, a protocol for assigning dynamic IP addresses to devices on a network. With dynamic addressing, a device can have a different IP address every time it connects to the network.

Some LAN settings require you to cycle instrument power to activate them. The instrument briefly displays a message when this is the case, so watch the screen closely as you change LAN settings.

Viewing the LAN status

Press **Utilities** > **I/O Config** > **LAN Status** to view the LAN status.

The LAN status may be different from the front panel configuration menu settings - depending on the configuration of the network. If the settings are different, it is because the network has automatically assigned its own settings.

I/O Config - LAN Status			
LAN Status:	Running	DNS(1) Addr:	141.183.230.30
IP Source:	DHCP	DNS(2) Addr:	141.183.236.41
IP Addr:	10.82.100.98	TCPIP Port:	5025
Subnet Mask:	255.255.248.0	Telnet Port:	5024
Gateway:	10.82.96.1	MAC Addr:	00:30:D3:1F:49:0C
Host Name:			
Domain Name:			
VISA Addr:	TCPIP::10.82.100.98::inst0::INSTR		
mDNS Service:	Keysight EL34243A DC Electronic Load - MY20201905		
mDNS Hostname:	K-EL34243A-0190.local		

LAN Restart	LAN Reset				Back
-------------	-----------	--	--	--	------

Restarting the LAN

Press **Utilities** > **I/O Config** > **LAN Status** > **LAN Restart** restarts the networking using ALL current LAN settings. LAN restart does not clear the Web interface password.

Resetting the LAN

Press **Utilities** > **I/O Config** > **LAN Settings** > **Set to Default** resets the LAN settings to their factory default values. All default LAN settings are listed under Non-volatile Settings in Programming Guide.

Press **Utilities** > **I/O Config** > **LAN Status** > **LAN Reset** resets the LAN using its current settings and enables DHCP and DNS. The **LAN Reset** softkey also clears any user-defined Web Interface password.

Modifying the LAN settings

As shipped from the factory, the instrument pre-configured settings should work in most LAN environments. Refer to Non-Volatile Settings in the Programming Guide for information on the factory-shipped LAN settings.

Press **Utilities** > **I/O Config** > **LAN Settings** to access the LAN Settings window. From this menu, you can manually configure the LAN settings.

I/O Config - LAN Setting			
IP Source	DHCP	AutoDNS	On
IP Address	192.168.10.1	DNS(1) Addr	0.0.0.0
Subnet Mask	255.255.255.0	DNS(2) Addr	0.0.0.0
Gateway	192.168.10.1		
DNS Hostname	K-EL34243A-0190		
mDNS	On		
mDNS Service	Keysight EL34243A DC Electronic Load - MY20201E		
DHCP	AutoDNS	mDNS	Set to
Off On	Off On	Off On	Default
			Back

DHCP

DHCP (Dynamic Host Configuration Protocol) can automatically assign a dynamic IP address to a LAN device. This is typically the easiest way to configure the instrument for LAN.

- This setting is non-volatile; it will not be changed by power cycling or *RST or SYSTEM:PRESet.
1. Press **Utilities** > **I/O Config** > **LAN Settings** > **DHCP On** to use DHCP to automatically assign an IP address.
 2. Press **Back**. You will be prompted by the below message.

Press 'Yes' to save LAN setting and 'No' to exit without saving.

Yes No

3. Press **Yes** to save the setting.
4. Press **No** to cancel all the changes and exit without saving.

To manually set an IP address, Subnet Mask, or Default Gateway, press **DHCP Off**. Then, change the IP setup as described below.

IP Address

You can enter a static IP address for the instrument as a four-byte integer expressed in dot notation. Each byte is a decimal value, with no leading zeros (for example, 192.168.2.20).

- If DHCP is on, it attempts to assign an IP address to the instrument. If it fails, Auto-IP attempts to assign an IP address to the instrument.
 - Contact your LAN administrator for details.
 - This setting is non-volatile; it will not be changed by power cycling or *RST or SYSTem:PRESet.
1. Press **Utilities** > **I/O Config** > **LAN Settings** > **DHCP Off**.
 2. Select IP Address field using the navigation keys. Set the desired IP address and press **Back**.
 3. Press **Yes** to save the setting.
 4. Press **No** to cancel all the changes and exit without saving.

Subnet Mask

Subnetting allows the LAN administrator to subdivide a network to simplify administration and minimize network traffic. The subnet mask indicates the portion of the host address used to indicate the subnet.

- Contact your LAN administrator for details.
 - This setting is non-volatile; it will not be changed by power cycling or *RST or SYSTem:PRESet.
1. Press **Utilities** > **I/O Config** > **LAN Settings** > **DHCP Off**.
 2. Select Subnet Mask field using the navigation keys. Set the desired subnet mask address and press **Back**.
(Example: 255.255.0.0)
 3. Press **Yes** to save the setting.
 4. Press **No** to cancel all the changes and exit without saving.

Gateway

A gateway is a network device that connects networks. The default gateway setting is the IP address of such a device.

- You need not set a gateway address if using DHCP.
 - Contact your LAN administrator for details.
 - This setting is non-volatile; it will not be changed by power cycling or *RST or SYSTem:PRESet.
1. Press **Utilities** > **I/O Config** > **LAN Settings** > **DHCP Off**.
 2. Select Gateway field using the navigation keys. Set the appropriate gateway address and press **Back**.
 3. Press **Yes** to save the setting.
 4. Press **No** to cancel all the changes and exit without saving.

DNS

DNS (Domain Name Service) is an Internet service that translates domain names into IP addresses. The DNS server address is the IP address of a server that performs this service.

- Normally, DHCP discovers DNS address information; you only need to change this if DHCP is unused or not functional. Contact your LAN administrator for details.
 - This setting is non-volatile; it will not be changed by power cycling or *RST or SYSTem:PRESet.
1. Press **Utilities** > **I/O Config** > **LAN Settings** > **AutoDNS On** to configure the addressing of the instrument in DNS server automatically.
 2. Press **Utilities** > **I/O Config** > **LAN Settings** > **AutoDNS Off** to configure the addressing of the instrument manually.
 3. Select DNS(1) Addr and DNS(2) Addr using the navigation keys. These fields only appear when AutoDNS is set to Off.
 4. Set the desired primary and secondary address and press **Back**.
 5. Select mDNS Service field using the navigation keys.
 6. Press **Yes** to save the setting.
 7. Press **No** to cancel all the changes and exit without saving.

DNS Hostname

A hostname is the host portion of the domain name, which is translated into an IP address.

Each load is shipped with a default hostname with the format: Keysight-modelnumber-serialnumber, where modelnumber is the electronic load's 8-character model number (e.g. EL34243A), and serialnumber is the last five characters of the 10-character load serial number located on the label on the top of the unit (e.g. 45678 if the serial number is MY12345678).

- The instrument receives a unique hostname at the factory, but you may change it. The hostname must be unique on the LAN.
 - The name must start with letter; other characters can be an upper- or lower-case letters, numeric digits, or dashes ("-").
 - This setting is non-volatile; it will not be changed by power cycling or *RST or SYSTem:PRESet.
1. Press **Utilities** > **I/O Config** > **LAN Settings**.
 2. Select DNS Hostname field using the navigation keys. Press  and enter the hostname with the keyboard provided. Press **Back**.
 3. Press **Yes** to save the setting.
 4. Press **No** to cancel all the changes and exit without saving.

mDNS Service

The mDNS service name is registered with the selected naming service.

Each electronic load is shipped with a default service name with the format: Keysight-modelnumberserialnumber, where modelnumber is the load's 8-character model number (e.g. EL34243A), and serialnumber is the last five characters of the 10-character electronic load serial number located on the label on the top of the unit (e.g. 45678 if the serial number is MY12345678).

- The instrument receives a unique mDNS service name at the factory, but you may change it. The mDNS service name must be unique on the LAN.
 - The name must start with letter; other characters can be an upper- or lower-case letters, numeric digits, or dashes ("-").
1. Press **Utilities** > **I/O Config** > **LAN Settings** > **mDNS Off** to configures the service name registered with the selected naming service automatically.
 2. Press **Utilities** > **I/O Config** > **LAN Settings** > **mDNS On** to configure the service name of the instrument manually.
 3. Select mDNS Service field using the navigation keys.
 4. Press **mDNS Srv** and enter the service name with the keyboard provided.
 5. Press **Back** to exit.

Using sockets

NOTE

Electronic loads allow any combination of up to two simultaneous data socket, control socket, and telnet connections to be made.

Keysight instruments have standardized on using port 5025 for SCPI socket services. A data socket on this port can be used to send and receive ASCII/SCPI commands, queries, and query responses. All commands must be terminated with a newline for the message to be parsed. All query responses will also be terminated with a newline.

The socket programming interface also allows a control socket connection. The control socket can be used by a client to send device clear and to receive service requests. Unlike the data socket, which uses a fixed port number, the port number for a control socket varies and must be obtained by sending the following SCPI query to the data socket: `SYSTem:COMMunicate:TCPip:CONTRol?`

After the port number is obtained, a control socket connection can be opened. As with the data socket, all commands to the control socket must be terminated with a newline, and all query responses returned on the control socket will be terminated with a newline.

To send a device clear, send the string "DCL" to the control socket. When the power system has finished performing the device clear it echoes the string "DCL" back to the control socket.

Service requests are enabled for control sockets using the Service Request Enable register. Once service requests have been enabled, the client program listens on the control connection. When the SRQ value is true, the instrument will send the string "SRQ +nn" to the client. The "nn" is the status byte value, which the client can use to determine the source of the service request.

More about IP addresses and dot notation

Dot-notation addresses ("nnn.nnn.nnn.nnn" where "nnn" is a byte value from 0 to 255) must be expressed with care, as most PC web software interprets byte values with leading zeros as octal (base 8) numbers. For example, "192.168.020.011" is equivalent to decimal "192.168.16.9" because ".020" is 16 expressed in octal, and ".011" (octal) is "9" (base 10). To avoid confusion, use only decimal values from 0 to 255, with no leading zeros.

Remote Control

You can control the instrument via SCPI with Keysight IO Libraries or via a simulated front panel with the instrument's Web interface.

Web interface

You can monitor and control the instrument from a Web browser by using the instrument's Web interface. To connect, simply enter the instrument's IP address or hostname in your browser's address bar and press Enter.

NOTE

If you see an error indicating 400: Bad Request, that is related to an issue with "cookies" in your Web browser. To avoid this issue, either start the Web interface by using the IP address (not hostname) in the address bar), or clear cookies from your browser immediately before starting the Web interface.

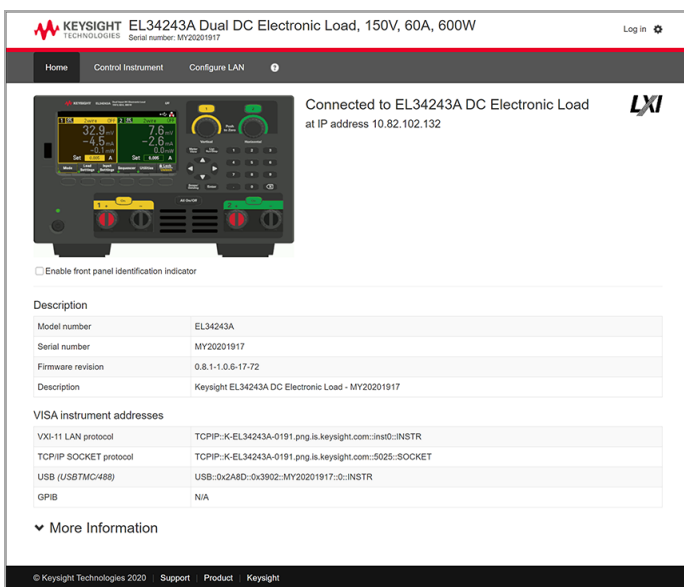

KEYSIGHT TECHNOLOGIES EL34243A Dual DC Electronic Load, 150V, 60A, 600W
Serial number: MY20201917

Home Control Instrument Configure LAN Log in

Connected to EL34243A DC Electronic Load at IP address 10.82.102.132

Enable front panel identification indicator

Description	
Model number	EL34243A
Serial number	MY20201917
Firmware revision	0.8.1-1.0.6-17-72
Description	Keysight EL34243A DC Electronic Load - MY20201917

VISA instrument addresses	
VXI-11 LAN protocol	TCPIP-K-EL34243A-0191.png.is.keysight.com::INSTR
TCP/IP SOCKET protocol	TCPIP-K-EL34243A-0191.png.is.keysight.com::5025-SOCKET
USB (USBTC488)	USB::0x2A8D::0x3902::MY20201917::0::INSTR
GPIB	N/A

More Information

© Keysight Technologies 2020 Support Product Keysight

Check the checkbox below the picture of the instrument to enable an indicator on the instrument's front panel. This is helpful if you have several EL30000 Series instruments and you wish to identify the one to which you are connected.

The Configure LAN tab on the top allows you to change the instrument's LAN parameters; exercise caution when doing so, as you may interrupt your ability to communicate with the instrument.

When you click the Control Instrument tab, the instrument will ask you for a password (default is *keysight*), and then it will open a new page, shown below.



This interface allows you to use the instrument just as you would from the front panel. Note the curved arrow keys that allow you to "rotate" the knob. You can press the arrow keys to rotate the knob clockwise and counter-clockwise, just as you would press any of the other keys on the front panel.

NOTE

READ WARNING

Be sure to read and understand the warning at the top of the Control Instrument page.

Technical connection details

In most cases, you can easily connect to the instrument with the IO Libraries Suite or Web interface. In certain circumstances, it may be helpful to know the following information.

Interface	Details
VXI-11 LAN	VISA String: TCPIP0:<IP Address>::inst0::INSTR Example: TCPIP0::192.168.10.2::inst0::INSTR
Web UI	Port number 80, URL http://<IP address>/
USB	USB0::0x2A8D::<Prod ID>::<Serial Number>::0::INSTR Example: USB0::0x2A8D::0x0902::MY55160003::0::INSTR The vendor ID: 0x2A8D, the product ID is 0x0902, and the instrument serial number is MY55160003. The product ID varies by model: 0x3702 (EL33133A), 0x3802 (EL34143A), and 0x3902 (EL34243A).

Use the Built-in Help System

The built-in help system provides context-sensitive help on any front panel key or menu softkey. A list of help topics is also available to help you learn about the instrument.

View the help information for the front panel key

NOTE

Note that there is no help information available for [Meter View] and Lock|Unlock keys.

Press and hold any softkey or key, such as [All On/Off]. If the message contains more information than will fit on the display, press the down arrow softkey to scroll down.

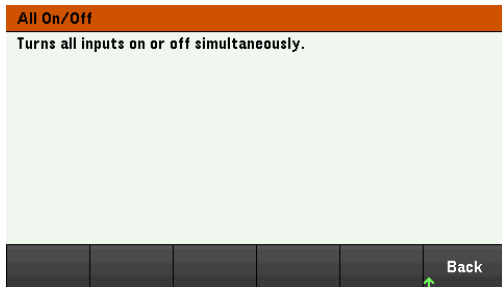

Press **Back** to exit.

View the list of help topics

Press **Utilities > Test / Setup > Help** to view the list of help topics. Press the arrow softkeys or use the front panel arrow keys to highlight the desired topic. Then press **Select**.

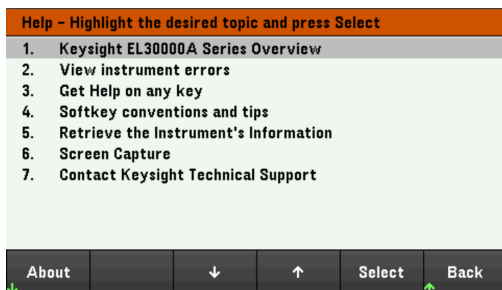

In this case, the following help topic appears:

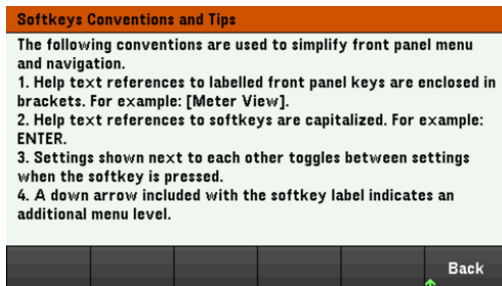

View the instrument model and serial number

Press **About** to view the instrument's model number, description and serial number.

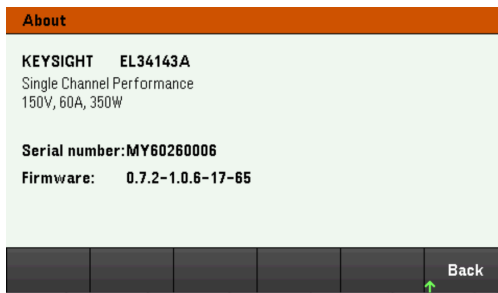

Press **Back** to exit.

NOTE

LOCAL LANGUAGE HELP

All front-panel keys' help, and help topics are available in English, French, German, Japanese, Korean, Chinese and Russian. To select the local language, press **Utilities > Test / Setup > User Settings > Display Options > Help Lang..** Then select the desired language. The menu softkey labels and status line messages are not translated.

Firmware Update

NOTE

Do not turn off the instrument during the update.

1. Press **Utilities** > **Test / Setup** > **Help** > **About** to determine what instrument firmware version is currently installed.
2. Go to www.keysight.com/find/el30000 to find the latest firmware version. If this matches the version installed on your instrument, there is no need to continue with this procedure. Otherwise, download the firmware update utility and a ZIP file of the firmware. Detailed firmware update instructions are located on the download page.

Front Panel Menu Reference

This is an overview of the front-panel menus. Press the softkeys to access the front panel menus.

Menu heading	Description
Mode>	
CC	Constant current (CC) mode. In this mode, the load will sink a current in accordance with the programmed value regardless of the input voltage.
CV	Constant voltage (CV) mode. In this mode, the load will attempt to sink enough current to maintain the input voltage at its programmed value.
CR	Constant resistance (CR) mode. In this mode, the load will sink current proportional to the input voltage in accordance with the programmed resistance.
CP	Constant power (CP) mode. In this mode, the load will regulate the power being drawn from the DUT according to the programmed constant-power value.
Load Settings >	
Mode >	Configures the operating mode to CC, CV, CR, or CP.
Sense	Configures the load input sense to 2-wire or 4-wire.
Protection >	Configures the protection setting for the load input.
Range >	Configures the measurement range for load input.
Short	Enable or disable the input short.
Input Settings>	
On/Off Coupling >	Enables or disables the input coupling or synchronization between multiple input channels.
Output Inhibit >	Configures the inhibit input mode and Digital IO Pin 3.
Operation Mode >	Configures the input capability when two independent inputs are being used. (EL34243A only)
Sequencer >	
Sequencer >	Configures the sequencer type: LIST, Continuous, Pulse, and Toggle.
Utilities >	
Store / Recall >	Saves and recalls instrument states.
I/O Config >	Displays and configures the I/O parameters for remote operations over the USB, LAN, GPIB, or digital IO interface.
Test/Setup >	Accesses the self-test, calibration, and help function as well as configures the user preferences, and sets date and time.
Error >	Displays the instrument's error queue. Errors will be cleared after viewing or instrument reset.
Manage Files >	Creates, copies, deletes, and renames files and folders on the USB drive attached to the front panel. Also allows you to capture the current screen to either a bitmap (*.bmp) or portable network graphics (*.png) file.
Lock Unlock	Locks and unlocks the display.

2 General Operating Information

- Turning the Unit On
- Controlling the Inputs
- Using the Protection Function
- Specifying 2-Wire or 4-Wire Sense
- Configuring the Input Turn On Turn Off Sequence
- Specifying the Load Operating Mode
- Configuring the Load Settings
- Configuring the Operation Mode
- Using the Digital Control Port
- Using the Sequencer Function
- Using the Data Logger Function
- Using the Scope Function
- Locking/Unlocking the Front Panel
- Capturing a Screen
- Utilities Menu

This chapter describes the general operating information of the EL30000 Series.

NOTE

For the characteristics and specifications of the EL30000 Series DC electronic loads, refer to the datasheet at <https://www.keysight.com/my/en/assets/3120-1430/data-sheets/EL30000-Series.pdf>.

Turning the Unit On

After you have connected the power cord, press the **[Power]** key to turn the unit on. The front panel display lights up after a few seconds. When the front panel meter view appears, use the knob or the numeric entry keys to enter the input values.

EL33133A/EL34143A

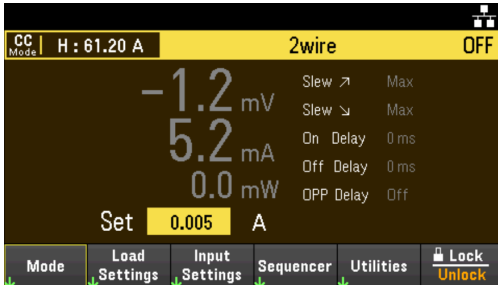

For EL34243A, Input 1 is selected by default:

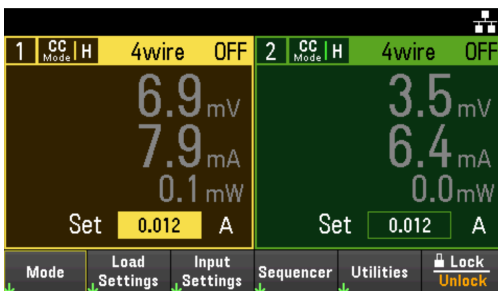

EL33133A/EL34143A: Press the **[On]** key to enable the input.

EL34243A: Press one of the two **[On]** keys to enable an individual input or press the **[All On/Off]** key to enable both inputs simultaneously.

NOTE

A power-on self-test occurs automatically when you turn the unit on. This assures you that the instrument is operational. If self-test fails, or if other operating problems occur with your instrument, the front panel error indicator (**!Err**) appears at the upper top of the display.

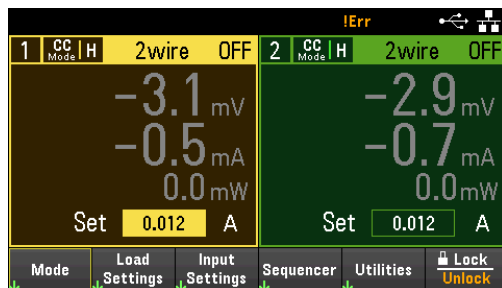

Using the front panel knobs

There are two knobs on the front panel: Vertical and Horizontal.

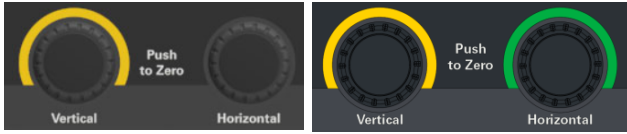

EL33133A/EL34143A

EL34243A

These knobs are active in Meter View, Scope View, Data Logger View, as well as in Settings page.

- In Meter View, these knobs are channel-specific. Adjusting the Vertical knob will adjust the values for Channel 1, while Horizontal knob for Channel 2. Turn the knob to set the input and push the knob to zero the value in a specified field.
- In Scope and Data Logger view, these knobs can be programmed according to the different operating function for value adjustment.
 - For more information on the knob usage in data logger view, see [Using knob in data logger view](#).
 - For more information on the knob usage in scope view, see [Using knob in scope view](#).
- In Settings page (except in Scope and Data Logger view), these knobs are channel-specific and can be used to change values or toggle between parameter. Adjusting the Vertical knob will adjust the values for Channel 1, while Horizontal knob for Channel 2.

View the error log

Press **Utilities** > **Error** to display the error log. If there are more than 10 errors on the display, press **Next** to scroll to the next page.



Press **Back** or **[Meter View]** to return to the meter-view display.

- Errors are stored in the order they are received. The error at the end of the list is the most recent error.
- If there are more than 20 errors in the queue, the last error stored is replaced with -350, "Queue overflow". No more errors are stored until you remove errors from the queue. If there are no errors, the instrument responds with +0, "No error".
- Except for self-test errors, errors are cleared when exiting the Error Log menu or when cycling power.

If you suspect that there is a problem with the electronic load, refer to the "Troubleshooting" section in the *Service Guide*.

Controlling the Inputs

Step 1 - Select an input (EL34243A only)

Press one of the input selection keys to select an input to control. The lit key identifies the selected input. All subsequent input-specific front panel commands are sent to the selected input.



Step 2 - Set the load operating mode

Press **Mode** to set the operating mode to constant current (CC), constant voltage (CV), constant resistance (CR), or constant power (CP) mode.

Refer to the **Load Operating Modes** for more information.

Step 3 - Set the input voltage, current, resistance, or power

Turn the knob to set the input. The input values changes when they are turned.

This knob is active in Meter View, Scope View and Data Logger View.

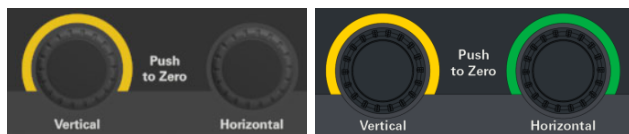

EL33133A/EL34143A

EL34243A

You can also enter the voltage, current, resistance, or power values directly in the numeric entry fields (the Set fields) in the meter-view display. Use the navigation keys to select the field; use the numeric entry keys to enter the value.

The value becomes active when you press **[Enter]**.

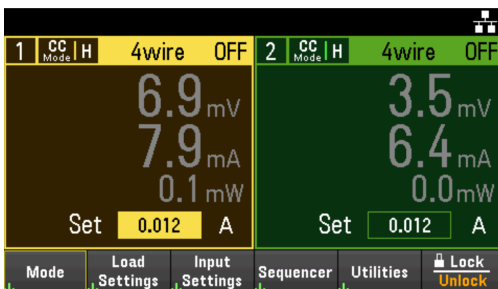

Lastly, you can press the **Load Settings** key to access the Load Settings window. Use the navigation keys to highlight the voltage, current, resistance, or power fields. Then enter the input values with the numeric keys. You can also use the knob to adjust the values in the value fields for Channel 1/Channel 2 input accordingly.

Press **[Enter]** to enter the value. Press **Back** to return to the meter-view display.

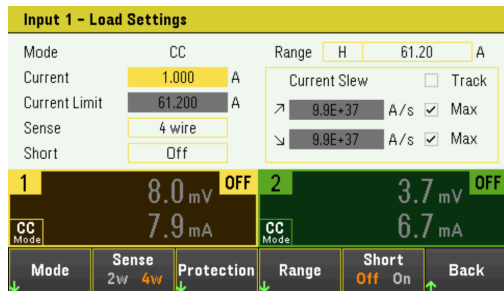

Refer to **Programming Ranges** for the load input range and its default value.

Step 4 - Enable the input

Press the color-coded **[On]** key to enable an individual load input. When an input is on, the **[On]** key for that input is lit. When an input is off, the **[On]** key is not lit.

EL34243A only: The **[All On/Off]** key turns all inputs on or off simultaneously.

The state of a disabled input (input off) is a condition of zero input voltage and zero source current.

Step 5 - View the input voltage and current

Press **[Meter View]** to view the input voltage and current. When an input is enabled, the front panel meters continuously measure and display the voltage and current either input or sense terminal.

No matter which operating mode you are operating in, the front panel meter view returns the voltage and current measurement from either input or sense terminal. Power measurements are displayed along with voltage and current in single-channel view.

The following meter view applies to CC mode. CV, CP, and CR mode views are similar. All measurements have an over-range capability of 10% above the maximum range limit. If the measurement exceeds this limit, “Data Out of Range” error will occur

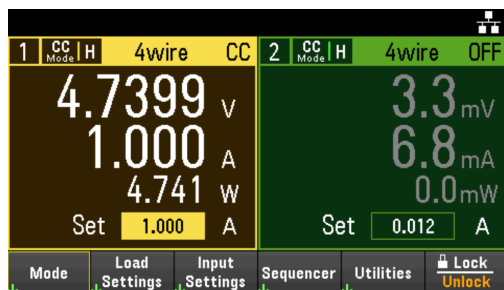

From the remote interface:

A channel parameter is required with each SCPI command to select an input. For example, (@1) selects input 1 and (@1,2) selects input 1 and 2. The input list must be preceded with an @ symbol and be enclosed in parentheses ().

To set input 1 load operating mode to CC:

FUNC CURR, (@1)

To set only input 1 to 1 A:

CURR 1, (@1)

To enable only input 1:

INP ON, (@1)

To enable input 1 and input 2:

INP ON, (@1,2)

To measure the average input voltage, current, and power of input 1:

MEAS:VOLT? (@1)

MEAS:CURR? (@1)

MEAS:POW? (@1)

Using the Protection Function

Protection function

Each input has independent protection functions. A front panel status indicator will turn on when a protection function is set. Protection functions are latching, which means that they must be cleared once they are set.

Of the following protection functions, only OC, LIM+ and UVI are user-programmable.

- **OV**: Over-voltage protection is a hardware OVP whose trip level is non-programmable and is fixed at 110% of the rated input voltage. OVP is enabled by default.
- **OV-**: Negative voltage protection is a hardware OVP.
- **OC**: Over-current protection is a programmable function that can be enabled or disabled. When enabled, the input will be disabled when the input current reaches the current limit setting.
- **OT**: Over-temperature protection monitors the temperature of each input and shuts down the input if any temperature exceeds the maximum factory-defined limits.
- **CP+**: CP+ indicates that a positive power limit condition has disabled the input. Refer to **Over-Power Protection** for further information.
- **INH**: The Inhibit input (pin 3) on the rear panel digital connector can be programmed to act as an external shut-down signal. Refer to **Inhibit Input** for further information.
- **LIM+**: In CV, CP and CV mode, LIM+ indicates the input is in positive current limit. In CC mode, LIM+ indicates the input is in positive voltage limit.
- **UVI**: Under-voltage inhibit (UVI) protection. UVI is disabled by default. Refer to **Under Voltage Inhibit** for further information.

Configuring protection

Protection functions are configured on the Load Settings window.

Press **Load Settings** to access the Load Settings window. Next, press **Protection** to access the protection functions.

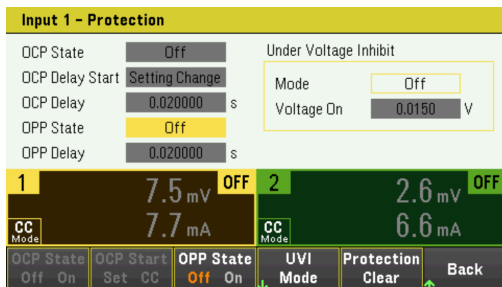

OC Protection

With over-current protection enabled, the load disables the input if the input current reaches the current limit setting, which causes a transition from CV to CC mode.

Press **OCP State On** to enable over-current protection.

Press **OCP State Off** to disable over-current protection.

NOTE

The EL30000 Series has fixed over-current protection that is always enabled. This protection will turn the input off whenever the input current exceeds 105% of the high ranges and approximately 110% of the low current ranges.

You can also specify a delay to prevent momentary CV-to-CC status changes from tripping the OCP. The delay can be programmed from 0 to 0.255 seconds. You can specify if the start of the delay is initiated by any transition into CC mode, or only at the end of a settings change in voltage, current or input state.

OCP Delay

The load may momentarily cross into CC mode when it is turned on, when an input value is programmed, or when the DUT is connected. In most cases these temporary conditions would not be considered an over-current protection fault, and having an OCP condition disables the input when the CC status bit is set would be a nuisance. Specifying an OCP delay will ignore the CC status bit during the specified delay period.

To set the over-current protection delay, enter the delay value in the OCP Delay field. The delay can be programmed from 0 to 0.255 seconds.

OCP Delay Start

Specifying an OCP Delay Start lets the OCP circuit ignore the CC status bit during the specified delay period. Once the OCP delay time has expired and if the CC mode persists, the input will shut down.

You can specify the OCP delay start timer through:

- CC Transition: Delay timer starts at any transition of the input into CC mode. Press **OCP Start CC**.
- Setting Change: Delay timer starts at the end of a settings change in voltage, current, or input state. Press **OCP Start Set**.

OP Protection

With over-power protection enabled, the electronic load disables the input if the input power exceeds 110% of the load's power rating.

Press **OPP State On** to enable over-power protection.

Press **OPP State Off** to disable over-power protection.

OPP Delay

Specifying an OPP delay prevent the over-power protection function from being triggered during the delay time. This prevents momentary input power spikes from triggering the over-power protection. A status bit (CP+) indicates that the input has been turned off by a power limit condition.

To set the over-power protection delay, enter the delay value in the OPP Delay field. The delay can be programmed from 0 to 0.255 seconds.

Under Voltage Inhibit

When the under-voltage inhibit function is enabled by selecting a mode, the load will not sink current until the input voltage rises above the voltage-on setting.

Press **UVI Mode** to specify the under-voltage inhibit mode:

- **Off**: Turns the under-voltage inhibit function off.
- **Live**: Turns the input off whenever the voltage drops below the voltage-on setting. Turns the input back on when the voltage reaches the voltage-on setting.
- **Latched**: Lets the load sink current when the voltage subsequently drops below the voltage-on setting. An under-voltage inhibit condition is annunciated by the UVI status bit.

NOTE

Under-voltage inhibit is not available when loads are grouped or when the unit is operating in CV mode.

To set the voltage-on setting, enter the voltage-on value in the Voltage On field. The voltage-on value can be programmed from 0 to 153 V.

Clears OVP, OCP and OPP Event

To clear the protection function, first remove that condition that caused the protection fault.

Press **Protection Clear** to clear the protection function and returns the input to its previous operating state.

From the remote interface:

To enable the over-current protection for input 1 and 2:

```
CURR:PROT:STAT ON, (@1,2)
```

To set the over-current protection delay time for input 1 at 0.1 seconds:

```
CURR:PROT:DEL 0.1, (@1)
```

To set the over-current protection delay timer start for input 1 to CC transition:

```
CURR:PROT:DEL:STAR CCTR, (@1)
```

To enable the over-power protection for input 1 and 2:

```
POW:PROT:STAT ON, (@1,2)
```

To set the over-power protection delay time for input 1 at 0.2 seconds:

```
POW:PROT:DEL 0.2, (@1)
```

To program a low-voltage limit (under-voltage inhibit) of 2 V, and enable the inhibit mode:

```
VOLT:INH:VON 2, (@1)
```

```
VOLT:INH:VON:MODE LIVE, (@1)
```

To clear protection for input 1:

```
INP:PROT:CLE (@1)
```

Specifying 2-Wire or 4-Wire Sense

For EL33133A and EL34143A, you have the option to use the remote sense terminal on the front or rear panel to measure the voltage from the device under test (DUT).

For EL34243A, you can only use the remote sense terminal located on the rear panel.

1. Press **Load Settings**.
2. Press **Sense 2w** or **Sense 4w** to select 2-wire sense or 4-wire sense.
3. Press **Back** to exit and return to the meter-view display.

The 2w mode closes a relay within the load to short the input and sense connectors. This means that only two wires are used, and 4-wire sense is disabled. The 4w mode opens the relay in order to separate the input and 4-wire sense inputs. By default, 2w is selected.

From the remote interface:

To set the remote sense relay to 4-wire sense at input 1:

```
VOLT:SENS EXT, (@1)
```

Configuring the Input Turn-On/Turn-Off Sequence

Turn-on and turn-off delays control the turn-on and turn-off timing of the inputs in relation to each other.

Step 1 – Set the input voltage, current, power or resistance of the input channels:

Refer to steps 1 and 2 under **Controlling the Inputs** and set the input values of all inputs that will be sequenced.

Step 2 – Configure the turn-on turn-off delays:

Press **Input Settings** to access the Input Settings – On/Off Delays. Enter the On Delays and Off Delays for all inputs that will participate in the input on/off delay sequence. Values can range from 0 to 1023 seconds.

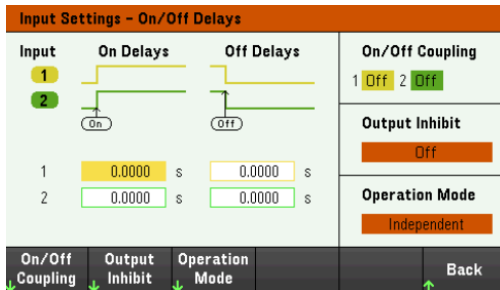

Step 3 – Coupling selected inputs:

NOTE

This step is only required if you will be including some inputs to participate in an input on/off delay sequence or if you are coupling multiple electronic loads. If only a single input is to be used in the sequence, you can skip this step.

From the menu, press **On/Off Coupling** to access the On/Off Coupling mode settings.

- Press **Coup CH 1** to toggle between Off and On in order to turn off or on the coupling for Input 1.
- Press **Coup CH 2** to toggle between Off and On in order to turn off or on the coupling for Input 2. (applicable for EL34243A only)

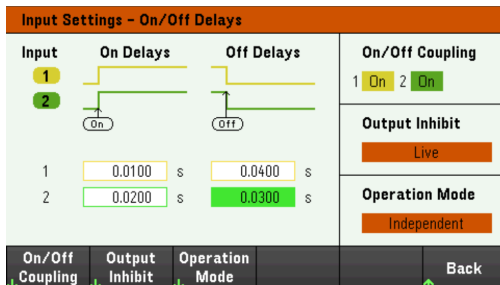

Step 4 – Use the All Inputs On and Off keys:

Once input delays have been set, press **[All On/Off]** to start the On delay and Off delay sequence.

NOTE

[All On/Off] will turn ALL inputs on or off, whether they are configured to participate in an input on/off delay sequence or not.

From the remote interface:

To program turn-on and turn-off delays for inputs 1 and 2:

```
INP:DEL:RISE 0.01, (@1)
```

```
INP:DEL:RISE 0.02, (@2)
```

```
INP:DEL:FALL 0.04, (@1)
```

```
INP:DEL:FALL 0.03, (@2)
```

To only include inputs 1 and 2 in a sequence:

```
INP:COUP:CHAN CH1,CH2
```

To turn on two coupled inputs in a sequence:

```
INP ON (@1:2)
```

Specifying the Load Operating Mode

The operating modes of operation for Keysight EL30000 Series electronic load are:

- **Constant current (CC):** In this mode, the electronic load will sink a current in accordance with the programmed value regardless of the input voltage. Note that a programmable voltage limit is not available. If the DUT imposes a voltage above the voltage rating of the module, the overvoltage protection will trip.
- **Constant voltage (CV):** In this mode, the electronic load will sink enough current to control the DUT voltage to the programmed value. The load acts as a shunt voltage regulator when operating in voltage priority mode.
- **Constant resistance (CR):** In this mode, the electronic load will sink a current linearly proportional to the voltage in accordance with the programmed resistance value.
- **Constant power (CP):** In this mode, the electronic load will maintain the input power at the specified programmed power level.

When programmed to a mode, the electronic load remains in that mode until the mode is changed or until a fault condition, such as an overpower or overtemperature, occurs.

Refer to the [Load Operating Modes](#) for more information.

1. Press **Mode** or press **Load Settings** > **Mode**.
2. Press **CC**, **CV**, **CR**, or **CP** to select the desired operation mode.



3. Press **Back** to exit.

Alternatively, you may also set the operating mode under **Load Settings** > **Mode**.

From the remote interface:

To specify the load operating mode:

FUNC VOLT, (@1)
FUNC CURR, (@1)
FUNC RES, (@1)
FUNC POW, (@1)

Configuring the Load Settings

Press **Load Settings** to access the available configuration for the EL30000 Series.

Operating modes

Press **Mode** to select one of the four operating modes (CC, CV, CR and CP). The parameters in Load Settings page will change accordingly to the selected operating mode.

NOTE

When switching between operating modes, the load input is turned off and the Load Settings revert to their Power-on or RST values.

Constant current mode

In this mode, the load will sink a current in accordance with the programmed value regardless of the input voltage. Note that a programmable voltage limit is not available. If the DUT imposes a voltage above the voltage rating of the load, the overvoltage protection will trip.

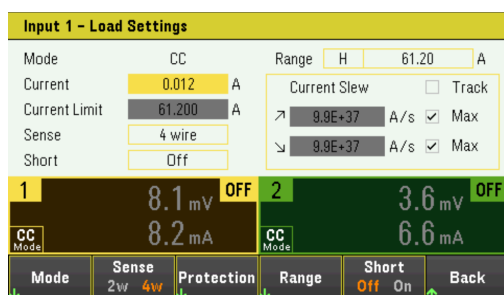

Current - Lets you enter a current value with the numeric keys. Press Enter to enter the value. You can use the knob to adjust the value in this field.

Range - Lets you select from three current ranges using the **Range** softkey. The low range provides better resolution at low current settings. Alternatively, you can use the knob or press **Enter** to toggle between the ranges in this field. See [Programming Ranges](#).

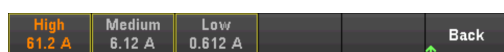

Sense - The default sense setting is Local (2W), where the sense terminals are connected directly to the input terminals. If you are using remote voltage sensing as explained under 4-Wire Sense, you must disconnect the sense terminals from the input terminals. Toggling to **4W** using the **Sense** softkey disconnects the sense terminals from the input terminals. This lets you use remote voltage sensing. Alternatively, you can use the knob or press **Enter** to toggle between the sense setting in this field.

Short - Lets you short the input terminals. This simulates a short circuit on the input of the load. It works in all operating modes and temporarily overrides input and slew settings. Note that the input on/off and the input protection functions take precedence over an input short. An input-short condition is announced by the SH status bit. Press **Enter** to enable or disable short in this field.

Current Slew - Specifies the maximum or fastest allowable slew rate (positive or negative) when checked. Unchecking these boxes lets you enter a slower slew rate in the appropriate fields. Separate slew settings can be programmed for CC, CV, CR, and CP modes.

Track - Lets the negative slew rate track the positive slew rate when checked. Uncheck this box if you want to program asymmetrical positive and negative slew rates. If asymmetrical rates are programmed and tracking is turned on, the negative value is changed to track the positive value.

Constant voltage mode

In this mode, the load will sink enough current to control the DUT voltage to the programmed value. The load acts as a shunt voltage regulator when operating in CV mode.

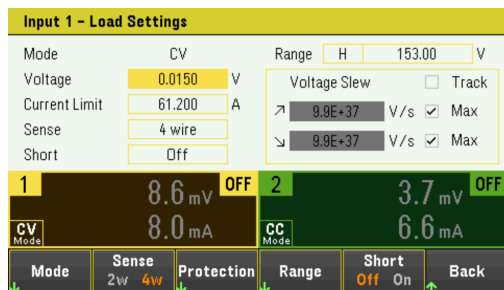

Voltage - Lets you enter a voltage value with the numeric keys. Press Enter to enter the value. You can also use the knob to adjust the value in this field.

Range - Lets you select from two voltage ranges. The low range provides better resolution at low voltage settings. Alternatively, you can use the knob or press **Enter** to toggle between the ranges in this field. See **Programming Ranges**.



Current Limit - You can specify a current limit that limits the input current when in CV mode. It is programmable up to the rated current, with an over-range of 2%.

Refer to **Constant current mode** for descriptions of the Slew rate, Enable short, Track and Sense controls.

Constant resistance mode

In this mode, the load will sink a current linearly proportional to the voltage in accordance with the programmed resistance value.

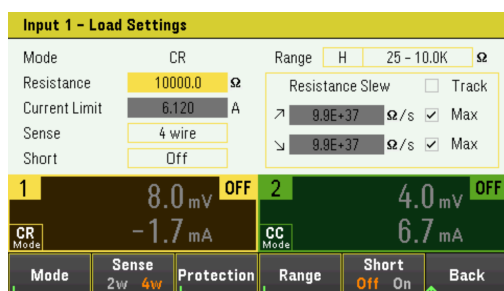

Resistance - Lets you enter a resistance value with the numeric keys. Press Enter to enter the value. You can also use the knob to adjust the value in this field.

Range - Lets you select from four overlapping resistance ranges. The lower ranges provide better resolution at low resistance settings. Alternatively, you can use the knob or press **Enter** to toggle between the ranges in this field. See [Programming Ranges](#).



Current Limit - The current limit is fixed at the specified setting.

NOTE

When changing ranges, the load input will be turned off, then back on again.

Refer to [Constant current mode](#) for descriptions of the Slew rate, Enable short, Track and Sense controls.

Constant power mode

In this mode, the load will maintain the input power at the specified programmed power level. Note that the load has an independent power limit loop that regulates the input power at the limit setting - either 250 W (EL33133A), 350 W (EL34143A), or 300 W (EL34243A), with an over-range of 10%.

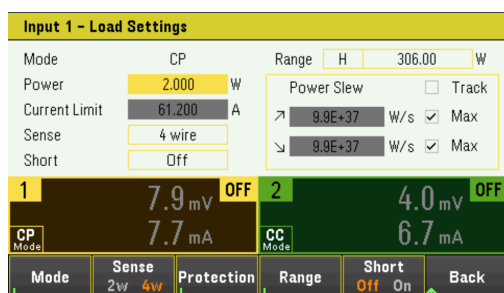

Power - Lets you enter a power value with the numeric keys. Press Enter to enter the value. You can also use the knob to adjust the value in this field.

Range - Sets the power range. Lets you select from three power ranges. The value that you enter must be the highest value in Watts that you expect to input. Alternatively, you can use the knob or press **Enter** to toggle between the ranges in this field. See [Programming Ranges](#).



Refer to [Constant current mode](#) for descriptions of the Slew rate, Enable short, Track and Sense controls.

From the remote interface:

To specify the load operating mode:

- FUNC VOLT, (@1)
- FUNC CURR, (@1)
- FUNC RES, (@1)
- FUNC POW, (@1)

To set the voltage to 10 V, the current to 5 A, the resistance to 100 Ω , and power to 50 W:

- VOLT 10, (@1)
- CURR 5, (@1)
- RES 100, (@1)
- POW 50, (@1)

Optionally, set a current limit value of 5 A while in CV mode:

```
CURR:LIM 5, (@1)
```

To select a lower current, power, or resistance range, program a value that falls within the range:

```
CURR:RANG 5, (@1)
```

```
RES:RANG 50, (@1)
```

```
POW:RANG 5, (@1)
```

To short the input terminals:

```
INP:SHOR ON, (@1:2)
```

To program a low-voltage limit (under-voltage inhibit) of 2 V, and enable the inhibit mode:

```
VOLT:INH:VON 2, (@1)
```

```
VOLT:INH:VON:MODE LIVE, (@1)
```

To set the current slew rate to 2 Amps/second:

```
CURR:SLEW 5, (@1)
```

To set the negative current slew, turn coupling (tracking) off. Then set the negative current slew:

```
CURR:SLEW:COUP OFF, (@1)
```

```
CURR:SLEW:NEG 3, (@1)
```

To set the sense terminals to remote sensing:

```
VOLT:SENS:SOUR EXT, (@1)
```

To query the setting of the sense terminals:

```
VOLT:SENS:SOUR? (@1)
```

Specifying the Operation Mode (EL34243A only)

The Operation Mode allows you to specify the input capability when two independent inputs are being used.

- **Independent:** This operation supply two independent inputs capability to a maximum rating of +150 V, +60 A. In Independent mode, the instrument is at its default input state.
- **Parallel:** This operation increases the current capability to a maximum rating of +150 V, +120 A. In Input-Parallel mode, the instrument doubles the input current on Input 1.

1. Press **Input Settings** > **Operation Mode**.
2. Press **Independent** or **Parallel** to select the desired operation mode.



3. Press **Back** to exit.

For input connection in Input-Parallel mode, see [Parallel Connections](#) for details.

From the remote interface:

To enable Input-parallel mode:

INP:PAIR PAR

Using the Digital Control Port

Bi-directional digital IO

Digital input

Fault output

Inhibit input

Fault/inhibit system protection

Trigger input

Trigger output

Input Couple Controls

NOTE

The wire connection to the digital port is not recommended to be longer than 3 meters.

A Digital Control Port consisting of three I/O pins is provided to access various control functions. Each pin is user-configurable. The following control functions are available for the I/O pins:

Bi-directional digital IO

Each of the three pins can be configured as general purpose bi-directional digital inputs and outputs. The polarity of the pins can also be configured. Pin 4 is the signal common for the digital I/O pins. Data is programmed according to the following bit assignments:

Pins	3	2	1
Bit Weight	2 (msb)	1	0 (lsb)

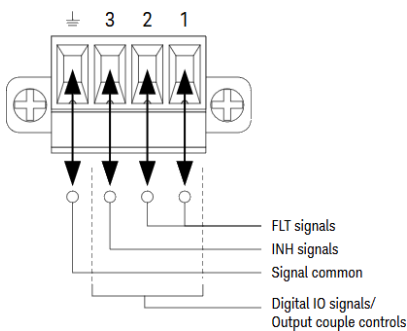

The digital I/O pin can be used to control both relay circuits as well as digital interface circuits. The figure above illustrates typical relay circuits as well as digital interface circuit connections using the digital I/O functions.

From the front panel:

1. Press **Utilities** > **I/O Config** > **Digital IO** to access the Digital I/O window.

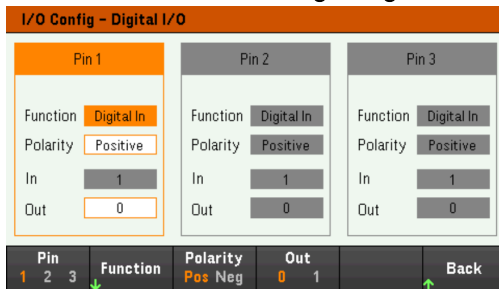

2. Select the pin you wish to configure. For example, press **Pin 1** to configure Pin 1.
3. Press **Function** and select **Digital I/O**. Select and program the remaining pins in the same manner. Press **Back** to return to previous page.
4. Configure the polarity for each of the pin. Press **Polarity Pos** to select Positive and **Polarity Neg** to select Negative. Select and program the remaining pins in the same manner.
5. The In and Out field only apply to the Digital I/O and Digital In functions. Press **Out** to toggle and enter the binary bit (0 or 1) into the Out field of the digital I/O window. For Digital I/O function, a binary bit 1 with positive polarity specify a voltage high at the pin while a binary bit 0 with positive polarity specify a voltage low at the pin. The In field reflects the condition of the external signal that is applied to the pins.

From the remote interface:

To configure the digital I/O function for pins 1 through 3:

```
DIG:PIN 1:FUNC DIO
DIG:PIN 2:FUNC DIO
DIG:PIN 3:FUNC DIO
```

To configure the pin polarity to positive for pins 1 through 3:

```
DIG:PIN 1:POL POS
DIG:PIN 2:POL POS
DIG:PIN 3:POL POS
```

To send a binary weighted value to configure pins 1 through 3 as "111":

```
DIG:OUTP:DATA 7
```

Digital input

Each of the three pins can be configured as digital input only. The ground reference for the input pins is Signal Common on pin 4.

From the front panel:

1. Press **Utilities** > **I/O Config** > **Digital IO** to access the Digital I/O window.
2. Select the pin you wish to configure. For example, press **Pin 1** to configure Pin 1.
3. Press **Function** and select **Digital In**. Select and program the remaining pins in the same manner. Press **Back** to return to previous page.
4. Configure the polarity for each of the pin. Press **Polarity Pos** to select Positive and **Polarity Neg** to select Negative. Select and program the remaining pins in the same manner.
5. The In and Out field only apply to the Digital I/O and Digital In functions. The In field reflects the condition of the external signal that is applied to the pins. The pin state is not affected by the value of the binary output word.

From the remote interface:

To configure the pin function:

```
DIG:PIN 1:FUNC DINP
```

To select the pin polarity:

```
DIG:PIN 1:POL POS
```

```
DIG:PIN 1:POL NEG
```

To read the pin data:

```
DIG:INP:DATA?
```

Fault output

Pins 1 and 2 can be configured as a fault output. The Fault Output function enables a fault condition on any channel to generate a protection fault signal on the digital port. The following conditions will generate a fault event: over-voltage, over-current, over-temperature and inhibit signal.

Both pins 1 and 2 are dedicated to this function. Pin 1 is the fault output; pin 2 is the common for pin 1. This provides for an optically-isolated output. The polarity of pin 1 can also be configured. Note that the fault output signal remains latched until the fault condition is removed and the protection circuit is cleared.

NOTE

Pin 2's selected function is ignored. Pin 2 should be connected to the ground of the external circuit.

From the front panel:

1. Press **Utilities** > **I/O Config** > **Digital IO** to access the Digital I/O window.
2. Press **Pin 1** to configure Pin 1.
3. Press **Function** and select **Fault Out**. Press **Back** to return to previous page.
4. Configure the polarity for each of the pin. Press **Polarity Pos** to select Positive and **Polarity Neg** to select Negative.

From the remote interface:

To configure the pin function:

```
DIG:PIN1:FUNC FAUL
```

To select the pin polarity:

```
DIG:PIN1:POL POS
```

```
DIG:PIN1:POL NEG
```

Inhibit input

Pin 3 can be configured as a remote inhibit input. The Inhibit Input function lets an external input signal control the load input state of all the input channels in the load. The polarity of pin 3 can also be configured. The load input is level triggered. The signal latency is less than 450 microseconds. Maximum time required for all the input channels to start to turn off is 45 ms. Pin 4 is the common for pin 3.

The following non-volatile inhibit input modes can be programmed:

LATChing - causes a logic-true transition on the Inhibit input to disable the load input. The load input will remain disabled after the inhibit signal is received.

LIVE - allows the enabled load input to follow the state of the Inhibit input. When the Inhibit input is true, the load input is disabled. When the Inhibit input is false, the load input is re-enabled.

OFF - The Inhibit input is ignored.

From the front panel:

Configure Pin 3 as a remote inhibit input:

1. Press **Utilities** > **I/O Config** > **Digital IO** to access the Digital I/O window.
2. Press **Pin 3** to configure Pin 3.
3. Press **Function** and select **Inhibit In** to configure Pin 3 as a remote inhibit input. Press **Back** to return to previous page.
4. Configure the polarity for Pin 3. Press **Polarity Pos** to select Positive and **Polarity Neg** to select Negative.

Alternatively, you can configure Pin 3 as a remote inhibit input by pressing **Input Settings** > **Output Inhibit** > **DIO Pin 3 INH**. In this setting, the polarity is set to Positive by default.

Configure the inhibit input mode:

1. Press the **Input Settings** > **Output Inhibit** to configure the inhibit input mode.
2. Select the desired mode (**Off**, **Latched** or **Live**).



To clear the Inhibit protection function, first remove the external Inhibit signal. Then select **Load Settings** > **Protection Clear** for all load inputs. This clears the Inhibit protection function and returns the load input to its previous operating state.

From the remote interface:

To select the Inhibit function:

DIG:PIN3:FUNC INH

To select the pin polarity:

DIG:PIN3:POL POS

DIG:PIN3:POL NEG

To set Inhibit mode to Latching:

OUTP:INH:MODE LATC

To set Inhibit mode to Live:

OUTP:INH:MODE LIVE

To disable the Inhibit signal:

OUTP:INH:MODE OFF

Fault/inhibit system protection

The following figure illustrates some ways that you can connect the Fault/Inhibit pins of the connector.

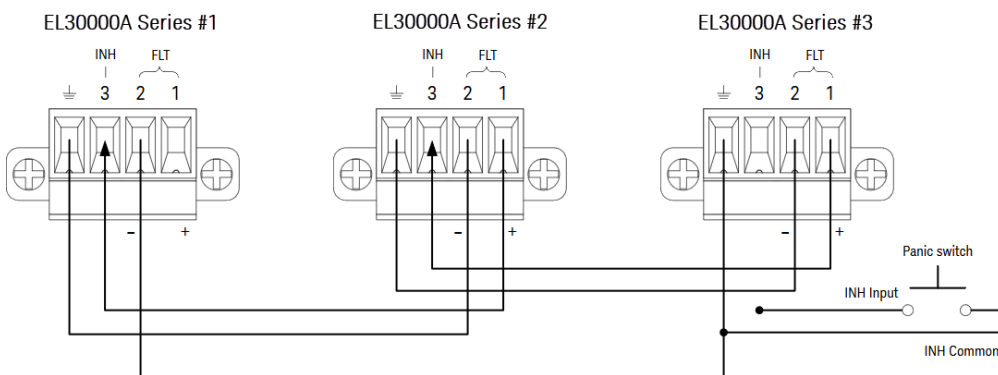

As shown in the figure, when the Fault outputs and Inhibit inputs of several instruments are daisy-chained, an internal fault condition in one of the units will disable all load inputs without intervention by either the controller or external circuitry. Note that when using the Fault/Inhibit signals in this manner, both signals must be set to the same polarity.

You can also connect the Inhibit input to a manual switch or external control signal that will short the Inhibit pin to common whenever it is necessary to disable all load inputs. **Negative** polarity must be programmed for all pins in this case. You can also use the Fault output to drive an external relay circuit or signal other devices whenever a user-definable fault occurs.

Clearing a System Protection Fault

To restore all instruments to a normal operating condition when a fault condition occurs in a daisy-chained system protection configuration, two fault conditions must be removed:

1. The initial protection fault or external Inhibit signal.
2. The subsequent daisy-chained fault signal (which is sourced by the Inhibit signal).

NOTE

Even when the initial fault condition or external signal is removed, the fault signal is still active and will continue to shut down the load inputs of all the units.

To clear the daisy-chained fault signal if the operating mode of the Inhibit input is Live, simply clear the input protection on any ONE unit by pressing **Load Settings > Protection Clear** for all load inputs.

If the operating mode of the Inhibit input is Latched, turn off the inhibit input and clear the input protection for all load inputs on ALL units individually. To re-enable the chain, re-program the Inhibit input on each unit to Latched mode.

Trigger input

Any of the Digital Control pins can be programmed to function as a trigger input. All pins are referenced to the signal common pin.

To input an external trigger signal, you can apply either a negative-going or a positive-going pulse to the designated trigger input pin. The trigger latency is less than 450 microseconds. The minimum pulse width is 2 microseconds. The pin's polarity setting determines which edge generates a trigger-in event. Positive means a rising edge and Negative means a falling edge.

You can configure the data logger and the Input LIST to be triggered by external trigger signals. Simply select DIO Trigger In as the trigger source when configuring the data logger and Input LIST. This will enable input trigger signals on the configured digital pins. A trigger is generated when an external signal that meets the signal criteria is applied to any configured trigger input pin.

From the front panel:

1. Press **Utilities > I/O Config > Digital IO** to access the Digital I/O window.
2. Select the pin you wish to configure. For example, press **Pin 1** to configure Pin 1.
3. Press **Function** and select **Trigger In**. Select and program the remaining pins in the same manner. Press **Back** to return to previous page.
4. Configure the polarity for each of the pin. Press **Polarity Pos** to select Positive and **Polarity Neg** to select Negative. Select and program the remaining pins in the same manner.

From the remote interface:

To select the trigger input function:

DIG:PIN1:FUNC TINP

To select the pin polarity:

DIG:PIN1:POL POS

DIG:PIN1:POL NEG

Trigger output

Any of the Digital Control pins can be programmed to function as a trigger output. All pins are referenced to the Signal Common pin.

When configured as a trigger output, the designated trigger pin will generate a 10-microsecond trigger pulse in response to a trigger event. The polarity setting can be either positive-going (rising edge) or negative-going (falling edge) when referenced to common.

Trigger out signals can be generated when configuring the voltage and current in the Input LIST. If you check the BOST and EOST boxes when configuring the Input LIST, an output trigger signal will be generated on the configured digital pin at the start and end of the voltage and current step.

From the front panel:

1. Press **Utilities** > **I/O Config** > **Digital IO** to access the Digital I/O window.
2. Select the pin you wish to configure. For example, press **Pin 1** to configure Pin 1.
3. Press **Function** and select **Trigger Out**. Select and program the remaining pins in the same manner. Press **Back** to return to previous page.
4. Configure the polarity for each of the pin. Press **Polarity Pos** to select Positive and **Polarity Neg** to select Negative. Select and program the remaining pins in the same manner.

From the remote interface:

To select the trigger output function:

DIG:PIN1:FUNC TOUT

To select the pin polarity:

DIG:PIN1:POL POS

DIG:PIN1:POL NEG

Input couple controls

This function lets you connect multiple Keysight EL30000 Series electronic loads together and synchronize the input on/off sequence across units. Each load that will be synchronized must have at least one coupled input.

1. Configure the inputs on each load as described under **Configuring the Input Turn-On/Turn-Off Sequence**. Set the input coupling mode to ON.
2. Set the delay offset of each individual unit to match the longest delay offset of the load's group.
3. Connect and configure the digital connector pins of the synchronized loads as described in this section.

NOTE

All synchronized EL30000 Series electronic loads must have the same firmware revision. Only pins 1 through 3 can be configured as synchronization pins. You cannot configure more than one On Couple and one Off Couple pin per electronic load. The polarity of the pins is not programmable; it is set to Negative.

The digital connector pins of the synchronized load that contain coupled inputs must be connected together as shown in the following figure. In this example, pin 2 will be configured as the input On control. Pin 3 will be configured as the input Off control. The ground or Common pins also need to be connected together.

Only two of the digital connector pins on each load can be configured as “On Couple” and “Off Couple” on each synchronized load. The designated pins will function as both an input and an output, with a negative transition on one pin providing the synchronization signal to the other pins.

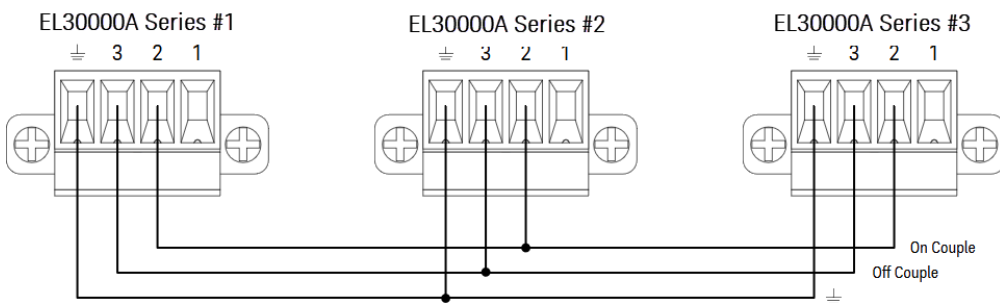

From the front panel:

1. Press **Utilities** > **I/O Config** > **Digital IO** to access the Digital I/O window.
2. Press **Pin 2**. Press **Function** and select **Couple On**.
3. Press **Pin 3**. Press **Function** and select **Couple Off**.
4. Repeat these steps for load #2 and #3.

From the remote interface:

To configure pin 2 of load #1 as the ON control:
DIG:PIN2:FUNC ONC

To configure pin 3 of load #1 as the OFF control:
DIG:PIN3:FUNC OFFC

Repeat these commands for load #2 and #3.

Operation

Once configured and enabled, turning the load input on or off on any coupled input will cause all coupled inputs on all configured loads to turn on or off according to their user-programmed delays. This applies to the front panel On and Off keys, the Web server, and to SCPI commands.

Turning the load inputs on or off using the front panel **[All On/Off]** key will cause all coupled inputs as well as non-coupled inputs on that load to turn on or off.

Using the Sequencer Function (EL34143A and EL34243A only)

LIST mode

Continuous mode

Pulse mode

Toggle mode

There are four types of sequencer mode: LIST, Continuous, Pulse, and Toggle.

Press **Sequencer** to select the sequencer type.



Press **Back** to return to Sequencer main menu.

LIST mode

LIST mode lets you generate complex sequences of input changes with rapid, precise timing, which may be synchronized with internal or external signals. This is useful when running test sequences with a minimum amount of programming overhead.

The Sequencer LIST allows single or multiple inputs to run in sequence. You can set the followings for each of the input in sequence.

1. Set the step that will generate the trigger out signal at the beginning/end of the step.
2. Set the last input value after the sequence list completes.
3. Set how the list responds to triggers.
4. Set the transient mode for voltage and current.
5. Set the trigger source for the transient system.
6. Set the trigger delay in seconds.
7. Set the list repeat count.
8. Set the list to repeat continuously.

You can configure up to 100 steps in the Sequencer LIST window.

Step 1 – Add/remove steps to/from the LIST

Press **Sequencer** to access the Sequencer LIST window.



Press **Add** to insert a new step below the selected step. Note that the values in the new step are copied from the previous step. Continue to add steps until your sequence is complete. Use the navigation keys to move through the list.

Press **Delete** if you want to delete the selected step or press **Clear All** if you want to remove all steps from the list.

Step 2 – Configure the input sequence

Configure the input sequence parameter accordingly. Use the navigation keys to select the field; use the numeric entry keys to enter the value. The value is set when you press **[Enter]**.

NOTE

When switching between operating modes, the load input parameter will change accordingly. For example, switching to CP mode will change the existing Current field to Power.



Fields	Description
Voltage	Sets the voltage, current, resistance, or power value for selected step in voltage, ampere, ohms, or watts.
Current	
Resistance	
Power	
Time	Sets the run-time for selected step in seconds.
BOST	Enables check box to set which step will generate a trigger-out signal at the beginning of the step (BOST).
EOST	Enables check box to set which step will generate a trigger-out signal at the end of the step (EOST).

For additional settings, press **Properties** to open the Sequencer LIST Properties window. Configure the Sequencer LIST accordingly. Refer to the below table for details.

Sequencer (List) Properties

Current After List: **Return to DC Value**

Pace: Dwell

Current Mode: Fixed

Trigger Source: List Run/Stop Key

Trigger Delay: 0.000

Repeat Count: 1

Continuous

Curr List: DC List | Pace: Dwl Trg | Curr Mode: Fix Stp Lst | Trig Src: Key IO Rmt | Continuous: Off On | Back

Settings	Available Key Settings	Description
Current After List Voltage After List Resistance After List Power After List	DC or List	<p>Specifies what happens when the input sequence completes. Default is DC.</p> <p><u>Action required:</u> Press Curr List, Volt List, Res List, or Pow List to toggle between DC and List.</p> <hr/> <p>DC (Return to DC Value) Returns to the DC value that was in effect before the input sequence started.</p> <hr/> <p>List (Last List Value) Remains at the last list value.</p>
Pace	Dwl or Trg	<p>Configures the pacing of the step. Default is Dwl.</p> <p><u>Action required:</u> Press Pace to toggle between Dwl and Trg.</p> <hr/> <p>Dwl(Dwell) The next step immediately inputs when the dwell time has elapsed.</p> <hr/> <p>Trg (Trigger) The next step immediately inputs when an external trigger is received. If the step time completes before trigger occurs, the step remains at the last list value while waiting for the trigger.</p>
Current Mode Voltage Mode Resistance Mode Power Mode	Fix, Stp, or Lst	<p>Sets the current/voltage/resistance/power mode. This determines what happens to the input current/voltage/resistance/power when the system is initiated or triggered. Default is Fix.</p> <p><u>Action required:</u> Press Curr Mode, Volt Mode, Res Mode, or Pow Mode to toggle between Fix, Stp, and Lst.</p> <hr/> <p>Fix (Fixed) Keeps the input at its immediate value.</p> <hr/> <p>Stp (Step) Steps the input to the triggered level when a trigger occurs</p> <hr/> <p>Lst (List) Causes the input to follow the list values when a trigger occurs.</p>

Settings	Available Key Settings	Description						
Trigger Source	Key, IO, or Rmt	<p>Sets the trigger source for the system. Default is Key.</p> <p><u>Action required:</u> Press Trig Src to toggle between Key, IO, and Rmt.</p> <hr/> <table border="0"> <tr> <td>Key (List Run/Stop Key)</td> <td>Selects the Run Stopped softkey as a trigger source.</td> </tr> <tr> <td>IO (DIO Trigger In)</td> <td>Selects any configured digital IO (with Trigger Input function) as a trigger source</td> </tr> <tr> <td>Rmt (Remote Command)</td> <td>Selects a remote interface command as a trigger source.</td> </tr> </table>	Key (List Run/Stop Key)	Selects the Run Stopped softkey as a trigger source.	IO (DIO Trigger In)	Selects any configured digital IO (with Trigger Input function) as a trigger source	Rmt (Remote Command)	Selects a remote interface command as a trigger source.
Key (List Run/Stop Key)	Selects the Run Stopped softkey as a trigger source.							
IO (DIO Trigger In)	Selects any configured digital IO (with Trigger Input function) as a trigger source							
Rmt (Remote Command)	Selects a remote interface command as a trigger source.							
Trigger Delay	0 to 0.255 s	Sets the trigger delay in seconds. Default is 0 s.						
Repeat Count	1 to 9999	Sets the list repeat count. This sets the number of times that a list is executed before it completes. Default is 1.						
Continuous	-	Enables check box to repeat the list continuously.						

Step 3 – Run the input sequence list

NOTE

When Sequencer LIST is initiated, all the List properties cannot be configured, which includes adding or removing step from the list.

When Step mode transient system is initiated, properties such as voltage mode, current mode, resistance mode, power mode, trigger source, and trigger delay cannot be configured.

If both Voltage and Current Mode is set to Fix and Trigger Source is set to Key, pressing **Run** will automatically set both voltage and current mode to List and start the list operation.

In this example, the load operation is in CC mode.

- Set Current Mode to List: Press **Curr Mode Lst**.
- Set Trigger Source to Key. Press **Trig Src Key**.
- Press the color-coded **[On]** key to enable the selected input.
- Press **Run** to start the list operation. To abort the operation, press **Stop**.
- Press **Back** to exit and return to the previous menu.

From the remote interface:

To configure the load operating mode to CC mode:

FUNC CURR, (@1)

To set the sequencer to LIST mode:

TRAN:MODE LIST, (@1)

To configure the List current of input 1 with 0.1 A, 0.2 V, 0.3 A, 0.4 A and 0.5 A:

LIST:CURR 0.1,0.2,0.3,0.4,0.5, (@1)

To configure all the List time of input 1 with 1 s:

LIST:DWELL 1,1,1,1,1, (@1)

To enable all the List BOST of input 1:

LIST:TOUT:BOST 1,1,1,1,1, (@1)

To disable all the List EOST of input 1:

LIST:TOUT:EOST 0,0,0,0,0, (@1)

To set the current mode of input 1 to List:

CURR:MODE LIST, (@1)

To set the trigger source of input 1 to Key/Immediate:

TRIG:SOUR IMM, (@1)

To enable input 1:

INP ON, (@1)

To initiate the transient operation sequence:

INIT:TRAN, (@1)

Continuous mode

Continuous mode generates repetitive pulse stream that toggles between two load levels.

The two load levels are main level (immediate or triggered) and transient level for current, voltage, power or resistance. The period, frequency and duty cycle of the continuous pulse train are programmable.

Step 1 – Configure the sequence properties

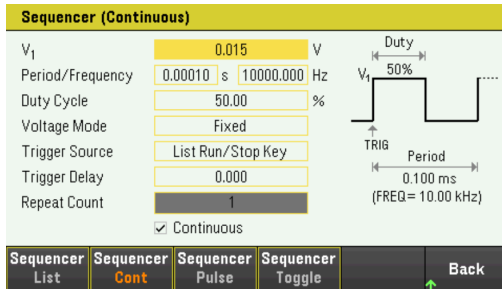

Configure the Sequencer Continuous accordingly. Refer to the below table for details.

Parameter	Available Key Settings	Description
Transient Setting (I_1 , V_1 , P_1 , or R_1)	minimum to maximum	Sets the transient voltage, current, resistance, or power level in voltage, ampere, ohms, or watts.
Period/Frequency	8μ to 4 s / 0.25 to 10000 Hz	Sets the transient frequency or period in Hz and seconds.
Duty Cycle	1.8 to 98.2%	Sets the transient duty cycle.
Current Mode	Fix, Stp, or Lst	Sets the current/voltage/resistance/power mode. This determines what happens to the input current/voltage/resistance/power when the system is initiated or triggered. Default is Fix. <u>Action required:</u> Press Curr Mode , Volt Mode , Res Mode , or Pow Mode to toggle between Fix, Stp, and Lst.
Voltage Mode		
Resistance Mode		
Power Mode		
		Fix (Fixed) Keeps the input at its immediate value.
		Stp (Step) Steps the input to the triggered level when a trigger occurs
		Lst (List) Causes the input to follow the list values when a trigger occurs.

Parameter	Available Key Settings	Description
Trigger Source	Key, IO, or Rmt	Sets the trigger source for the system. Default is Key. <u>Action required:</u> Press Trig Src to toggle between Key, IO, and Rmt.
	Key (List Run/Stop Key)	Selects the Run Stopped softkey as a trigger source.
	IO (DIO Trigger In)	Selects any configured digital IO (with Trigger Input function) as a trigger source
	Rmt (Remote Command)	Selects a remote interface command as a trigger source.
Trigger Delay	0 to 0.255 s	Sets the trigger delay in seconds. Default is 0 s.
Repeat Count	1 to 9999	Sets the list repeat count. This sets the number of times that a list is executed before it completes. Default is 1.
Continuous	-	Enables check box to repeat the list continuously.

Step 2 – Run the input sequence

In this example, the load operation is in CV mode.

- Set V_1 , period, frequency, duty cycle, trigger delay and repeat count accordingly: Use the navigation keys to select the field; use the numeric entry keys to enter the value. The value is set when you press **[Enter]**.
- Set Trigger Source to Key. Press **Trig Src Key**.
- Press the color-coded **[On]** key to enable the selected input.
- Press **Run** to start the sequence operation. To abort the operation, press **Stop**.
- Press **Back** to exit and return to the previous menu.

From the remote interface:

To configure the load operating mode to CV mode:
FUNC VOLT, (@1)

To set the sequencer to Continuous mode:
TRAN:MODE CONT, (@1)

To configure main voltage level with 5 V:
VOLT 5, (@1)

To configure the value for the transient voltage level with 10 V:
VOLT:TLEV 10, (@1)

To configure the transient frequency with 50 Hz:
TRAN:FREQ 50, (@1)

To configure the transient duty cycle with 10.5%:
TRAN:DCYC 10.5, (@1)

To configure trigger delay with 0.2 s:
TRIG:TRAN:DEL 0.2, (@1)

To configure the transient repeat count with 20:
TRAN:COUN 20, (@1)

To set the trigger source of input 1 to Key/Immediate:
TRIG:TRAN:SOUR IMM, (@1)

To configure the input voltage to follow transient value when a trigger occurs:
VOLT:MODE LIST

To enable input 1:
INP ON, (@1)

To initiate the transient operation sequence:
INIT:TRAN, (@1)

Pulse mode

Pulse mode generates a load change that returns to its original state after some time period.

It is similar to continuous operation with the following exceptions:

- To get a pulse, an explicit trigger is required.
- One pulse results from each trigger. Therefore, frequency cannot be programmed. The pulse width is programmable.

Step 1 – Configure the sequence properties

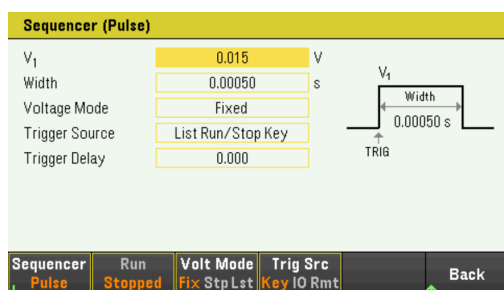

Configure the Sequencer Pulse accordingly. Refer to the below table for details.

Parameter	Available Key Settings	Description
Pulse Setting (I_1 , V_1 , P_1 , or R_1)	minimum to maximum	Sets the transient voltage, current, resistance, or power level in voltage, ampere, ohms, or watts.
Width	0.00005 to 268.435	The width of the pulse. Default is 0.0005 s.
Current Mode Voltage Mode Resistance Mode Power Mode	Fix, Stp, or Lst	Sets the current/voltage/resistance/power mode. This determines what happens to the input current/voltage/resistance/power when the system is initiated or triggered. Default is Fix. <u>Action required:</u> Press Curr Mode , Volt Mode , Res Mode , or Pow Mode to toggle between Fix, Stp, and Lst.
	Fix (Fixed)	Keeps the input at its immediate value.
	Stp (Step)	Steps the input to the triggered level when a trigger occurs
	Lst (List)	Causes the input to follow the list values when a trigger occurs.

Parameter	Available Key Settings	Description						
Trigger Source	Key, IO, or Rmt	<p>Sets the trigger source for the system. Default is Key.</p> <p><u>Action required:</u> Press Trig Src to toggle between Key, IO, and Rmt.</p> <hr/> <table border="0"> <tr> <td>Key (List Run/Stop Key)</td> <td>Selects the Run Stopped softkey as a trigger source.</td> </tr> <tr> <td>IO (DIO Trigger In)</td> <td>Selects any configured digital IO (with Trigger Input function) as a trigger source</td> </tr> <tr> <td>Rmt (Remote Command)</td> <td>Selects a remote interface command as a trigger source.</td> </tr> </table>	Key (List Run/Stop Key)	Selects the Run Stopped softkey as a trigger source.	IO (DIO Trigger In)	Selects any configured digital IO (with Trigger Input function) as a trigger source	Rmt (Remote Command)	Selects a remote interface command as a trigger source.
Key (List Run/Stop Key)	Selects the Run Stopped softkey as a trigger source.							
IO (DIO Trigger In)	Selects any configured digital IO (with Trigger Input function) as a trigger source							
Rmt (Remote Command)	Selects a remote interface command as a trigger source.							
Trigger Delay	0 to 0.255 s	<p>Sets the trigger delay in seconds. Default is 0 s.</p>						

Step 2 – Run the input sequence

In this example, the load operation is in CV mode.

- Set V_1 , pulse width, trigger delay and repeat count accordingly: Use the navigation keys to select the field; use the numeric entry keys to enter the value. The value is set when you press **[Enter]**.
- Set Trigger Source to Key. Press **Trig Src Key**.
- Press the color-coded **[On]** key to enable the selected input.
- Press **Run** to start the sequence operation. To abort the operation, press **Stop**.
- Press **Back** to exit and return to the previous menu.

From the remote interface:

To configure the load operating mode to CV mode:
FUNC VOLT, (@1)

To set the sequencer to Pulse mode:
TRAN:MODE PULS, (@1)

To configure main voltage level with 5 V:
VOLT 5, (@1)

To configure the value for the transient voltage level with 10 V:
VOLT:TLEV 10, (@1)

To configure the transient pulse width with 0.5 s :
TRAN:TWID 0.5, (@1)

To set the trigger source of input 1 to Key/Immediate:
TRIG:TRAN:SOUR IMM, (@1)

To configure the input voltage to follow transient value when a trigger occurs:
VOLT:MODE LIST

To enable input 1:
INP ON, (@1)

To initiate the transient operation sequence:
INIT:TRAN, (@1)

Toggle mode

Toggle mode generates a repetitive pulse stream that toggles between two load levels. It causes the load input to alternate between two pre-defined levels as in continuous operation except that the transient points are controlled by explicit triggers instead of an internal transient generator.

Step 1 – Configure the sequence properties

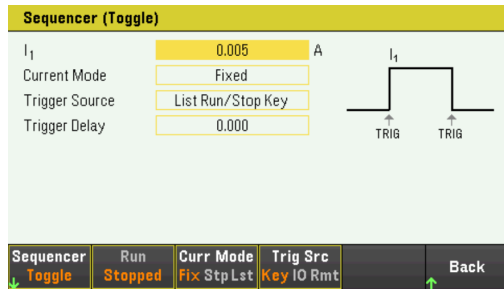

Configure the Sequencer Toggle accordingly. Refer to the below table for details.

Parameter	Available Key Settings	Description
Transient Setting (I_1 , V_1 , P_1 , or R_1)	minimum to maximum	Sets the transient voltage, current, resistance, or power level in voltage, ampere, ohms, or watts.
Current Mode Voltage Mode Resistance Mode Power Mode	Fix, Stp, or Lst	Sets the current/voltage/resistance/power mode. This determines what happens to the input current/voltage/resistance/power when the system is initiated or triggered. Default is Fix. <u>Action required:</u> Press Curr Mode , Volt Mode , Res Mode , or Pow Mode to toggle between Fix, Stp, and Lst.
		Fix (Fixed) Keeps the input at its immediate value.
		Stp (Step) Steps the input to the triggered level when a trigger occurs
		Lst (List) Causes the input to follow the list values when a trigger occurs.
Trigger Source	Key, IO, or Rmt	Sets the trigger source for the system. Default is Key. <u>Action required:</u> Press Trig Src to toggle between Key, IO, and Rmt.
		Key (List Run/Stop Key) Selects the Run Stopped softkey as a trigger source.
		IO (DIO Trigger In) Selects any configured digital IO (with Trigger Input function) as a trigger source
		Rmt (Remote Command) Selects a remote interface command as a trigger source.
Trigger Delay	0 to 0.255 s	Sets the trigger delay in seconds. Default is 0 s.

Step 2 – Run the input sequence

In this example, the load operation is in CC mode.

- Set I_1 , trigger delay and repeat count accordingly: Use the navigation keys to select the field; use the numeric entry keys to enter the value. The value is set when you press **[Enter]**.
- Set Trigger Source to Key. Press **Trig Src Key**.
- Press the color-coded **[On]** key to enable the selected input.
- Press **Run** to start the sequence operation. To abort the operation, press **Stop**.
- Press **Back** to exit and return to the previous menu.

From the remote interface:

To configure the load operating mode to CC mode:

```
FUNC CURR, (@1)
```

To set the sequencer to Toggle mode:

```
TRAN:MODE TOGG, (@1)
```

To configure the main current level with 5 A:

```
CURR 5, (@1)
```

To configure the value for the transient current level with 10 A:

```
CURR:TLEV 10, (@1)
```

To set the trigger source of input 1 to Key/Immediate:

```
TRIG:TRAN:SOUR IMM, (@1)
```

To configure the input voltage to follow transient value when a trigger occurs:

```
CURR:MODE LIST
```

To enable input 1:

```
INP ON, (@1)
```

To initiate the transient operation sequence:

```
INIT:TRAN, (@1)
```

Using the Data Logger Function

Logging data

Data logger view

Data logger marker view

Using the knob in data logger view

Data logger properties and waveform settings

Save the data log

The Data Logger allows you to view and log input voltage and current data for up to 10,000 hours (for single output, depending on the memory size) and up to 5 MB of data.

You can configure the Data Logger View to display voltage or current waveforms for all inputs. Once data logging completes, the data is automatically stored to a file named default.dlog.

Logging data

In the following data log example, a user-defined arbitrary waveform is captured on the data logger. The data logger records the actual input current of the arbitrary waveform.

Step 1 – Set the load operating mode to CC

Press **Mode** > **Mode CC**.

Step 2 – Program the input current values

In Meter View, set the input current of input 1 to 1 A. This is described under **Controlling the Inputs**.

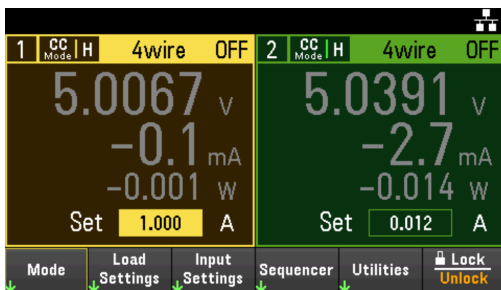

Step 3 – Program the sequence for the input channels

Configure the input sequence as described under **Using the Sequence LIST**.

Program the input current and time values as follows:

Step 0: 0.5 A; 1 s

Step 1: 1 A; 1 s

Step 2: 2 A; 1 s

Step 3: 3 A; 1 s

Step 4: 4 A; 1 s

Current After List: Return to DC Value

Pace: Dwell

Current Mode: List

Trigger Source: List Run/Stop Key

Continuous checkbox: Enabled

Step	Current	Time	BOST	EOST
0	0.500	1.000	<input type="checkbox"/>	<input type="checkbox"/>
1	1.000	1.000	<input type="checkbox"/>	<input type="checkbox"/>
2	2.000	1.000	<input type="checkbox"/>	<input type="checkbox"/>
3	3.000	1.000	<input type="checkbox"/>	<input type="checkbox"/>
4	4.000	1.000	<input type="checkbox"/>	<input type="checkbox"/>

* Long press [Delete] key to clear all the list.

Sequencer Run Add Delete Properties Back
List Stopped

Current After List	Return to DC Value
Pace	Dwell
Current Mode	List
Trigger Source	List Run/Stop Key
Trigger Delay	0.000
Repeat Count	1
	<input checked="" type="checkbox"/> Continuous

Curr List Pace Curr Mode Trig Src Continuous Back
DC List Dwl Trg Fix Stp Lst Key IO Rmt Off On

Step 4 – Configure the data logger traces

- Uncheck V2. On the data logger display, use the navigation keys to select V2 and press [Enter].
- Set V1 to 50 mV/Div. Set the knob function by pressing **Vertical Scale** and use the Vertical knob to adjust the V1 value accordingly.

Traces are color coded according to input. The ground symbol on the right side of the display indicates the ground reference of the trace.



Step 5 – Configure the data logger properties

Press **Properties** to display the Data Logger properties field.

- Leave the default Duration and Sample Period at 30 s and 200 ms respectively.
- Set the Trigger Source to Run/Stop Key. Press **Trigger Settings** > **Trigger Source** > **Run Key**.

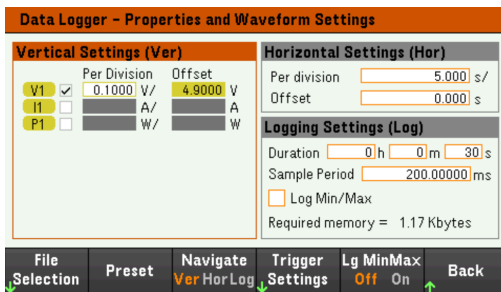

Step 6 – Configure and enable the DUT output accordingly

Step 7 – Turn on Input 1, start the sequencing and log the data

Press **Back** to return the display to the data logger view.

- Press Input 1 **[On]** to turn on Input 1.
- Press **Datalog Run** to run the data logger. The data logger will be initiated and Input 1 trace is displayed on the screen.
- Press **Sequencer** > **Sequencer LIST** > **Run** to start input sequencing. Alternatively, press **[List Run/Stop]**.

The data logger will run for 30 seconds and log the voltage data from input 1. When the data log completes, press **Auto Scale**. You should see the input waveform displayed as follows:

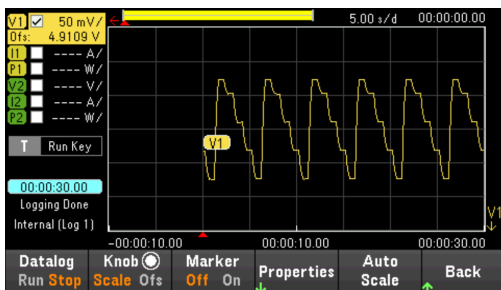

A message will indicate that the logged data has been saved in a file named default.dlog. If you wish to save the data under a different filename, you must specify the filename before the data logger runs.

Press **File Name** located at the data logger Properties menu to specify a filename.

Step 8 – Export the data

After you have completed the data logging, you can use the **Export File** key to export the logged data to a .csv (comma separated values) file.

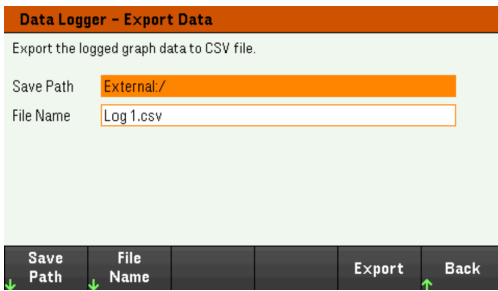

When exporting the data, specify the output you want to export the logged data.

Press **Save Path** to browse and specify the location where the export file will be placed. Use the front-panel navigation keys to navigate through the list. The left and right arrows contract or expand a folder to hide or show its files. Press **Select** once you have specified the path or **Cancel** to abort the changes made.

Press **File Name** to configure the filename. Use the keyboard to enter your desired filename in the File Name field. Press **Back** to save or **Cancel** to abort the changes made.

Press **Export** to export the file.

From the remote interface:

To set input 1 to CC mode:
FUNC CURR, (@1)

To set the input 1 to 1 A:
CURR 1, (@1)

To program input sequence of five steps on input 1:
LIST:CURR 0.5,1,2,3,4, (@1)
LIST:DWEL 1,1,1,1,1, (@1)
LIST:COUNT INF, (@1)
LIST:STEP AUTO, (@1)
CURR:MODE LIST, (@1)

To initiate the trigger system:
TRIG:SOUR BUS
INIT (@1)

To set up the data log for input 1:
SENS:DLOG:FUNC:VOLT 1, (@1)
SENS:DLOG:TIME 30
SENS:DLOG:PER 0.2





To initiate that data logger and specify the filename in which to save the data:
TRIG:DLOG:SOUR BUS
INIT:DLOG "External:\log1.csv"

To turn on Input 1 and run the data logger:
INP ON, (@1)
*TRG

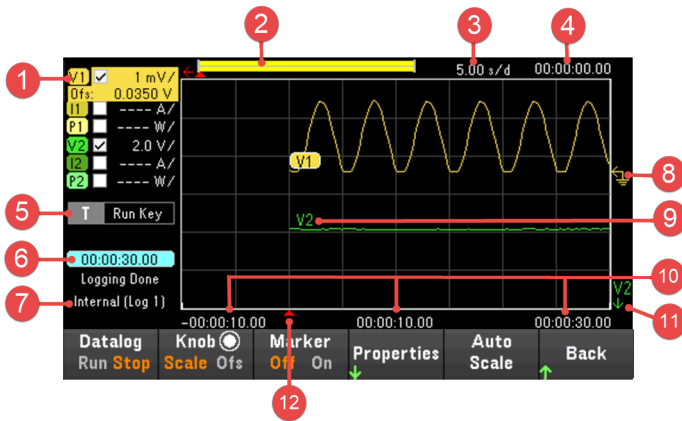
Data logger view

Press **Data Logger** to access the data logger.



Items	Description
1 Trace controls	Identifies the voltage or current trace that will be displayed. ✓ indicates the trace is on. Dashes (----) indicate the trace is off. Select the trace and press [Enter] to turn it on or off.
2 Data bar 	The data bar represents all of the logged data. The yellow part indicates the portion of the data that is visible on the display. The black part represents the data that is not visible.
3 Time/Div	Identifies the horizontal time-base setting. This can be adjusted using the Horizontal knob after pressing Knob Sc .
4 Offset time	Indicates the time that the right gridline is offset or away from the end of the data log. When this value is zero, it means that the right gridline is positioned at the end of the data log. Adjusting the offset will move the grid away from the end of the data log, as indicated by the Offset Time. The offset can be adjusted using the Horizontal knob after pressing Knob Ofs .
5 Trigger source	Indicates the trigger source for the data logger.
6 Time elapsed	Indicates the time elapsed during the data log and the total duration. The values match when data logging finishes.
7 Filename	Indicates the filename of the data that is being logged.
8 Ground reference 	The ground reference of the trace. Ground references are offset so that they do not overlap. The ground reference offset value is referenced to the horizontal center line of the grid.
9 Data traces	Voltage trace labels appear on the left side of the grid (V1 and V2) as shown in the display. Current trace labels appear on the right side of the grid (I1 and I2). Power trace labels appear on the center of the grid (P1 and P2). Press Auto Scale to auto-scale the data traces.
10 Grid time	Displays the time on the gridline.
11 Out of view arrows 	Indicate that the trace, V2 in the figure, is out of view. Press Knob Sc or Knob Ofs and use the Vertical knob to bring the trace into view. Press Auto Scale to autoscale the data traces.
12 Trigger point indicator 	Indicates the trigger position in the data log. In this example the trigger point was offset by 0%, and the pre trigger and post trigger data was logged. The time at the trigger point is always zero. Change the trigger offset in the Data Logger Logging Settings.

Menu	Description
Datalog Run Stop	Run or stop data logging.
Knob	Scale or OfS
	Sc, OfS, or Mrk
Marker	On or Off
Properties	Sets the data logging and waveform displays properties. See Data logger properties and waveform settings .
Auto Scale	Auto scales the traces on the display.

Data logger marker view



Items	Description
1 m1/m2 points	Shows where the measurement markers intersect the selected waveform. Data values at the bottom of the display are referenced to the intersect locations of the markers. Calculations are based on the data points in between the intersect locations.
2 m1	Indicates the m1 marker value in volts, amps, or watts at the intersection point. Also indicates the distance in time of the m1 marker in relation to the present trigger position. If a marker is out of view, an arrow indicates the direction of the marker < m1 .
3 m2	Indicates the m2 marker value in volts, amps, or watts at the intersection point. Also indicates the distance in time that the m2 marker is in relation to the present trigger position. If a marker is out of view, an arrow indicates the direction of the marker m2 > .
4 Delta	Indicates the delta or absolute difference between the markers in units (volts, amps, or watts) and in time (seconds).

Using the knob in data logger view

The **Knob** softkey in Data Logger view determines the function for both Vertical and Horizontal knob.

Marker Off



Marker On



Knob control settings	Knob	Description
Scale or Sc	Vertical knob	Makes the waveform bigger or smaller vertically in relation to its ground reference. Specified in volts/division, ampere/division and watts/division on the y axis.
	Horizontal knob	Stretches or shrinks the waveform horizontally around the timebase reference. Specified in time/division on the x axis. Applies to ALL traces.
Offset (Ofs)	Vertical knob	Moves the ground reference of the trace up or down in relation to the horizontal center line of the grid.
	Horizontal knob	Moves the waveform to the right or left of the timebase reference.
Marker (Mrk)	Vertical knob	Moves the m1 marker right or left.
	Horizontal knob	Moves the m2 marker right or left.

Using the knob for adjusting trigger level

Use the navigation keys to select the trigger level located on the left pane of data logger view, as shown below.

Adjusting the Vertical or Horizontal knob will adjust the trigger level for Voltage level, or Current level accordingly.

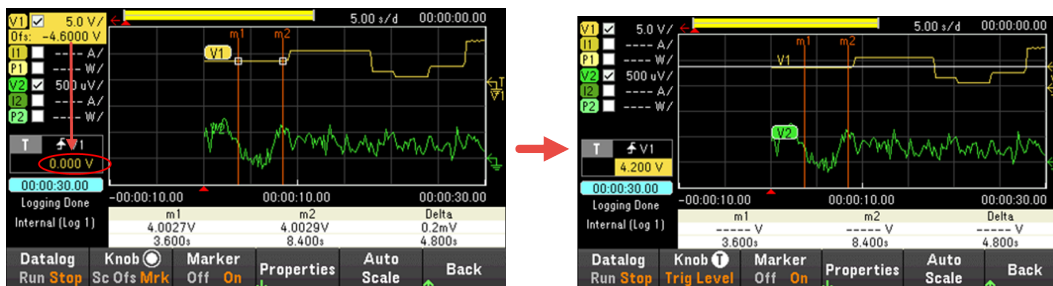

Data logger properties and waveform settings

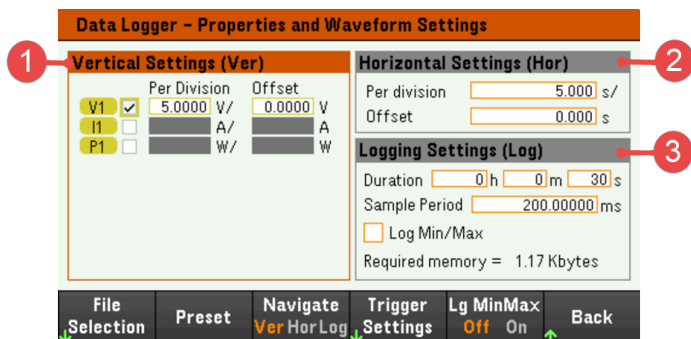

Items	Available settings	Description
1	Vertical Settings (Ver)	Trace checkbox Selects the trace to display for the input. If no checkbox is enabled, data logging will not be logged for the selected input. Configures the voltage/division, current/division, power/division and offsets for each input.
	Horizontal Settings (Hor)	Time/Division Configures to zoom in or out of the data so that you can view waveform details. The numbers on the top of the display indicate the location of the data that is being viewed relative to the entire data log. Specified in time/division on the x axis. Applies to ALL traces. Offset Configures the waveform location (right or left) of the timebase reference. The trigger point is indicated by the solid arrow  .
3	Logging Settings (Log)	Duration Configures the duration of the data log in hours, minutes, and seconds. The maximum duration is 10,000 hours. The logging information applies to data logger measurements on all inputs.
	Sample Period	Configures the interval between data samples in milliseconds, which can be set from 0.02048 microseconds to 60 seconds.
	Trigger Pos	Trigger Position specifies a trigger offset. This allows the specified time of pre-trigger data to be logged to the file. For example, if you specified a data log duration of 30 s and a trigger position of 50%, the Data Logger will log 15 s of pre-trigger data to the file before the trigger occurs. Subsequently, 15 s of post-trigger data will then be logged to the data file.
	Log Min/Max checkbox	When enabled, lets you log the minimum and maximum values of each sample to the data log file. With Log Min/Max checked, the resulting file size will triple.
	Required memory	Indicates the file size when the data log completes. The maximum file size is 5 MB. If settings exceed this limit, the logging interval will automatically increase to keep the size within the limit. If the file size exceeds the available space on the drive to which it will be written, an error is generated and the Data Logger will not run.

Menu	Available settings	Description
File Selection	-	Configures the file location and filename for logged data, export the file to .csv format and load the previously logged file to the instrument.
Preset	-	Returns the Data Logger View to the power-on display settings.
Navigate	Verr, Hor or Log	Selects the Vertical Settings, Horizontal Settings or Logging Settings field. <u>Action required:</u> Press Navigate to toggle between Ver, Hor and Log.

Trigger Settings >

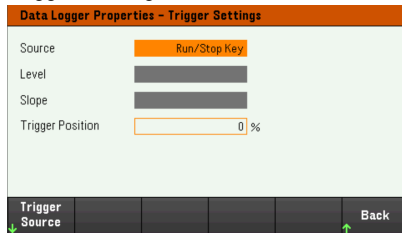

Trigger Source

V<1-2> Level,
I<1-2> Level, Run
Key, List Key,
On/Off, DIO or
Remote

Configures the trigger source.
Default is Run Key.

Action required:

Press **Trigger Source** to select a trigger source. This trigger source will trigger the data logging on all input channels.

V<1-2> Level	Selects the voltage trigger level as trigger source. Triggers the measurement when the voltage of the corresponding input passes through the specified level.
I<1-2> Level	Selects the current trigger level as trigger source. Triggers the measurement when the current of the corresponding input passes through the specified level.
Run Key (List Run/Stop Key)	Selects the Datalog Run Stop key as a trigger source.
List Key (List Run/Stop Key)	Selects the List Run/Stop key as a trigger source.
On/Off (Input On/Off Key)	Selects the Input On/Off keys as a trigger source. Also applies to the All Inputs On/Off key.
DIO (DIO Trigger In)	Selects any configured digital IO (with Trigger Input function) as a trigger source.
Remote (Remote Command)	Selects a remote interface command as a trigger source.

Level Specifies a trigger level if you selected a Voltage level or Current level as the trigger source. Along with the level, you must also specify a slope.

Slope Specifies if the measurement will be triggered on the positive (up-slope) or negative (downslope) portion of the waveform.

Trigger Positions Specifies a trigger offset. This allows the specified percent of pre-trigger data to be logged to the file. The trigger position is expressed as a percentage of the data log duration. For example, if you specified a data log duration of 30 minutes and a trigger position of 50%, the Data Logger will log 15 minutes of pre-trigger data to the file before the trigger occurs. Subsequently, 15 minutes of post-trigger data will then be logged to the data file.

Lg MinMax	Off or On	<p>Sets to enable or disable the Log Min/Max checkbox. Enabling the checkbox will log the minimum and maximum values to the data log file. With Log Min/Max checked, the resulting file size will triple.</p> <p>Default is Off.</p> <p><u>Action required:</u> Press Lg MinMax to toggle between Off and On.</p>
-----------	-----------	--

From the remote interface:

To enable current or voltage data logging on inputs 1 and 2:

```
SENS:DLOG:FUNC:CURR 1,(@1,2)
```

```
SENS:DLOG:FUNC:VOLT 1,(@1,2)
```

You cannot data log input power from the remote interface. To obtain power data, you need to data log both voltage and current and then calculate the power from the resulting voltage and current data.

To log the minimum and maximum values to the data log file for all enabled inputs:

```
SENS:DLOG:FUNC:MINM 1
```

To specify a data log of 1000 seconds on all enabled inputs:

```
SENS:DLOG:TIME 1000
```

To specify a sample period of 400 milliseconds between data samples on all enabled inputs:

```
SENS:DLOG:PER 0.4
```

To send an immediate trigger signal to the data logger:

```
TRIG:DLOG
```

To select the immediate trigger source (triggers the Data Logger immediately when initiated):

```
TRIG:DLOG:SOUR IMM
```

To select the rear panel trigger input (all connector pins that have been configured as trigger sources):

```
TRIG:DLOG:SOUR EXT
```

To select a BUS trigger source:

```
TRIG:DLOG:SOUR BUS
```

Save the data log

Press **File Selection** to choose between internal logging or external logging. Select **Int** to save the data into the internal memory or **Ext** to save the data into an external USB drive.

Internal logging

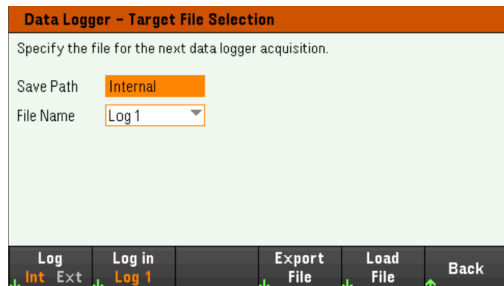

If you select the internal logging option, you will need to select the filename in which to save the data log – Log 1 or Log 2. Data will be logged to this filename the next time the Data Logger runs. If you do not specify a filename, the data will be logged to Log 1, which is overwritten each time the Data Logger runs.

Press **Log in** and use the arrow keys to select the desired filename (Log 1 or Log 2). Press **Log In** again to save your selection.

External logging

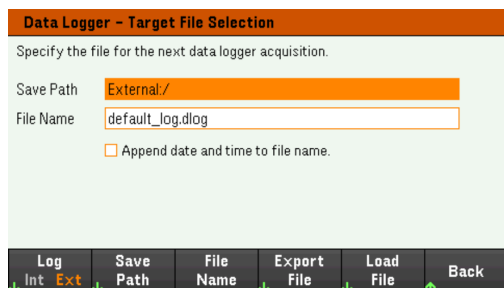

If you select the external logging option, you will need to specify a filename in which to save the data log. Data will be logged to this filename the next time the Data Logger runs. If you do not specify a filename, the data will be logged to default_log.dlog, which is overwritten each time the Data Logger runs.

Enable the **Append date and time to file name** checkbox to include timestamp information on the filename.

Press **Save Path** to browse and specify the location where the data log will be saved. Use the front-panel navigation keys to navigate through the list. The left and right arrows contract or expand a folder to hide or show its files.

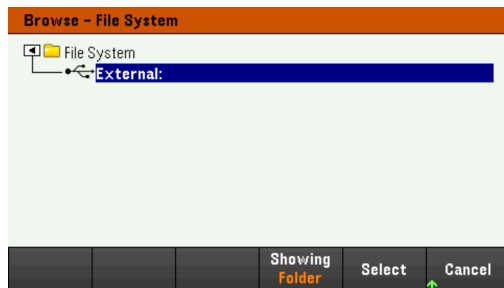

To view the available folder and files in the directory, press **Showing Folder** or **Showing All**. Press **Select** once you have specified the path or **Cancel** to abort.

Press **File Name** and use the keyboard to enter the filename in the File Name field. Press **Done** to save and **Cancel** to abort.

Filename

Select the **Filename** to specify a filename in which to save the datalog. Data will be logged to this filename the next time the Data Logger runs. If you do not specify a filename, the data will be logged to default_log.dlog, which is overwritten each time the Data Logger runs.



Export the data

NOTE

To export a data log that has been saved in the USB drive, you must first load the saved file into the data logger view.

Press **Export File** to export the data that is currently in the instrument's data log viewer to file. The exported data is in .csv format.

For details on how to specify the save location and filename, refer to [Save the Data Log](#).

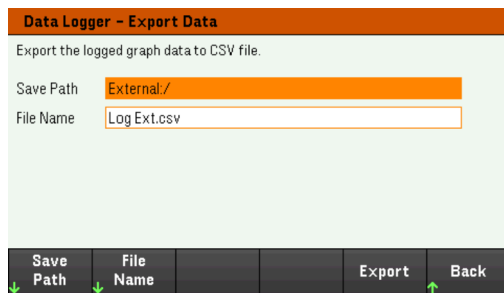

Load the data

NOTE

The file you load must be from same instrument model.

Press **Load File** to load the logged data to the instrument. You can load both binary files and data files in .csv format.

Data Logger - Load File

Please select the datalog file to be loaded.

Path

File

Browse **Load** **Back**

Press **Browse** to browse and select file from the directory. You can select from the internal memory or external memory (USB drive). Press **Select** to select the file or **Cancel** to abort.

Browse - File System

- File System
 - Internal:
 - External:

Showing All **Select** **Cancel**

Press **Load** to load the file.

Using the Scope Function

[Making measurement](#)

[Scope view](#)

[Scope marker view](#)

[Using the knob in scope view](#)

[Scope properties and waveform settings](#)

[Scope marker properties](#)

[Save the scope data](#)

The scope function is similar to a bench oscilloscope, displaying input voltage and current signals as a function of time. It has controls that select which inputs and functions to display, front panel knobs that adjust gain and offset, and configurable triggers and markers.

You can configure the Scope View to display voltage or current waveforms for all inputs. As explained under Horizontal Settings (Hr), the maximum sampling rate of the scope varies, depending on the number of waveforms that are displayed. Note that in the Scope View there is only one time-base and trigger configuration for all inputs.

Making measurement

In the following measurement example, an input turn-on sequence is displayed using the oscilloscope. The oscilloscope measures the actual current as the inputs turn on.

Step 1 – Set the load operating mode to CC

Press **Mode** > **Mode CC**.

Step 2 – Program the input current values

In Meter View, set the input current of input 1 to 1 A. This is described under [Controlling the Inputs](#).

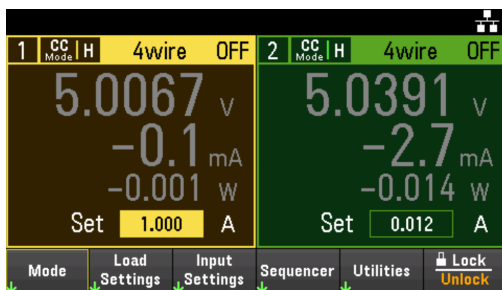

Step 3 - Configure the input turn-on sequence

Configure the input turn-on sequence as described under [Configuring the Input Turn-On/Turn-Off Sequence](#).

Note that you will only need to configure the Turn-on delays, not the turn-off delays.

The turn-on delays for the input channels are as follows:

- Input 1: 10 ms

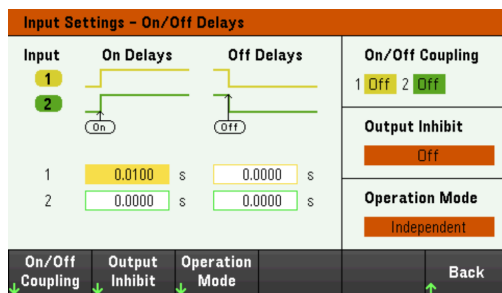

Step 4 - Configure the Scope View traces

- Uncheck V1 and V2.
- Check I1.
- Press **Knob Scale** and use the Vertical knob to set I1 to 1 A/Div.
- Press **Knob Ofz** and use the Vertical knob to set offset to 2 A.
- Press **Knob Scale** and use the Horizontal knob to set the timebase to 1 s.

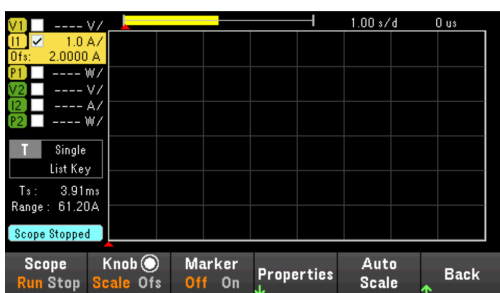

Step 5 – Configure the Scope properties:

Press **Properties** to configure the scope properties as follows:

- Press **Settings > Trigger Source > List Key** to select **[List Run/Stop]** key as a trigger source. Press **Back** to return to Settings menu.
- Press **Trigger Mode > Single** to display a single sweep measurement. Press **Back** twice to return to the Scope Properties menu.
- Set the Time Reference to Left in Horizontal Settings (Hr) window: Press **Settings > Time Ref Lf**.

Step 6 – Configure and enable the DUT output accordingly

Step 7 – Turn on the inputs and measure the current:

Press the **[Scope/Datalog]** key to return the display to scope view:

- Press the **Scope Run** key to run the scope. When this key is lit, it indicates that the scope is running.
- Press **[List Run/Stop]** to trigger the scope measurement.
- Press Input 1 **[On]** key to start the input sequence and trigger the scope.

You should see the input waveforms displayed as follows:

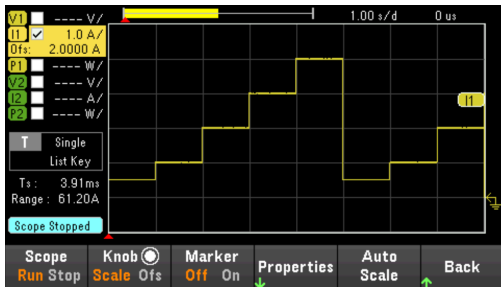





From the remote interface:



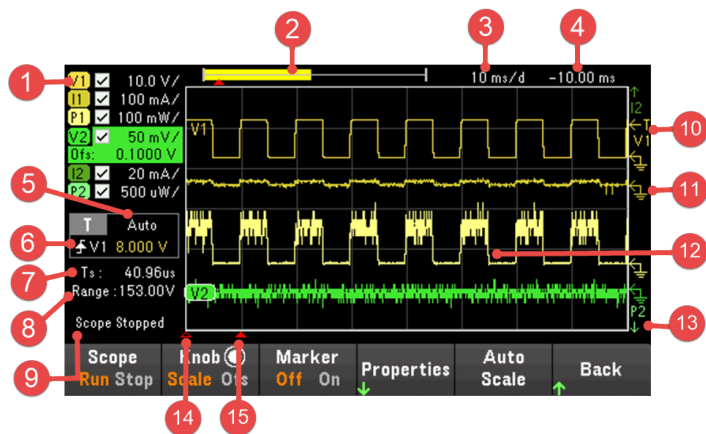

You cannot program the scope from the remote interface.

Scope View

Press [**Scope/Datalog**] key to view the scope. This key toggles between the Scope view and Data Logger view.



Items	Description
1	Trace controls Identifies the voltage or current that will be displayed. ✓ indicates the trace is on. Dashes (----) indicate the trace is off. Select the trace and press [Enter] to turn it on or off.
2	Data bar  The data bar represents all of the logged data. The yellow part indicates the portion of the data that is visible on the display. The black part represents the data that is not visible.
3	Time/Div Identifies the horizontal time-base setting. This can be adjusted using the Horizontal knob after pressing Knob Sc .
4	Offset time Indicates the time from the trigger point indicator to the vertical center line of the grid. Negative values indicate the center line is to the left of the trigger point. Positive values indicate the center line is to the right of the trigger point. The trigger point can be adjusted using the Horizontal knob after pressing Knob Of .
5	Trigger mode Indicates the trigger mode (Auto, Single, or Triggered).
6	Trigger Source   Up trigger indicates the measurement will be triggered on the up-slope (positive). Down trigger indicates the measurement will be triggered on the down-slope (negative). Amplitude If the trigger source is set to a voltage or current level, the amplitude of the trigger level is indicated below the trigger source. In the figure, the voltage trigger level is set to 0 V.
7	Sample period The indicated scope sample period is based on the horizontal time/div. setting. When the time/div. setting is less than 2 ms/division, the scope will sample at its fastest rate, depending on the number of traces selected: 1 trace: 5.12 microseconds 2 traces: 10.24 microseconds
8	Range Range indicates the measurement range setting of the selected trace.
9	Scope status Indicates whether the scope is Running, Stopped, or Waiting for a trigger.
10	Trigger level  Shows the location of the voltage or current trigger level and input. In this example, the voltage trigger level of input 1 is shown. The trigger source and amplitude are shown at the left corner of the display.

Items		Description
11	Scope traces	Voltage trace labels appear on the left side of the grid (V1 and V2) as shown in the display. Current trace labels appear on the right side of the grid (I1 and I2). Power trace labels appear on the center of the grid (P1 and P2). Press Auto Scale to auto-scale the data traces.
12	Ground reference 	The ground reference of the trace. Ground references are offset so that they do not overlap. The ground reference offset value is referenced to the horizontal center line of the grid.
13	Out of view arrows 	Indicate that the trace, P2 in the figure, is out of view. Press Knob Sc or Knob Of s and use the Vertical knob to bring the trace into view. Press Auto Scale to autoscale the data traces.
14	Horizontal reference 	Indicates the horizontal timebase reference. In the figure, the reference is centered. Change the reference justification in the Horizontal Settings field.
15	Trigger point indicator 	Shows the position of the trigger with respect to the waveform. In the figure, the trigger is offset to the left of the original point. The trigger point corresponds to the timebase reference when the offset is zero.
Menu		Description
Scope Run Stop		Run or stop data scope measurement.
Knob	Scale or Of	Set the function for the Vertical and Horizontal knob to adjust the vertical or horizontal waveform display. Toggle between Scale (Sc) and Offset (Ofs) for each waveform settings. See Using knob in scope view .
	Sc, Of, or Mrk	Marker (Mrk) only appear when Marker is enabled. Selecting Mrk set the function of the Vertical and Horizontal knob to adjust the m1 and m2 marker position. See Using knob in scope view .
Marker On or Off		Enables or disables the Marker view.
Properties		Sets the scope and waveform displays properties. See Scope properties and waveform settings .
Auto Scale		Auto scales the traces on the display.

Scope marker view

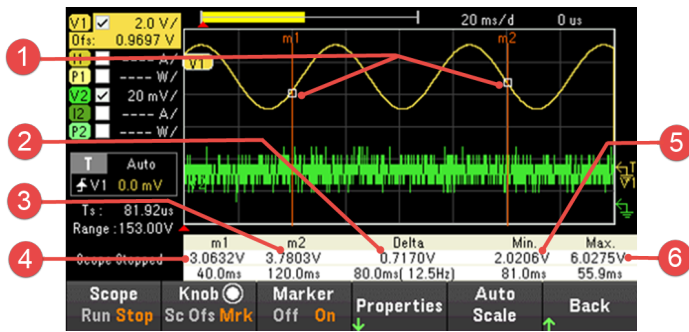

Items	Description
1 m1/m2 points	Shows where the measurement markers intersect the selected waveform. Data values at the bottom of the display are referenced to the intersect locations of the markers. Calculations are based on the data points in between the intersect locations.
2 Delta	Indicates the delta or absolute difference between the markers in units (volts, amps, or watts) and in time (seconds). The value in parenthesis is the frequency, which is the reciprocal of the time (1/time).
3 m2	Indicates the m2 marker value in volts, amps, or watts at the intersection point. Also indicates the distance in time that the m2 marker is in relation to the present trigger position. If a marker is out of view, an arrow indicates the direction of the marker m2 > .
4 m1	Indicates the m1 marker value in volts, amps, or watts at the intersection point. Also indicates the distance in time of the m1 marker in relation to the present trigger position. If a marker is out of view, an arrow indicates the direction of the marker < m1 .
5 Min	Indicates the minimum data value (in volts, amps, or watts) between the marker locations of the selected waveform. Also indicates the distance in time of the minimum value in relation to the present trigger position.
6 Max	Indicates the maximum data value (in volts, amps, or watts) between the marker locations of the selected waveform. Also indicates the distance in time of the maximum value in relation to the present trigger position.
7 Avg. (if selected)	Calculates the average data value (in volts, amps, or watts) between the marker locations of the selected waveform. Time indicates the time between markers over which the average value is calculated.
8 RMS (if selected)	Calculates the rms value between the marker locations.
9 Vp-p (if selected)	Calculates the difference between the maximum and minimum values. Time information is not valid for calculated p-p values.

Using the knob in scope view

The **Knob** softkey in Scope view determines the function for both Vertical and Horizontal knob. See table below for available settings.

Marker Off



Marker On



Knob control settings	Knob	Description
Scale or Sc	Vertical knob	Makes the waveform bigger or smaller vertically in relation to its ground reference. Specified in volts/division, ampere/division and watts/division on the y axis.
	Horizontal knob	Stretches or shrinks the waveform horizontally around the timebase reference. Specified in time/division on the x axis. Applies to ALL traces.
Offset (Ofs)	Vertical knob	Moves the ground reference of the trace up or down in relation to the horizontal center line of the grid.
	Horizontal knob	Moves the waveform to the right or left of the timebase reference.
Marker (Mrk)	Vertical knob	Moves the m1 marker right or left.
	Horizontal knob	Moves the m2 marker right or left.

Using the knob for adjusting trigger level

Use the navigation keys to select the trigger level located on the left pane of scope view, as shown below.

Adjusting the Vertical or Horizontal knob will adjust the trigger level for Voltage level, or Current level accordingly.

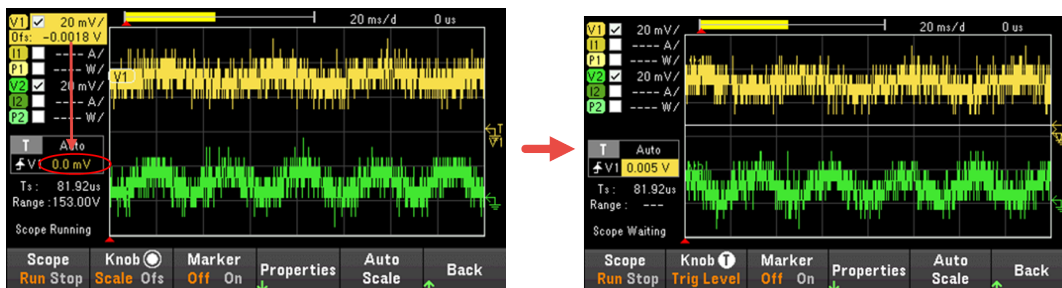

Scope properties and waveform settings

NOTE

There are no remote interface commands that correspond directly to the front panel Scope functions.

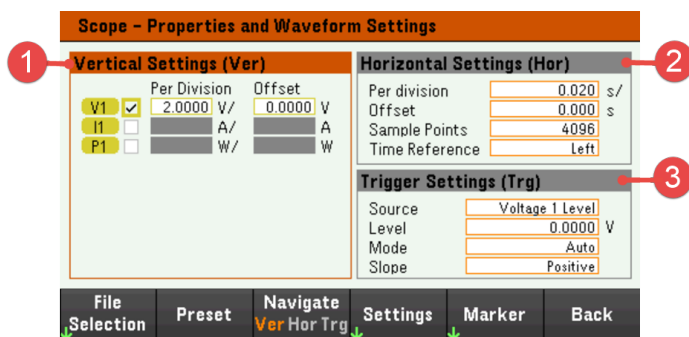

Items	Available settings	Description
1 Vertical Settings (Ver)	Trace checkbox	Selects the trace to display for the input. If no checkbox is enabled, no traces will be displayed for the selected input. Configures the voltage/division, current/division, power/division and offsets for each input.
2 Horizontal Settings (Hor)	Per division	Configures to zoom in or out of the data so that you can view waveform details. The numbers on the top of the display indicate the location of the data that is being viewed relative to the entire data log. Specified in time/division on the x axis. Applies to ALL traces.
	Offset	Configures the waveform location (right or left) of the timebase reference. The trigger point is indicated by the solid arrow  .
	Sample Points	Specifies the number of points in a scope trace. The maximum number of points that can be specified depends on the number of scope traces that have been enabled. The minimum number of points that can be specified is 1024. 1 trace enabled: 256 K points 2 traces enabled: 128 K points 4 traces enabled: 64 K points The power trace counts as 2 traces, since voltage and current must be measured to calculate power. If the voltage and current traces have already been selected, the Power trace is not counted.
	Time Reference	Specifies the reference point (right, left or center) on the scope display. This is the position of trigger if no offset has been set.
3 Trigger Settings (Trg)	Source	Specifies a trigger source. This trigger source will trigger the scope measurements on all input channels.
	Level	Specifies a trigger level if you select a Voltage level or Current level as the trigger source.
	Mode	Specifies a trigger mode.
	Slope	Specifies a trigger slope.

Menu	Available settings	Description
File Selection	-	Specifies the file location and filename for scope data, export the file to .csv format and load the previously saved scope data file to the instrument.
Preset	-	Returns the Scope View to the power-on display settings. The vertical offset of each trace will be set to a different value. This is to prevent the traces from overlapping. The offset is referenced to the horizontal center line of the grid.
Navigate	Ver, Hor or Trg	Selects the Vertical Settings, Horizontal Settings or Trigger Settings field. <u>Action required:</u> Press Navigate to toggle between Ver, Hor and Trg.

Settings	Sample Points	256k, 128k, 64k, 32k, 16k, 8192, 4098, 2048, or 1024	<p>Specifies the number of points in a scope trace. Default is 4096.</p> <p><u>Action required:</u> Press Sample Points to view and select the nine available sample points.</p>												
	Time Reference	Lf, Ctr or Rg	<p>Specifies the reference point on the display.</p> <p>This is the position of the trigger if no offset has been set.</p> <p>Default is Lf.</p> <p><u>Action required:</u> Press Time Ref to toggle between Lf, Ctr and Rg.</p> <table border="1"> <tr> <td>Lf (Left)</td> <td>Lets you see the waveform after the trigger event.</td> </tr> <tr> <td>Ctr (Center)</td> <td>Lets you see the waveform before and after the trigger event.</td> </tr> <tr> <td>Rg (Right)</td> <td>Lets you see the waveform up to the trigger event</td> </tr> </table>	Lf (Left)	Lets you see the waveform after the trigger event.	Ctr (Center)	Lets you see the waveform before and after the trigger event.	Rg (Right)	Lets you see the waveform up to the trigger event						
Lf (Left)	Lets you see the waveform after the trigger event.														
Ctr (Center)	Lets you see the waveform before and after the trigger event.														
Rg (Right)	Lets you see the waveform up to the trigger event														
	Trigger Source	V<1-2> Level, I<1-2> Level, List Key, On/Off, DIO or Remote	<p>Configures the trigger source.</p> <p>Default is Key.</p> <p><u>Action required:</u> Press Trigger Source to select a trigger source. This trigger source will trigger the scope measurements on all input channels.</p> <table border="1"> <tr> <td>V<1-2> Level</td> <td>Selects the voltage trigger level as trigger source. Triggers the measurement when the voltage of the corresponding input passes through the specified level.</td> </tr> <tr> <td>I<1-2> Level</td> <td>Selects the current trigger level as trigger source. Triggers the measurement when the current of the corresponding input passes through the specified level.</td> </tr> <tr> <td>List Key (List Run-/Stop Key)</td> <td>Selects the List Run/Stop key as a trigger source.</td> </tr> <tr> <td>On/Off (Input On/Off Key)</td> <td>Selects the Input On/Off keys as a trigger source. Also applies to the All Inputs On/Off key.</td> </tr> <tr> <td>IO (DIO Trigger In)</td> <td>Selects any configured digital IO (with Trigger Input function) as a trigger source.</td> </tr> <tr> <td>Remote (Remote Command)</td> <td>Selects a remote interface command as a trigger source.</td> </tr> </table>	V<1-2> Level	Selects the voltage trigger level as trigger source. Triggers the measurement when the voltage of the corresponding input passes through the specified level.	I<1-2> Level	Selects the current trigger level as trigger source. Triggers the measurement when the current of the corresponding input passes through the specified level.	List Key (List Run-/Stop Key)	Selects the List Run/Stop key as a trigger source.	On/Off (Input On/Off Key)	Selects the Input On/Off keys as a trigger source. Also applies to the All Inputs On/Off key.	IO (DIO Trigger In)	Selects any configured digital IO (with Trigger Input function) as a trigger source.	Remote (Remote Command)	Selects a remote interface command as a trigger source.
V<1-2> Level	Selects the voltage trigger level as trigger source. Triggers the measurement when the voltage of the corresponding input passes through the specified level.														
I<1-2> Level	Selects the current trigger level as trigger source. Triggers the measurement when the current of the corresponding input passes through the specified level.														
List Key (List Run-/Stop Key)	Selects the List Run/Stop key as a trigger source.														
On/Off (Input On/Off Key)	Selects the Input On/Off keys as a trigger source. Also applies to the All Inputs On/Off key.														
IO (DIO Trigger In)	Selects any configured digital IO (with Trigger Input function) as a trigger source.														
Remote (Remote Command)	Selects a remote interface command as a trigger source.														

Trigger Mode	Auto, Triggered or Single	Configures the trigger mode. Default is Auto. <u>Action required:</u> Press Trigger Mode to select a trigger mode.
	Auto	Configures the scope to display a single-sweep measurement when a trigger is received, or automatically if a trigger is not received. The scope continues running and waits for another trigger when the measurement completes.
	Triggered	Configures the scope to display a single-sweep measurement when a trigger is received. The scope stops running when the measurement completes.
	Single	Configures the scope to display a single-sweep measurement when a trigger is received. The scope continues running and waits for the next trigger when the measurement completes.
Slope	Pos or Neg	Configures the trigger slope. Default is Positive. <u>Action required:</u> Press Slope to toggle between Pos and Neg.
	Pos (Positive)	The measurement will be triggered on the positive (up-slope) portion of the waveform.
	Neg (Negative)	The measurement will be triggered on the negative (down-slope) portion of the waveform.
Marker	-	Select measurements to be displayed at the bottom of Marker view.

Scope marker properties

Press **Properties** > **Marker** to access the scope marker properties.

Use the navigation keys to select the measurements that appear on the bottom of the display in Marker view. Measurements apply to the portion of the waveform between the two markers. You can only select a maximum of three measurements to be displayed.

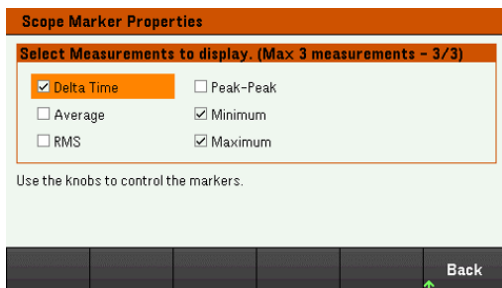

Save the scope data

Refer to [Save the data log](#) for information on how to save the scope data.

Locking/Unlocking the Front Panel

NOTE

If you are in a menu, you must exit the menu before locking the front panel.

1. Press and hold **Lock|Unlock** to lock the front panel. This produces lock icon(🔒) in the upper corner of the display, as shown below.

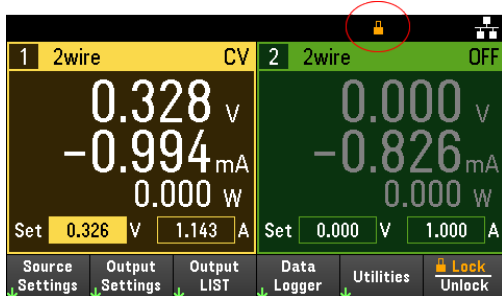

2. Press [**Lock|Unlock**] again to unlock the front panel.

From the remote interface:

To lock all front panel keys including **Lock|Unlock** key:

```
SYST:RWL
```

To lock all front panel keys except **Lock|Unlock** key:

```
SYST:REM
```

To unlock the front panel:

```
SYST:LOC
```

Capturing a Screen

Press [**Meter View**] for more than three seconds to capture a screen. The screen that was active will be saved to the USB flash storage connected to the front USB port.

To configure the screen capture storing path, refer to [Utilities Menu - Manage Files](#) for details.

Utilities Menu

Utilities provides the following features:



Store and recall state and power on settings

View USB and LAN status as well as configure LAN, GPIB (optional), and digital IO

Perform instrument self-tests, calibration, and configures the instrument's various user settings, date and time

Displays the instrument's error queue

Manage files, including creating screen shots

Utilities Menu - Store and Recall State

The Utilities menu is shown below.



Store/Recall saves and recall states. In general, state files store volatile settings associated with measurements.



The instrument states include volatile settings such as:

- Voltage, current, resistance, power, range, slew, mode, sense, short and current limit
- OCP delay, OCP state, OCP delay start, OPP state, OPP delay and UVI
- Input state and selected input
- Operation mode (Independent or Parallel)¹
- Input on/off sequencing
- Sequencer settings
- Trigger settings
- Digital I/O input data and bus setting
- Scope and data logger trigger source

1. Applicable for EL34243A only

Store Settings

Store Settings creates folders and files (.csv format) to store the instrument's state to the external memory, or to store the instrument's state to the internal memory.

Destination: Int allows you to store an instrument's state in the instrument's internal memory. You can store up to 10 separate states in the internal memory and set any one of them as the power-on state.

The screenshot shows the 'Store Settings' menu with the 'Internal' destination selected. The 'Store in' dropdown is set to 'State 0'. There is a checkbox for 'Set this as power-on state' which is currently unchecked. A note below states '* indicates current power-on state.' The bottom navigation bar includes 'Action: Store', 'Dest.: Int Ext', 'Store in: State 0', 'Set PwrOn: Yes No', 'Store', and 'Back'.

Menu	Available settings	Description
Action:	Store, Folder	Allows you to either store an instrument's state or to create a new folder.
Dest.:	Int, Ext	Selects whether you want to store an instrument's state in the internal or external memory. – Internal: The instrument's state is stored in the instrument's internal memory. – External: The instrument's state is stored in the external USB drive.
Store in	State 0 to State 9	Selects the state number to store the instrument's state.
Set PwrOn	Yes, No	Select 'Yes' to load the selected stored state upon power-on.
Store	-	Stores the state.

Destination: Ext allows you to store an instrument's state in the external USB drive inserted in the front panel's USB port. You can specify the path and filename of the stored state.

The screenshot shows the 'Store Settings' menu with the 'External' destination selected. There are two input fields for 'Path' and 'File'. The bottom navigation bar includes 'Action: Store', 'Dest.: Int Ext', 'Browse', 'File Name', 'Store', and 'Back'.

Menu	Available settings	Description
Action:	Store, Folder	Allows you to either store an instrument's state or to create a new folder.
Dest.:	Int, Ext	Selects whether you want to store an instrument's state in the internal or external memory. – Internal: The instrument's state is stored in the instrument's internal memory. – External: The instrument's state is stored in the external USB drive.
Browse	-	Allows you to browse and specify the location of the external memory to save the state.
Filename	-	Specifies the filename. Use the virtual keyboard to enter your desired filename.
Store	-	Stores the state.

Action: Folder creates a folder in the external memory.

Menu	Description
Browse	Allows you to browse and specify the location where the folder will be placed.
Folder Name	Specifies the folder name. Use the virtual keyboard to enter your desired folder name.
Create Folder	Creates a new folder in the specified location.

Recall Settings

NOTE

The file you recall must be from the same instrument model.

Recall Settings allows you to browse to the state in the internal memory or browse to the state file (.csv format) in the external memory to be recalled.

From: Int allows you to recall an instrument's state from the instrument's internal memory.

Menu	Available settings	Description
From:	Int, Ext	Selects whether you want to recall an instrument's state from the internal or external memory. <ul style="list-style-type: none"> – Internal: The instrument's state is recalled from the instrument's internal memory. – External: The instrument's state is recalled from the external USB drive.
Recall	State 0 to State 9	Select the state number that you want to recall from.
Recall	-	Recall the state.

From: Ext allows you to recall an instrument's state from the external USB drive inserted in the front panel's USB port.

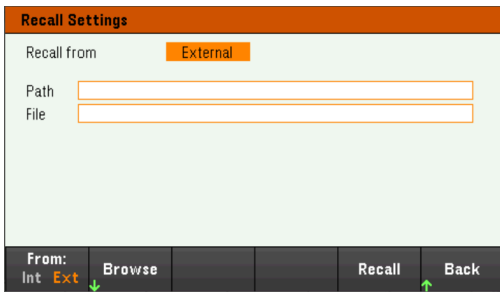

Menu	Available settings	Description
From:	Int, Ext	Selects whether you want to recall an instrument's state from the internal or external memory. - Internal: The instrument's state is recalled from the instrument's internal memory. - External: The instrument's state is recalled from the external USB drive.
Browse	-	Allows you to browse and specify the state file in the external memory to recall from.
Recall	-	Recall the state.

Power On Setting

Power On selects the state that will be loaded at power-up. This can be either the factory default state (Default), or user-defined states (State 0 to State 9).

Press **Set Power On** to save the setting.

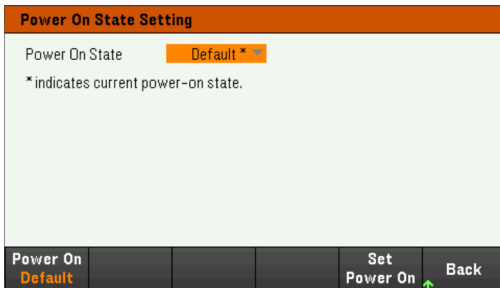

Set to Defaults

Set to Defaults loads the instrument's factory default state.

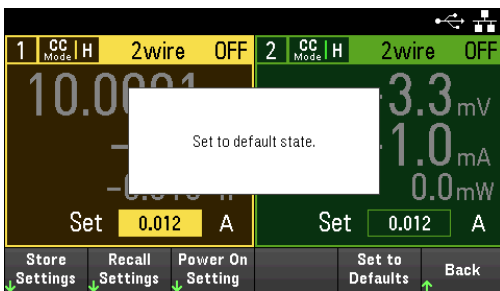

Utilities Menu - I/O Configuration



I/O Config configures the I/O parameters for remote operations over the LAN, USB, or GPIB (optional) interface.



USB Status displays the USB connect string for the instrument.

LAN Status displays the current LAN setting status for the instrument.

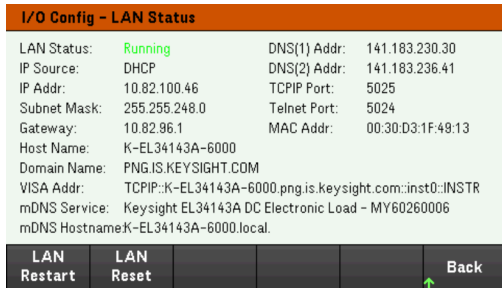

LAN Restart restarts the networking using its current LAN settings. LAN restart does not clear the user-defined Web Interface password.

LAN Reset resets the LAN using its current settings and enables DHCP and DNS. The **LAN Reset** softkey also clears any user-defined Web Interface password.

LAN Settings

LAN Settings opens the window shown below. **Set to Defaults** resets the LAN settings to their factory default values.

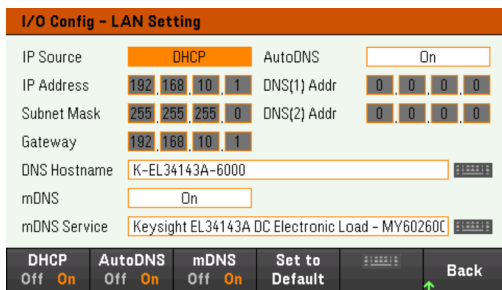

DHCP allows DHCP assignment of the instrument's IP address. It also enables the configuration of network parameters based on the protocol selected. **DHCP On** automatically assign a dynamic IP address to a LAN device.

AutoDNS allows assignment of the DNS addresses. **AutoDNS On** automatically configures the addressing of the instrument in DNS server

mDNS allows modification of the mDNS Service Name.

Hostname allows modification of the instrument's DNS hostname.

Digital IO

Digital IO configures the rear panel digital port's pin function, polarity and output data applied to the pin.

Pin selects the pin for configuration.

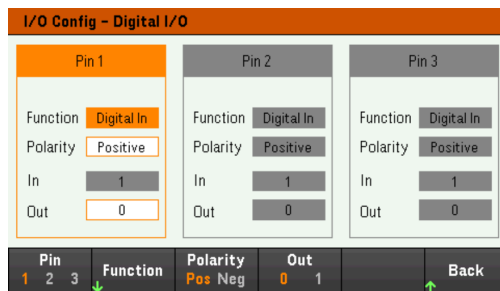

Functions configures the function for each pin as shown below.



Polarity configures the polarity to Positive (**POS**) or Negative (**NEG**) for the selected pin.

Out enables (**1**) or disables (**0**) the output data for the selected pin.

GPIO (optional)

GPIO allows you to set the GPIO address to a value from 0 to 30. After changing the address, cycle the instrument's power for the changes to take effect.



Utilities Menu - Test / Setup



Test / Setup provides access to calibration, self-test, as well as configures user preferences, sets the date and time, and accesses the help:



NOTE

MEMORY SANITIZATION PROCEDURE

Refer to the *EL30000 Series Security Guide* for instructions to perform a memory sanitization procedure that sanitizes all user-accessible instrument memory and restarts the instrument.

Calibration

Calibration accesses the instrument calibration procedure.

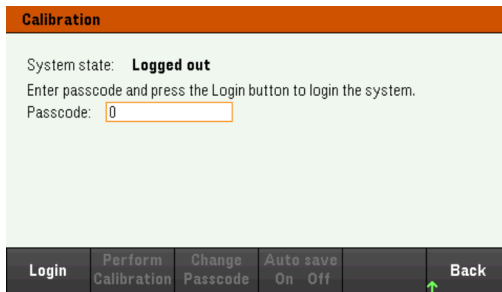

The default security passcode is 0. Press **Login** to access the calibration options.

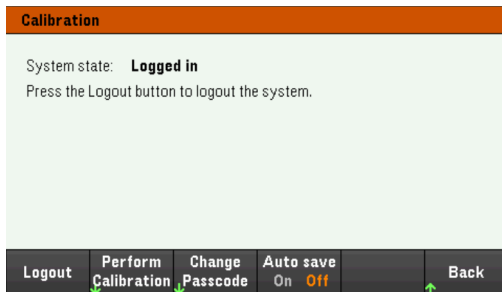

Perform Calibration opens the calibration menu. Make sure you have run the self-test before performing any calibration. Refer to "Calibration Adjustment Procedures" in the Service Guide for details.

Press **Change Passcode** to change the passcode using the numeric keypad. The passcode can be set up to 9 digits.

Auto save On will automatically save the calibration data upon logout. When **Auto save** is Off, press **Cal Save** to save the calibration data.

Self-Test

Self Test verifies proper instrument operation.

Self-Test Procedures

A power-on self-test occurs automatically when you turn on the electronic load. This limited test assures you that the electronic load is operational.

Press **Utilities** > **Test / Setup** > **Self Test** to perform the complete self-test of the electronic load. It takes approximately 2 seconds for the self-test to complete.

You can also perform a complete self-test from the remote interface, see the *EL30000 Series Programming Guide* for details.

- If the self-test is successful, "**Self test passed**" is displayed on the front panel.
- If the self-test fails, "**!Err**" is displayed on the front panel. Record the error code and message and contact Keysight support if necessary.
- If the self-test is successful, this indicates a high chance that the electronic load is operational.

User Settings

User Settings specifies user preferences that control how the user interacts with the instrument. These settings are stored in non-volatile memory.



Sound Settings

Beeper enables or disables the beeper sound when an error is generated from the front panel or remote interface.

Key Click enables or disables the click heard when a front-panel key or softkey is pressed.

Display Options

Display Options configures the display.



You can enable or disable the display and screen saver.

If you turn off the display, press any front-panel key to turn it on again.

By default, the screen saver turns off and blanks the screen after 30 minutes of inactivity. You may disable this screen saver from the front panel only.

The display is enabled when power is cycled, after an instrument reset (*RST), or when you return to local (front panel) operation. Press **Lock/Unlock** or execute the SYSTem:LOCal command from the remote interface to return to the local state.

You can also adjust the brightness of the display.

Help Lang selects the help language for front-panel use: English, French, German, Japanese, Korean, Simplified Chinese, or Russian. All front-panel key help, and help topics appear in the selected language. The softkey labels are always in English.

Date / Time

Date / Time sets the instrument's real-time clock, which always uses a 24-hour format (00:00:00 to 23:59:59). There is no automatic setting of the date and time, such as to adjust for daylight savings time.

Use the front panel navigation keys to set the year, month, day, hour, and minute.



Low Range

Low Range enables or disables low range current measurement.

Help

Help allows you to view the quick reference help topic. Use the arrow softkeys or front panel navigation keys to navigate the desired topic. Press **Select** to view the help content.

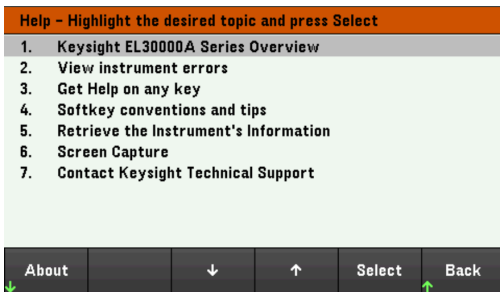

About allows you to view the instrument's model number, description, and serial number.

Utilities Menu - Error



Error displays the instrument's error queue, which includes up to 20 errors. If there are more than 10 errors on the display, press Next to scroll to the next page.



- Errors are stored in the order they are received. The error at the end of the list is the most recent error.
- If there are more than 20 errors in the queue, the last error stored is replaced with -350, "Queue overflow". No more errors are stored until you remove errors from the queue. If there are no errors, the instrument responds with +0, "No error".
- Except for self-test errors, errors are cleared when exiting the Error Log menu or when cycling power.

If you suspect that there is a problem with the electronic load, refer to "Troubleshooting" in the Service Guide.

Utilities Menu - Manage Files



Manage Files allows you to create, copy, delete, and rename files and folders on a USB drive attached to the front panel. It also allows you to capture the current screen to either a bitmap (*.bmp) or portable network graphics (*.png) file. This is the default option, as shown below.



Action

Action specifies the action to perform. Pressing **Capture Display** saves a screen capture of the display at the moment that you pressed **[Meter View]** for more than 3 seconds.



Delete - To delete a file or folder, press **Delete** and **Browse** to the folder or file to delete. Press **Browse** > **Perform Delete** > **Back**.

Folder - To create a folder, **Browse** to the external location for the folder, press **Folder Name**, enter a folder name and press **Done**. Press **Create Folder** > **Back**.

Copy - To copy a file, press **Copy**. **Browse** to the file to be copied and press **Select**. Press **Copy Path** and select an external path for copying. Press **Perform Copy** > **Back**.

Rename - To rename a file or folder, press **Rename**. **Browse** to the folder or file to be renamed and press **Select**. Press **New Name**, enter a new name and press **Done**. Press **Perform Rename** > **Back**.

Browse

Browse selects the file or folder upon which the action will be performed. Use the front-panel navigation keys to navigate through the list. The left and right arrows contract or expand a folder to hide or show its files.

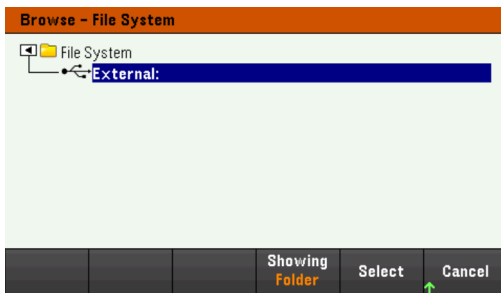

Press **Select** or **Cancel** to exit the browse window.

File Name

File Name allows you to use the front-panel arrows, the [Enter] key, and the softkeys to enter a filename. Use the front-panel arrows to point to a letter, and **Previous Char** and **Next Char** to move the cursor in the area where the name is entered. In the image below, there is no **Next Char** softkey because the cursor is at the end.



Press **Done** to confirm the new filename or **Cancel** to abort.

3 Characteristics and Specifications

NOTE

For the characteristics and specifications of the EL30000 Series DC electronic load, refer to the datasheet at <https://www.keysight.com/my/en/assets/3120-1430/datasheets/EL30000-Series.pdf>.

This information is subject to change
without notice.

© Keysight Technologies 2020
Edition 1, November 15, 2020
Printed in Malaysia



EL34243-90000

www.keysight.com

