

OPERATING INSTRUCTION

AUTORANGING MULTIMETER

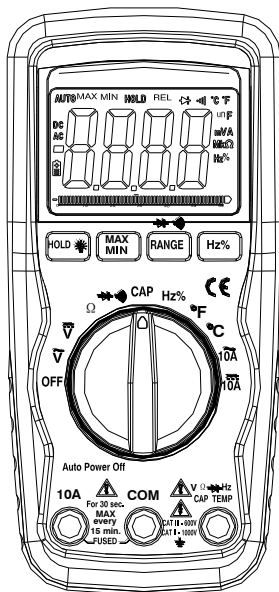

SAFETY INFORMATION

The following safety information must be observed to insure maximum personal safety during the operation at this meter:

- Do not use the meter if the meter or test leads look damaged, or if you suspect that the meter is not operating properly.
- Never ground yourself when taking electrical measurements. Do not touch exposed metal pipes, outlets, fixtures, etc., which might be at ground potential. Keep your body isolated from ground by using dry clothing, rubber shoes, rubber mats, or any approved insulating material.
- Turn off power to the circuit under test before cutting, unsoldering, or breaking the circuit. Small amounts of current can be dangerous.
- Use caution when working above 60V dc or 30V ac rms. such voltages pose a shock hazard.
- When using the probes, keep your fingers behind the finger guards on the probes.
- Measuring voltage which exceeds the limits of the multimeter may damage the meter and expose the operator to a shock hazard. Always recognize the meter voltage limits as stated on the front of the meter.

- Never apply voltage or current to the meter that exceeds the specified maximum:

SAFETY SYMBOLS



This symbol adjacent to another symbol, terminal or operating device indicates that the operator must refer to an explanation in the Operating Instructions to avoid personal injury or damage to the meter.



This **WARNING** symbol indicates a potentially hazardous situation, which if not avoided, could result in death or serious injury.



This **CAUTION** symbol indicates a potentially hazardous situation, which if not avoided, may result damage to the product.



This symbol advises the user that the terminal(s) so marked must not be connected to a circuit point at which the voltage with respect to earth ground exceeds (in this case) 500 VAC or VDC.



This symbol adjacent to one or more terminals identifies them as being associated with ranges that may, in normal use, be subjected to particularly

hazardous voltages. For maximum safety, the meter and its test leads should not be handled when these terminals are energized.

CONTROLS AND JACKS

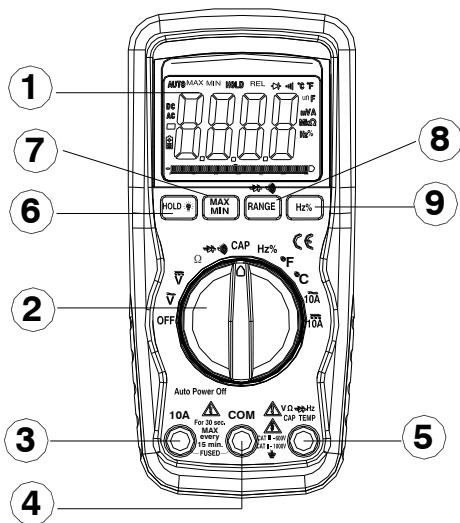

1. 6000 count Liquid Crystal Display with symbolic signs

2. Function switch
3. 10A (positive) input jack for 10A DC or AC measurements
4. COM (negative) input jack
5. Positive input jack
6. HOLD & Backlight pushbutton
7. Max/Min pushbutton
8. Range/  .Diode pushbutton
9. Hz/Duty pushbutton

SYMBOLS AND ANNUNCIATORS



Continuity

BAT

Low Battery



Diode

HOLD

Data Hold

AUTO

AutoRanging

AC

Alternating Current or Voltage

DC

Direct Current or Voltage

SPECIFICATIONS

The instrument complies with: EN61010-1.

Insulation: Class2, Double insulation.

Overvoltage category: CATIII 600V, CATII 1000V.

Display: 6000 counts LCD display with function indication.

Polarity: Automatic, (-) negative polarity indication.

Overrange: “OL” mark indication.

Low battery indication: The “BAT” is displayed when the battery voltage drops below the operating level.

Measurement rate: 2 times per second, nominal.

Auto power off: Meter automatically shuts down after approx. 15 minutes of inactivity.

Operating environment: 0 °C to 50 °C (32 °F to 122 °F) at < 70 % relative humidity.

Storage temperature: -20 °C to 60 °C (-4 °F to 140 °F) at < 80 % relative humidity.

For inside use, max height: 2000m

Pollution degree: 2

Power: One 9V battery , NEDA 1604, IEC 6F22.

Dimensions: 150 (H) x 70 (W) x 48 (D) mm

Weight: Approx.:255g.

Accuracy is given at 18 °C to 28 °C (65 °F to 83 °F), less than 70 % RH

DC Voltage

Range	Resolution	Accuracy
600.0mV	0.1mV	$\pm 0.5\%$ of rdg ± 2 dgts

6.000V	1mV	$\pm 1.2\%$ of rdg ± 2 dgts
60.00V	10mV	
600.0V	100mV	
1000V	1V	$\pm 1.5\%$ of rdg ± 2 dgts

Input Impedance: 7.8M Ω .

Maximum Input: 1000V dc or 1000V ac rms.

AC Voltage

Range	Resolution	Accuracy
6.000V	1mV	$\pm 1.2\%$ of rdg ± 3 dgts
60.00V	10mV	$\pm 1.5\%$ of rdg ± 3 dgts
600.0V	100mV	
1000V	1V	$\pm 2.0\%$ of rdg ± 4 dgts

Input Impedance: 7.8M Ω .

Frequency Range: 50 to 60Hz

Maximum Input: 1000V dc or 1000V ac rms.

DC Current

Range	Resolution	Accuracy
6A	1mA	$\pm 2.5\%$ of rdg ± 5 dgts
10A	10mA	

Overload Protection: 10A / 250V Fuse.

Maximum Input: 10A dc or ac rms on 10A DC range.

AC Current

Range	Resolution	Accuracy
6A	1mA	$\pm 3.0\%$ of rdg ± 5 dgts
10A	10mA	

Overload Protection: 10A / 250V Fuse.

Frequency Range: 50 to 60 Hz

Maximum Input: 10A dc or ac rms on 10A AC range.

Resistance

Range	Resolution	Accuracy
600.0 Ω	0.1 Ω	$\pm 1.2\%$ of rdg ± 4 dgts
6.000k Ω	1 Ω	$\pm 1.0\%$ of rdg ± 2 dgts
60.00k Ω	10 Ω	$\pm 1.2\%$ of rdg ± 2 dgts
600.0k Ω	100 Ω	
6.000M Ω	1k Ω	$\pm 2.0\%$ of rdg ± 2 dgts
60.00M Ω	10k Ω	$\pm 5.0\%$ of rdg ± 10 dgts

Maximum Input: 600V dc or 600V ac rms.

Capacitance (Auto-ranging)

Range	Resolution	Accuracy
40.00nF	10pF	$\pm 5.0\%$ of rdg ± 50 dgts
400.0nF	0.1nF	$\pm 3.0\%$ of rdg ± 5 dgts
4.000uF	1nF	
40.00uF	10nF	
400.0uF	0.1uF	$\pm 5.0\%$ of rdg ± 5 dgts
4000uF	1uF	$\pm 5.0\%$ of rdg ± 5 dgts

Maximum Input: 600V dc or 600V ac rms.

Frequency (Auto-ranging)

Range	Resolution	Accuracy
9.999Hz	0.001Hz	$\pm 1.5\%$ of rdg ± 5 dgts
99.99Hz	0.01Hz	
999.9Hz	0.1Hz	
9.999kHz	1Hz	$\pm 1.2\%$ of rdg ± 3 dgts
99.99kHz	10Hz	

999.9kHz	100Hz	
10MHz	1kHz	$\pm 1.5\%$ of rdg ± 4 dgts

Sensitivity: $>0.5V$ RMS while $\leq 1MHz$;

Sensitivity: $>3V$ RMS while $>1MHz$;

Maximum Input: 600V dc or 600V ac rms.

Duty Cycle

Range	Resolution	Accuracy
0.1%~99.9%	0.1%	$\pm 1.2\%$ of rdg ± 2 dgts

Pulse width: $>100\mu s$, $<100ms$;

Frequency width: 5Hz – 150kHz

Sensitivity: $>0.5V$ RMS

Maximum Input: 600V dc or 600V ac rms.

Temperature

Range	Resolution	Accuracy
$-20^{\circ}C \sim +760^{\circ}C$	$1^{\circ}C$	$\pm 3\%$ of rdg $\pm 5^{\circ}C/9^{\circ}F$
$-4^{\circ}F \sim +1400^{\circ}F$	$1^{\circ}F$	

Sensor: Type K Thermocouple

Overload protection: 600V dc or ac rms..

Diode Test

Test current	Resolution	Accuracy
0.3mA typical	1 mV	$\pm 10\%$ of rdg ± 5 dgts

Open circuit voltage: 1.5V dc typical

Overload protection: 600V dc or ac rms.

Audible continuity

Audible threshold: Less than 100Ω ; Test current: $<0.3\text{mA}$

Overload protection: 600V dc or ac rms.

OPERATION

WARNING: Risk of electrocution. High-voltage circuits, both AC and DC, are very dangerous and should be measured with great care.

1. ALWAYS turn the function switch to the OFF position when the meter is not in use. This meter has Auto OFF that automatically shuts the meter OFF if 15 minutes elapse between uses.
2. If “OL” appears in the display during a measurement, the value exceeds the range you have selected. Change to a higher range.

NOTE: On some low AC and DC voltage ranges, with the test leads not connected to a device, the display may show a random, changing reading. This is normal and is caused by the high-input sensitivity. The reading will stabilize and give a proper measurement when connected to a circuit.

AUTORANGING/MANUAL RANGE SELECTION

When the meter is first turned on, it automatically goes into

Autoranging. This automatically selects the best range for the measurements being made and is generally the best mode for most measurements. For measurement situations requiring that a range be manually selected, perform the following:

1. Press the **RANGE** key. The “**AUTO**” display indicator will turn off or select diode /beeper, AC/DC Clamp
2. Press the **RANGE** key to step through the available ranges until you select the range you want.
3. To exit the Manual Ranging mode and return to Autoranging, press and hold the **RANGE** key for 2 seconds.

Note: Manual ranging does not apply for the Frequency functions.

MAX/MIN

Note: When using the MAX/MIN function in Autoranging mode, the meter will “lock” into the range that is displayed on the LCD when MAX/MIN is activated. If a MAX/Min reading exceeds that range, an “**OL**” will be displayed. Select the desired range BEFORE entering MAX/MIN mode.

1. Press the **MAX/MIN** key to activate the MAX/MIN recording mode. The display icon "**MAX**" will appear. The meter will display and hold the maximum reading and will update only when a new “max” occurs.

2. Press the **MAX/MIN** key again and the display icon "**MIN**" will appear. The meter will display and hold the minimum reading and will update only when a new "min" occurs.
3. To exit MAX/MIN mode press and hold the **MAX/MIN** key for 2 seconds

DISPLAY BACKLIGHT

Press and hold the **HOLD** key for >1 second to turn on or off the display backlight function. The backlight will automatically turn off after 10 seconds.

HOLD

The hold function freezes the reading in the display. Press the **HOLD** key momentarily to activate or to exit the **HOLD** function.

Hz/duty

1. Switch to Hz/Duty range.
2. Press the Hz/Duty button to show the reading in the display and the "**Hz/Duty**" indicator will appear on the display.

DC VOLTAGE MEASUREMENTS

CAUTION: Do not measure DC voltages if a motor on the circuit is being switched ON or OFF. Large voltage surges may occur that can damage the meter.

1. Set the function switch to the V DC position .
2. Insert the black test lead banana plug into the negative (COM) jack and the red test lead banana plug into the positive (V) jack.
3. Touch the test probe tips to the circuit under test. Be sure to observe the correct polarity (red lead to positive, black lead to negative).
4. Read the voltage in the display. The display will indicate the proper decimal point and value. If the polarity is reversed, the display will show (-) minus before the value.

AC VOLTAGE MEASUREMENTS

WARNING: Risk of Electrocutation. The probe tips may not be long enough to contact the live parts inside some 240V outlets for appliances because the contacts are recessed deep in the outlets. As a result, the reading may show 0 volts when the outlet actually has voltage on it. Make sure the probe tips are touching the metal contacts inside the outlet before assuming that no voltage is present.

CAUTION: Do not measure AC voltages if a motor on the circuit is being switched ON or OFF. Large voltage surges may occur that can damage the meter.

1. Set the function switch to the V AC position.
2. Insert the black test lead banana plug into the negative (COM)

jack and the red test lead banana plug into the positive (V) jack.

3. Touch the test probe tips to the circuit under test.
4. Read the voltage in the display. The display will indicate the proper decimal point, value and symbol (AC, V, etc.).

DC CURRENT MEASUREMENTS

CAUTION: Do not make current measurements on the 10A scale for longer than 30 seconds. Exceeding 30 seconds may cause damage to the meter and/or the test leads.

1. Insert the black test lead banana plug into the negative (COM) jack.
2. For DC current measurements, set the function switch to the DC 10A position and insert the red test lead banana plug into the 10A jack.
3. Remove power from the circuit under test, then open up the circuit at the point where you wish to measure current.
4. Touch the black test probe tip to the negative side of the circuit. Touch the red test probe tip to the positive side of the circuit.
5. Apply power to the circuit.
6. Read the current in the display. The display will indicate the proper decimal point, value and symbol.

AC CURRENT MEASUREMENTS

WARNING: To avoid electric shock, do not measure AC current on

any circuit whose voltage exceeds 250V AC.

CAUTION: Do not make current measurements on the 10A scale for longer than 30 seconds. Exceeding 30 seconds may cause damage to the meter and/or the test leads.

1. Insert the black test lead banana plug into the negative (COM) jack.
2. For AC current measurements, set the function switch to the AC 10A position and insert the red test lead banana plug into the 10A jack.
3. Remove power from the circuit under test, then open up the circuit at the point where you wish to measure current.
4. Touch the black test probe tip to the negative side of the circuit. And touch the red test probe tip to the positive side of the circuit.
5. Apply power to the circuit.
6. Read the current in the display. The display will indicate the proper decimal point, value and symbol.



RESISTANCE MEASUREMENTS

WARNING: To avoid electric shock, disconnect power to the unit under test and discharge all capacitors before taking any resistance measurements. Remove the batteries and unplug the line cords.

1. Set the function switch to the Ω position.
2. Insert the black test lead banana plug into the negative (COM) jack and the red test lead banana plug into the positive Ω jack.
3. Touch the test probe tips across the circuit or part under test. It is best to disconnect one side of the part under test so the rest of the circuit will not interfere with the resistance reading.
4. Read the resistance in the display. The display will indicate the proper decimal point, value and symbol.

CONTINUITY CHECK



WARNING: To avoid electric shock, never measure continuity on circuits or wires that have voltage on them.

1. Set the function switch to the  position.
2. Insert the black lead banana plug into the negative (-) jack (COM) and the red test lead banana plug into the positive (+) jack (Ω).
3. Press the  button until the  symbol appears in the display.
4. Touch the test probe tips to the circuit or wire you wish to check.
5. If the resistance is less than approximately 100Ω , the audible signal

will sound. The display will also show the actual resistance.

DIODE TEST

WARNING: To avoid electric shock, do not test any diode that has voltage on it.

1. Set the function switch to  position.
2. Press the  button until the  symbol appears in the display.
3. Insert the black test lead banana plug into the negative (-) jack (COM) and the red test lead banana plug into the positive (+) jack (Ω).
4. Touch the test probe tips to the diode or semiconductor junction you wish to test. Note the meter reading

5. Reverse the probe polarity by switching probe position. Note this reading.
6. The diode or junction can be evaluated as follows:
 - A. If one reading shows a value and the other reading shows OL, the diode is good.
 - B. If both readings show OL, the device is open.
 - C. If both readings are very small or 0, the device is shorted.

NOTE: The value indicated in the display during the diode check is the forward voltage.

FREQUENCY MEASUREMENT

1. Set the function switch to the FREQ position.
2. Insert the black test lead banana plug into the negative (-) jack (COM) and the red test lead banana plug into the positive (+) jack (F).
3. Touch the test probe tips to the circuit under test.
4. Read the frequency in the display. The digital reading will indicate the proper decimal point, symbols (Hz, kHz) and value.

CAPACITANCE MEASUREMENTS

WARNING: To avoid electric shock, disconnect power to the unit under test and discharge all capacitors before taking any capacitance measurements. Remove the batteries and unplug the line cords.

1. Set the function switch to the CAP position. (“nF” and a small value will appear in the display).
2. Insert the black test lead banana plug into the negative (-) jack (COM) and the red test lead banana plug into the positive (+) jack (CAP).

Touch the test leads to the capacitor to be tested. The display will indicate the proper decimal point, value and symbol

TEMPERATURE MEASUREMENTS

WARNING: To avoid electric shock, disconnect both test probes from any source of voltage before making a temperature measurement.

1. If you wish to measure temperature in °F, set the function switch to the °F range. If you wish to measure temperature in °C, set the function switch to the °C range.
2. Insert the type K thermocouple probe black test lead banana plug into the negative **COM** jack and the red test lead banana plug into the positive **Temp** jack..
3. Touch the Temperature Probe head to the part whose temperature you wish to measure. Keep the probe touching the part under test until the reading stabilizes (about 30 seconds).
4. Read the temperature in the display. The digital reading will indicate the proper decimal point and value.

WARNING: To avoid electric shock, be sure the thermocouple has been removed before changing to another measurement function.

REPLACING THE BATTERY

WARNING: To avoid electric shock, disconnect the test leads from any source of voltage before removing the battery door.

1. When the batteries become exhausted or drop below the operating voltage, “BAT” will appear in the right-hand side of the LCD display. The battery should be replaced.
2. Follow instructions for installing battery. See the Battery Installation section of this manual.
3. Dispose of the old battery properly.

WARNING: To avoid electric shock, do not operate your meter until the battery door is in place and fastened securely.

BATTERY INSTALLATION

WARNING: To avoid electric shock, disconnect the test leads from any source of voltage before removing the battery door.

1. Disconnect the test leads from the meter.
2. Open the battery door by loosening the screw using a Phillips head screwdriver.
3. Insert the battery into battery holder, observing the correct polarity.
4. Put the battery door back in place. Secure with the two screws.

WARNING: To avoid electric shock, do not operate the meter until the battery door is in place and fastened securely.

NOTE: If your meter does not work properly, check the fuses and battery to make sure that they are still good and that they are properly inserted.

REPLACING THE FUSES

WARNING: To avoid electric shock, disconnect the test leads from any source of voltage before removing the fuse door.

1. Disconnect the test leads from the meter and any item under test.
2. Open the fuse door by loosening the screw on the door using a Phillips head screwdriver.
3. Remove the old fuse from its holder by gently pulling it out.
3. Install the new fuse into the holder.
4. Always use a fuse of the proper size and value (10A/250V fast blow for the 10A range).
5. Put the fuse door back in place. Insert the screw and tighten it securely.

WARNING: To avoid electric shock, do not operate your meter until the fuse door is in place and fastened securely.